

DEC '31
JAN '32

NOW
25¢

SHORT WAVE CRAFT

Edited by
HUGO GERNSBACK

IN THIS ISSUE

- "ORE LOCATING" BY SHORT WAVES
- SHORT WAVE LANDING BEAM FOR AIRPLANES
- HOW TO BUILD SIMPLE, LOW-PRICED SHORT WAVE RECEIVER
- HOW ARE SHORT WAVES PROPAGATED?
- ECONOMICAL MODULATORS FOR AMATEUR PHONE TRANSMITTERS
- CHECKING THE SHORT WAVE TRANSMITTER
- CONSTRUCTION OF S-W CONVERTER
- LATEST ULTRA SHORT WAVE DATA

ARTICLES BY

- L. Myton Eddy
- C. H. W. Nason
- H. Harrison
- A. Binneweg, Jr.
- Beryl B. Bryant

Jan.



How to Make the New All-Wave Receiver, Using 6.3 Volt "Auto" Tubes

EXCLUSIVE NEWS FROM

LINDBERGH PLANE FLYING OVER ARCTIC WILDERNESS, RECEIVED ON A LINCOLN RADIO

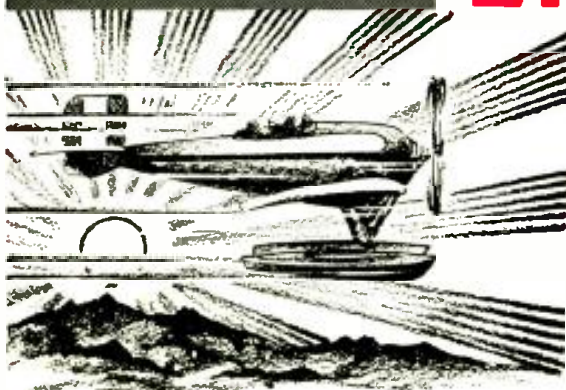

On the eve of August 5th, Roscoe H. Johnson, operator and owner of a powerful short-wave station, using a LINCOLN RECEIVER, had just finished his daily schedule of messages with the Bowdoin ship of the MacMillan expedition, now located off the shores of Baffin Land; turning his dials to the frequency of the Lindbergh transmitter, strong and clear came in the signals from the Lindbergh plane, flying over the Arctic circle. Realizing that this was the first message received for some time from the famous aviator and that the public were much concerned as to the safety of the plane, Mr. Johnson immediately phoned the United Press and in a flash it was headlined in newspapers throughout the world.

When the operator, in Chicago, turned his dials to the 20 meter band, the sharp clear note of the Lindbergh transmitter brought its message through the violent storms and electrical disturbances of the Arctic. Hundreds of amateur and commercial stations in all parts of the world were vainly combing the air for some news of the flying colonel and his wife. It remained for a LINCOLN receiver to catch the anxiously-awaited signal from the far north reassuring the world that all was well.

Such spectacular performance is an impressive tribute to the excellence of Lincoln equipment, and proves, in a conclusive manner, the outstanding superiority of Lincoln receivers.

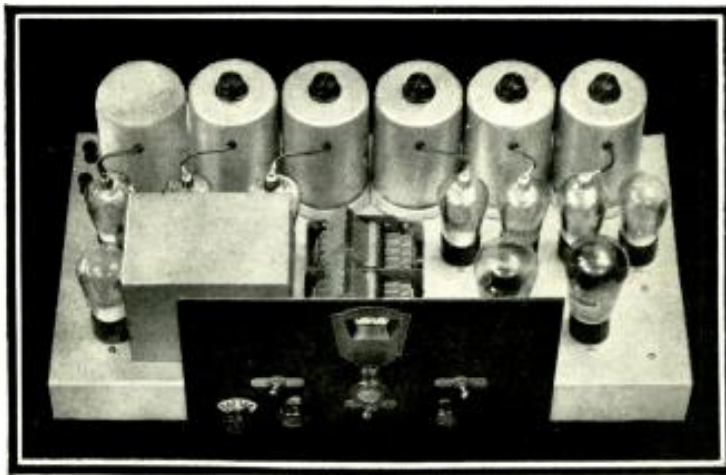

SUPER-POWERED, WORLD-WIDE RECEPTION 15 to 550 METERS- NO PLUG-IN COILS-WITH THE LINCOLN DE LUXE S-W 32 and DE LUXE D.C. SW 10

Now, you can sit comfortably in your easy chair and switch instantly from your local station to London, Paris, Rome, Nauen, Morocco, Saigon, Wellington—over 100 phone stations throughout the world. No plug-in coils, six screen-grid tubes in the highest amplifying system known WITH PERFECT 10 KC REJECTIVITY famous in Lincoln equipment for the last four years.

Turn the indicator to the desired band of frequencies and apply the full tremendous power of the DeLuxe to Short-Wave or Broadcast signals. Utilizing the tremendous amplification and rejectivity of the famous Lincoln tuned intermediate transformers, originated four years ago and perfected to a high degree, the DeLuxe brings in distant signals with tremendous volume with perfect rejectivity. A Lincoln owner in Tennessee listens to NINETY-TWO FOREIGN SHORT-WAVE STATIONS out of a total of 128 foreign phone stations. Old time "hams" and radio fans marvel at the tremendous volume available on signals thousands of miles away. Even in the Broadcast band, owners of Lincoln equipment located in the Central West are actually listening to stations 7,000 miles away with loud speaker volume. A report from Cushing, Oklahoma, states: "Seven stations received from Japan in one morning, all in the broadcast band." While another report reads: "Listening to 2YA Wellington, New Zealand, Osaka, Sendai, and Kumamoto, (750, 770 and 790 KC) in Japan, KGMC Honolulu, 2BL Sydney, Australia, all in the Broadcast Band." Do you wonder that Lincoln receivers are classed as the most powerful equipment in the world?

Do you wonder why Lincoln equipment out-performs any known receiver and is chosen by the Polar Expedition, Broadcasting Station, and individuals who want the best?

Months of intensive laboratory study has been put into these two new receivers. Capitalizing on years of advanced engineering developments, Lincoln engineers have worked out every detail of performance—Selectivity—Sensitivity—Fidelity and Stability, to work perfectly from frequencies of 15 to 550 meters. The tremendous amplification of the new models now applied to short-wave, as well as broadcast stations, gives a new conception of what is possible in radio.

MARVELOUS TONE QUALITY for which Lincoln equipment has so long been noted, is maintained. The heavy volume of the organ or orchestra can be brought into the home with realistic reproduction or tuned down to a whisper without destroying the quality and without a sign of AC hum.

EVERY RECEIVER IS LABORATORY BUILT, CONSTRUCTED BY COMPETENT ENGINEERS AND THOROUGHLY TESTED ON THE AIR BEFORE SHIPMENT.

THE LINCOLN DELUXE DC-SW-10

This receiver is designed for use with new low drain series 2-volt tubes, employing three '30 type, five '32 type and two '31 type in push-pull output. Will operate on any two volt "A" supply and dry "B" batteries. For quietness of operation due to elimination of AC line interference, the new DC DeLuxe gives perfect reproduction on extreme distance.

The Lincoln DeLuxe DC-SW-10 is without question the highest designed and most powerful battery receiver ever offered to the public.

LINCOLN RADIO CORPORATION
329 SO. WOOD ST. Dept. SWC-4
CHICAGO, ILLINOIS

Write today for Arctic Expedition Bulletins and Illustrated descriptive literature with attractive distributors' discount.

NAME

ADDRESS

“For 16 Weeks



I enjoyed every broadcast from

VK3ME

MELBOURNE, AUSTRALIA”

This is not a “freak” record. Hundreds of other Scott All-Wave Receivers—all summer long—have brought their owners loud, clear, perfect music and song from the other side of the world.

EVERY now and then, the story of some phenomenal instance of extremely long distance radio reception breaks into the press. DX fans usually find little interest in such stories because they know the performance which they relate is invariably due to “freak” conditions.

But DX fans KNOW, when my receiver brings in every broadcast from VK3ME for 16 consecutive weeks, that full credit must go to the receiver that did the work. And when they learn that hundreds of other receivers exactly like mine, and located in all parts of the world, are piling up equally sensational records, they are well satisfied that the Scott All-Wave is not only the most powerful, most sensitive receiver possible to obtain, but the one receiver that fulfills their lifelong hopes.

Undeniable Proof

Away last spring I made up my mind to eclipse all standards of radio reception—distance—power—selectivity and tone. I believed the Scott All-Wave would do it, so I set out to make a day-to-day log of VK3ME, Melbourne, 9560 miles away from my receiver. I tuned in every broadcast, on the loud speaker, and to prove to the entire world that I heard every VK3ME program with full volume, and with perfect tone and clarity, I made a disc recording of every broadcast! Half of these records I sent to VK3ME. The others are at my laboratory and will be played for anybody who asks to hear them.

Not a Special Set

The Scott All-Wave Receiver that you may buy, will in no way, differ from the one I used in my 16-week test. It will be identical to the hundreds of other Scott All-Wave Receivers that tune in voice from England, France, Germany, Italy, Japan, Indo-China, and South America every day in the week—summer and win-

E. H. SCOTT RADIO LABORATORIES, Inc. (Formerly Scott Transformer Co.)
4450 Ravenswood Avenue - Dept. SWC-12 Chicago, Illinois

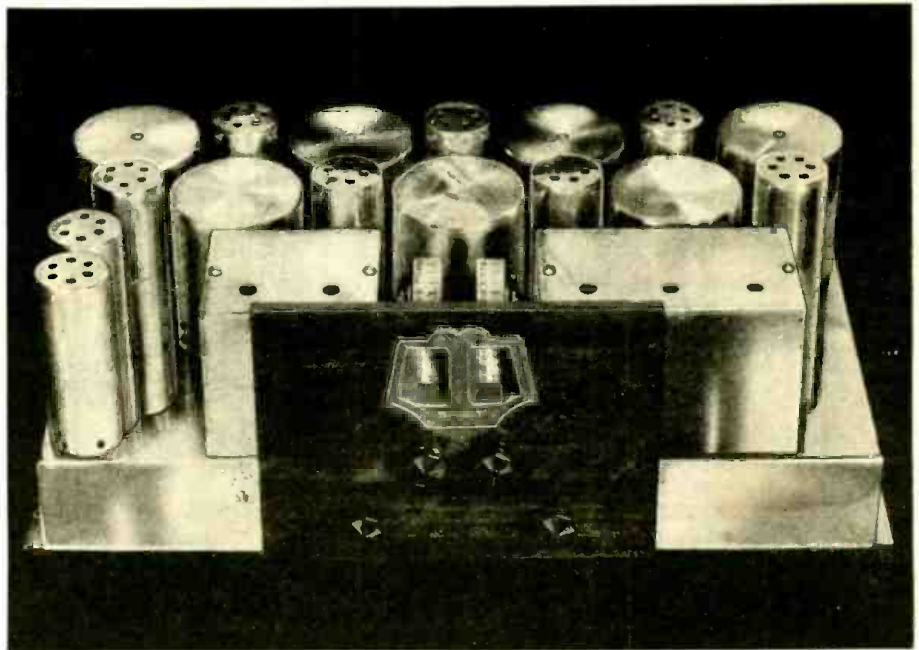

ter. The set that I will send to you will actually be tested on reception from G5SW, Chelmsford, England, or 12RO, Rome, Italy, before shipping!



This cablegram verifies the first 10 weeks' reception. To date there has not been time for my log of the last 6 weeks to reach Melbourne.

Another Challenge

Again, I challenge the whole world of radio to any kind of competitive test, between 15 and 550 meters. I guarantee that the Scott All-Wave will bring in the most stations between 15 and 550 meters—that the Scott All-Wave will leave no doubt as to superior tone quality—and that it will give actual 10 kilocycle selectivity over the Broadcast Band.

Clip the coupon—mail it today for full particulars. You'll be amazed when you see how little it costs to own a Scott All-Wave Superheterodyne.

CLIP-----

E. H. SCOTT RADIO LABORATORIES, Inc.
(Formerly Scott Transformer Co.)
4450 Ravenswood Ave., Dept. SWC-12 Chicago, Ill.
Send me full particulars of the Scott All-Wave Receiver.

Name.....

Street.....

Town..... State.....

The SCOTT ALL-WAVE

15-550 METER SUPERHETERODYNE

HUGO GERNSBACK, Editor

H. WINFIELD SECOR, Managing Editor

CONTENTS

DEC. '31 - JAN. '32

In This Issue: Prominent Short Wave Authors
Code - Binneweg - Tanner - Bryant - Denton - Nason

FEATURES:

Editorial—Wanted: A Short Wave 'Phone League. By Hugo Gernsback	247
How High Is That Balloon? By Capt. James A. Code, Jr., U. S. Signal Corps	248
Plane Can Land in Fog!—Thanks to Short Waves, by Lieut. Myron F. Eddy, U. S. N. (Ret.)	249
The Lincoln All-Wave Super-het, by H. Winfield Secor	250
All-Wave Receiver Using 6.3 Volt "Auto" Tubes, by Beryl B. Bryant	252
Locating Ore Deposits by Ultra Short Waves, by A. Binneweg, Jr.	254
A New S-W Converter of Novel Design, by James Millen, M.E.	256
A Two-Tube Short Wave Receiver that Reaches 12,500 Mile Mark, by Walter C. Doerle	258
A Short Wave Super-Converter That's Different	260
Marvellous Reception by Coupling Long and Short Wave "Super-hets," by Burt H. Taylor, W1KB	261
A New Console Receiver for Short and Broadcast Waves—the "Stewart-Warner"	262
The A. C. Superregenode, by Clifford Denton	264
How Are Short Waves Propagated? By F. Bodigheimer	266
All-Electric, Single-Dial Tuning, Short Wave Super-het, by K. Konig	268
Economic Modulators for Amateur Phone Transmitters	270
How Many Microhenries in that Coil? By James K. Clapp, Engineer, General Radio Co.	272
The Pilot "All-Wave" Receiver	275

SHORT WAVES FOR THE BROADCAST LISTENER:

The Lincoln All-Wave Super-het	250
All-Wave Receiver Using New 6.3 Volt Auto Tubes	252
The New Silver-Marshall S. W. Super-het Converter	260

National Presents New Switch Type S. W. Super-Converter	256
The Workrite S-W Converter	257
Marvellous Reception by Coupling Two Super-hets	261
The Stewart-Warner S. W. and Broadcast Wave Receiver, with "Television Terminals"	262
"When to Listen In." by "Bob" Hertzberg	263
The Pilot All-Wave Receiver	275
Short Wave Stations of the World—Operating "Time Table"	278

SHORT WAVE RECEIVERS:

The Lincoln All-Wave Super-het	250
All-Wave Receiver Using New 6.3 vt. Auto Tubes	252
A New Console Receiver for Short and Broadcast Waves	262
The A. C. Superregenode	264
All-Electric, Single-Dial Tuning, Short Wave Super-het	268
The Pilot "All-Wave" Receiver	275

SHORT WAVE TRANSMITTERS:

Simple Sending Antennas for Amateurs	259
Economic Modulators for Amateur Short Wave Transmitters	270
Checking the Short Wave Transmitter, by H. Harrison	271

MISCELLANEOUS:

A "Trap Circuit" for Short Wave Receivers	259
"When to Listen In"	263
How to Cure "Dead Spots" in Receivers	273
The Propagation of Short Waves, by Robert Meyer	274
The New Tanner Audio System	276
Among the Hams	277
Short Wave Stations of the World	278
Ultra Short Wave Condensers	280
Short Wave Question Box, by R. Wm. Tanner, W8AD	281
How to Use a Wavemeter	282

IN OUR NEXT ISSUE:

Experimenting with Quasi-Optical Waves, by C. H. W. Nason
A Signal Frequency Amplifier for Short Wave Converters, by E. T. Somerset, G2DT
Keying with a "Vacuum Contact" Relay
Building a Simple and Inexpensive "Amateur Band" Receiver
The All-Wave Super-Booster and S. W. Converter, by H. G. Cisin, M.E.

An Economical Short Wave Receiver, by Lewis Ewing, W8ECH
The De-Luxe Amateur Radio Station of Gordon I. Henry
Short Waves at the Berlin Exposition, by Dr. Fritz Noack
Inexpensive 'Phone Transmitters—How to Build Them, by A. R. Haidell

OUR COVER — Illustrates an Extremely Compact and Efficient 3 Tube "All-Wave" Receiver Employing New 6.3 Volt Auto Tubes; for Construction Data, see.....Page 252

SHORT WAVE CRAFT—Bi-monthly. Entered as second class matter May 7, 1930, at the post office at Mount Morris, Illinois, under the act of March 3, 1879. Trademarks and copyrights by permission of H. Gernsback, 98 Park Place, N. Y. C. Text and illustrations of this magazine are copyright and must not be reproduced without permission. SHORT WAVE CRAFT is published on the 15th of every other month. Six numbers per year. Subscription price is \$1.50 a year in the United States and possessions. Canada and foreign countries, \$1.75

a year. Single copies 50c. Address all contributions for publication to Editor, SHORT WAVE CRAFT, 96-98 Park Place, New York, N. Y. Publishers are not responsible for lost manuscripts. Contributions cannot be returned unless authors remit full postage. SHORT WAVE CRAFT is for sale at all principal newsstands in the United States and Canada. European agents: Brentano's, London and Paris. Printed in U. S. A. Make all subscription checks payable to Popular Book Corporation.

London Agent:

HACHETTE & CIE.,
16-17 King William St.,
Charing Cross, W.C.2

Paris Agent::

HACHETTE & CIE.,
111 Rue Reaumur

COPYRIGHT, 1931, BY H. GERNSBACK

Published by POPULAR BOOK CORPORATION

HUGO GERNSBACK, President - H. W. SECOR, Vice-President
EMIL GROSSMAN - Director of Advertising
Chicago Adv. Office - L. F. McCLURE, 737 No. Michigan Blvd.

Publication Office, 404 N. Wesley Avenue, Mount Morris, Ill.
Editorial and General Offices, 96-98 Park Place, New York, N. Y.

Australian Agents:
MCGILL'S AGENCY,
179 Elizabeth St.,
Melbourne

Big Pay Jobs for Trained RADIO Men

5000

Service Men Needed

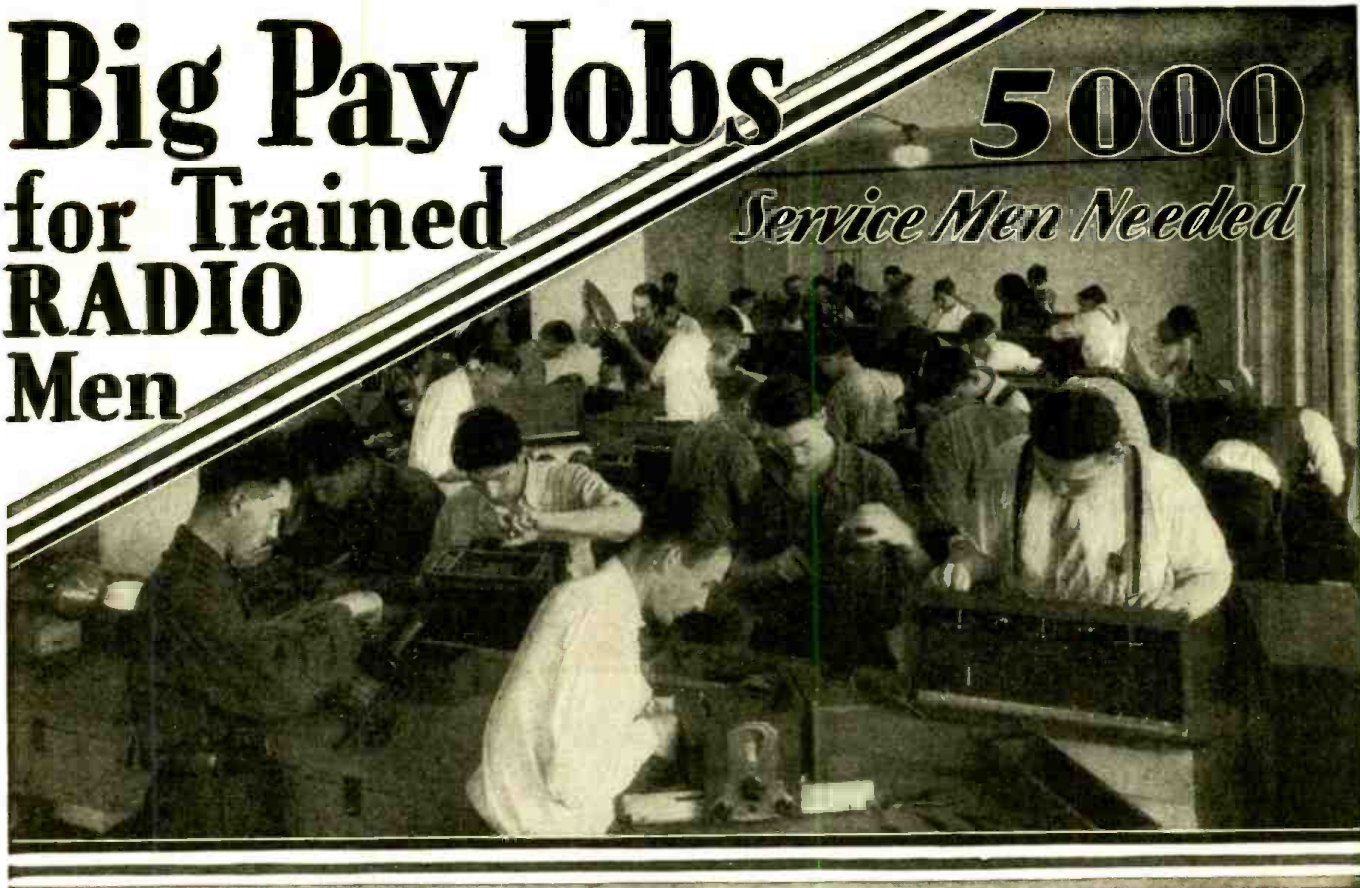

ACTUAL PHOTOGRAPH OF STUDENTS WORKING IN SERVICE DEPT. OF COYNE RADIO SHOPS

LEARN RADIO-TELEVISION TALKING PICTURES AT COYNE

TEN WEEKS of SHOP TRAINING on RADIO EQUIPMENT

Dissatisfied with your job? Not making enough money? Then let me show you how to prepare for a real job and how to make real money, in RADIO—one of the fastest growing, biggest money-making trades on earth.

JOBS LEADING TO BIG PAY

Scores of jobs are open—jobs as Designer, Inspector and Tester—as Radio Salesman and in Service and Installation work—as Operator or Manager of a Broadcasting Station—as Wireless Operator on a Ship or Airplane—with Talking Picture Theatres and Manufacturers of Sound Equipment—with Television Laboratories and Studios—fascinating jobs, offering unlimited opportunities to the Trained Man.

PRACTICAL Shop Training

Come to Chicago and prepare for these jobs the QUICK and PRACTICAL way—BY ACTUAL SHOP WORK on ACTUAL RADIO EQUIPMENT. Some students finish the entire course in 8 weeks. The average time is only 10 weeks. But you can stay as long as you please, at no extra cost to you. No previous experience necessary.

Broadcasting — Television Sound Equipment

In addition to the most modern Radio equipment, we have installed in our Shops a complete model Broadcasting Station, with sound proof Studio and modern Transmitter with 1,000 watt tubes—the Jenkins Television Transmitter with dozens of home-type Television receiving sets—and a complete Talking Picture installation for both "sound on film" and "sound on disk." We have spared no expense in our effort to make your training as COMPLETE and PRACTICAL as possible. Mail the coupon for full particulars!

Free Employment Service TO STUDENTS

After you have finished the course, we will do all we can to help you find the job you want. We employ three men on a full time basis whose sole job is to help our students in finding positions. And should you be a little short of funds, we'll gladly help you in finding part-time work while at school. Some of our students pay a large part of their living expenses in this way. Get all the facts!

COYNE IS 32 YEARS OLD

Coyne has been located right here in Chicago since 1899. Coyne Training is tested—proven by hundreds of successful graduates. You can get all the facts absolutely free. JUST MAIL THE COUPON FOR A FREE COPY OF OUR BIG RADIO AND TELEVISION BOOK.

H. C. Lewis, Pres. **Radio Division** **Founded 1899**
COYNE ELECTRICAL SCHOOL
500 S. Paulina Street Dept. 91-2K Chicago, Illinois

H. C. LEWIS, President
Radio Division, Coyne Electrical School
500 S. Paulina St., Dept. 91-2K, Chicago, Ill.

Send me your Big Free Radio, Television and Talking Picture Book. This does not obligate me in any way.

Name
Address.....
City.....State.....

Something NEW

in Short-Wave Converter Line!

<p>15 to 200 Meters— No Plug-in Coils Used!</p>	<p>Sensitive! Completely AC Operated Without Hum!</p>
--	--

READ RADIO WORLD'S EXTRA-SPECIAL FREE OFFER OF SHORT-WAVE CONVERTER AS SUBSCRIPTION PREMIUM!

RADIO WORLD, now in its tenth year, is the first and only national radio weekly, and publishes the latest, up-to-the-second news of circuits, both of kit types and of 1931-2 commercial receivers, as well as news of happenings in the broadcasting field. Lists of broadcast and short-wave stations are published regularly. You get your information weekly—which means quickly—and you get it accurately, so be sure to become or remain a subscriber for RADIO WORLD.

The regular subscription rates are: \$6 for one year, 52 issues, one each week; \$3 for 6 months, (26 weeks); \$1.50 for three months, (13 weeks); \$1 for 8 weeks; 15c per single copy. Newsdealers everywhere.

Matched impedance output in a short-wave converter is something new, and something extremely valuable, as you are then assured of creating the best conditions for high sensitivity. The converter illustrated tunes from 15 to 200 meters on any tuned radio frequency or regenerative receiver, uses a band selector switch and has rectifier built in, with 16 mfd. of filter capacity!

A Short-Wave Converter with Matched Output!

EVERYBODY interested in radio desires some device that will bring in short waves, but that does not necessarily mean the outlay of any considerable amount of money. In fact, a three-tube AC-operated short-wave converter, such as illustrated, can be built of complete parts obtainable with an order for a subscription for RADIO WORLD.

The two tubes at left constitute the mixer circuit, and about all that is required for short-wave conversion is a good mixer, as the broadcast set with which the converter is worked will take care of the rest, excepting the B voltage which it is preferable to have in the converter. Here the B voltage is obtained from a 237 rectifier, one that serves the purpose abundantly, however, and which will be found to be utterly dependable.

One-Tenth Cent an Hour to Run

For continuation of the economy practiced in other directions, the operating cost will be very low indeed, since the total consumption will be less than 10 watts. Taking 10c per kilowatt hour as the base (which is about as high as is charged anywhere in the United States), the cost of juice would be only one cent for every ten hours of use! This includes A current and B current!

This is accomplished by using the new automotive series tubes, all three tubes being 237's (general purpose). The tube is a good oscillator, a good amplifier (the two statements are really one), and a good modulator, as well as a good rectifier when hooked up as a diode with interconnected plate and grid elements.

The circuit is about as elementary as it possibly could be, and when it comes to short waves it is usually found that where the complexity is least the results are most.

Theory of Operation

Here we avoid using plug-in coils, by having three pairs of binding posts, with leads brought from the ground side to permit shorting out turns of wire when higher frequencies are to be tuned in.

The theory of operation of the converter is that the modulator is tuned to the frequency desired to be received. The oscillator is tuned to a frequency differing from the other by the intermediate frequency. How much is that difference? Well, it depends on what intermediate frequency is used, that is, what frequency your broadcast receiver is tuned to, and that in turn depends on what region affords greatest sensitivity. Usually, in tuned radio frequency sets, the higher frequencies provide the greater sensitivity, which in a sense is unfortunate, because then there must be greater dissimilarity in frequencies between the two tuned circuits.

Due to this peculiar condition, it is advantageous to have the two circuits separately tuned. The illustration shows that such independence of tuning is established.

ALTHOUGH strictest economy has been practiced, it has been done not only without any sacrifice in performance, but in a manner that makes the performance superb. The two separately tuned circuits help out mightily, but besides, there is the special feature of matched impedance at the output.

The converter is to be connected to a broadcast receiver, but it is not known in advance what type of a load is connected in the set's antenna circuit, and even the possessor of the set may not know. But with this converter it makes no difference because a device is included that enables matching of the impedance of the output of the converter to the impedance of the input of the receiver.

Everything Readily Obtainable

The parts are obtainable as stated, including everything except the tubes, and the recipient of this astonishingly generous premium thereupon will have to wire up the converter according to simple directions. When he has finished this small task, which takes about two leisurely and enjoyable hours, he will have a converter of which he may well be proud, and can demonstrate to friends and others how he brings 'em in on short waves to the delight of all concerned.

There are only three connections to make:

- 1—Remove aerial from set and connect it instead to the antenna post of the converter.
- 2—Run an insulated wire lead from the ground post of the converter to the ground post of the set, leaving the ground at the set post, or transferring it to the converter post, as preferred.
- 3—Connect nearer output post (at right) of the converter to the vacated antenna post of the receiver. Adjust the screwdriver type tuning condenser built into the output circuit.

For Tuned Radio Frequency Sets

Sometimes the input to the broadcast set is of a special type and will not transfer the energy from the converter in a manner in any way acceptable. If this is true, and if the broadcast set is a screen grid set, then disconnect grid clip from the cap of the first radio frequency amplifier in the set, and connect cap with a wire to the output post of the converter, closing the circuit between the two posts on the converter, or making no connection, depending on which method gives much better results.

This converter is for any tuned radio frequency set, but not for super-heterodynes. If you have a super, write for further information.

[NOTE: The three 237 tubes can be supplied as a service @ \$3.50 net for the three. No subscription offer attaches to the tubes.]

Send \$12 for two years subscription for RADIO WORLD (104 issues, one each week) and ask that PR-NCV be sent FREE. Shipping weight, 7 lbs. We do not pay transportation.

RADIO WORLD, 145 West 45th Street, New York, N. Y.

SHORT WAVE Specialists!

Also MANUFACTURERS of RECEIVERS and TRANSMITTING APPARATUS

As specialists in the manufacturing of short wave radio apparatus, we have, during the past few years, developed receivers which are used in all parts of the world. These Short Wave Sets have given thousands of fans world-wide reception . . . their prices are extremely low and the materials included in the sets are high-grade and fully guaranteed.

AERO WORLD WIDE—1 TUBE SHORT WAVE RECEIVER



\$6.45

Police Calls, Television Amateur and Commercial Bands. Also your regular Broadcast Band.

Span the World with this Set!

WORLD-WIDE RECEIVER gets 14 to 550 meter stations with surprising clarity. New thrills for you when you listen to London, Paris, Buenos Aires and other far-away stations. Completely assembled in attractive cabinet, with six coils. Equipped with UX socket and suitable for operation with either a UX-200A, UX-201A or UX-112A tube, using a 6-volt "A" battery. The UX199 tube may be used with 1 1/2 volt "C" battery, or two dry cells as an "A" battery; the new type 230 tube requires two dry cells for "A" supply. The "B" power may be 45 to 90 volts.

Head Phones extra \$1.75
Adapter cable with socket for DC sets.95

AERO WORLD WIDE—2 TUBE SHORT WAVE RECEIVER

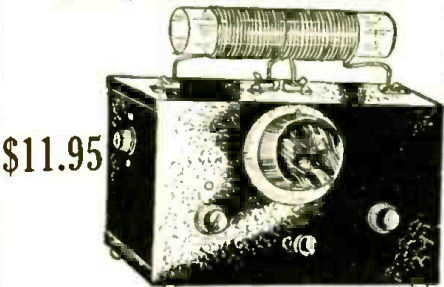

\$11.95

An all around set which gives loudspeaker volume; in metal shield-cabinet. Six coils included; covers wave band from 15 to 550 meters.

AERO C. W. TRANSMITTER

Complete Phone and Transmitter in beautiful cabinet



\$39.50

15 to 30 watts. Including tuned plate, tuned grid oscillator with provision for crystal control. Wired for one or two 1X210 tubes, one or two 250's as modulators, and two stages of speech amplification; 8 coils included. Mounted in walnut cabinet. Price includes Stromberg-Carlson Microphone. Ample space for our A.C. power supply.
Power Supply Unit for 15 to 30 watt Transmitter, \$19.75. Will deliver 150 milliamperes at 600 volts for plate current. Has filament for types 281, 210, 250, 226 and 227 tubes.

NEW AERO MIDGET



\$16.50

Due to the use of the Latest Pentode tube this set is equal in performance to many 8 tube sets.

Using the latest type Pentode and Multi-Mu Tubes. This Midget performs on distance and has tone qualities like a large expensive set. Wonderful selectivity. Full dynamic speaker, full vision dial, beautiful walnut finish cabinet. This is a 5-tube set. Price 60 cycle A.C. **\$16.50**

110 Volt
Price for set of 5 tubes, \$4.50. Available in 110 to 220 Volts, 25 to 60 Cycle AC and DC \$2.50 extra.

AERO SHORT WAVE CONVERTER

15 to 200 Meters

Police Calls, Television Amateur and Commercial Bands.

\$12.50

Convert your AC or DC radio set into a short-wave Super-tereddyne. With this converter on your regular set you will be able to tune in short-wave stations from many different parts of the world. The Aero Converter contains its own filament supply. If voltage can easily be obtained from your regular set, or you may use a single 45-volt B battery. No plug-in coils. Single tuning dial. Very easy to tune. No whistles, or squeals. Uses two UX227 tubes, one as oscillator and one as mixer. Price, AC model, less tubes, ready for operation **\$12.50**

DC model for battery-operated sets, \$11.50. Two matched 1X227 Tubes at 75c each, \$1.50; one 45-volt battery, \$1.45.



AERO PENTODE AUTO RADIO



\$20.00

This is the latest model 6-Tube Aero Pentode Auto Radio. Due to the use of the latest Pentode tubes, this set is equal in performance to many 8 tube receiving sets. The circuit used is one which will be embodied in most of the expensive 1932 model auto radios. The complete set can be clamped on the steering post of your car, or can be operated by remote control from the dashboard. Price of set only **\$20.00**

This set complete with tubes, batteries, dynamic speaker, antenna equipment and noise suppressors, \$39.50.

SHORT WAVE—LOW POWER AERO TRANSMITTER

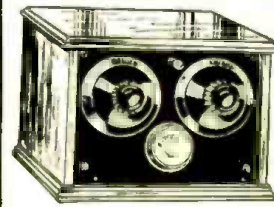

\$14.45

Simple one-tube, low power transmitter with plug-in coils. Ideal for beginners. Can be used for code or phone, also on

broadcast band for set testing, etc. Used with our ABC Power Pack, with 171A or 112A tube as an oscillator and 226 speech amplifier; 245 tube for modulator. To increase power, use transmitter as master oscillator feeding into stage of push-pull R.F. amplification. Transmitter completely assembled in beautiful cabinet, with one set of plug-in coils and plate milliammeter. Instructions included \$14.75
Our ABC Power Supply for this Transmitter... 8.75
Speech Amplifier and Modulator (uses A.C. or battery tubes) 11.95

IMPERIAL CONCERT GRANDE DYNAMIC SPEAKER



6 VOLT D.C. \$5.75
Noted for marvelous rich tone quality. In a beautiful compact case considered one of the best Auto Radio Speakers made.
Imperial D.C. Dynamic Speaker Chassis \$3.75
An ideal speaker for your A.C. set. State capacity of field when ordering.

OTHER RADIO BARGAINS

- B Eliminator, 180 volt bond dry (including a 280 tube) \$6.75
 - Microphone on desk stand, single button 2.75
 - International Microphone, 2 button 3.75
 - Audio Transformer, any ratio75
 - Microphone Transformers, single button95
 - ABC Transformers, 300 volts each side, A.C. filament, 5, 1 1/2 and 2 1/2 volts 1.95
 - Aero Pentode Power Amplifier 11.50
 - Input for low impedance pick-up microphone or radio employs 1-227, 2-247 Pentodes and 1-280 Rectifier. Supplies its own field power. Undistorted power output 5 watts.
 - Aero ABC Power Supply 0.75
 - A complete filament and B power supply for 6-221 or 6-227 tubes, also 6-235 and 2-247 Pentodes. 1.50
 - Filament Transformers, 2 1/2 volt, 10 amperes.75
 - Chokes, 30 Henry, 60 mill.75
 - Mershon Electrolytic Condenser, 8 MFD, 500 volt (Inverted or upright, can be mounted in any type of set)95
 - Temple Condenser, 10 1/10 MFD, 1000 volts, A.C. test, ratings 4, 2, 2, 1, 1, and 1/10 1.95
 - Western Electric Condenser Blocks, 2 MFD, 500 volts45
 - Ward Leonard 18,000-ohm Voltage Dividers, for any type A.C. set, or B Eliminator65
 - Aero Escutcheon Plates, with full vision dial, complete90
 - R.C.A. Radiotron 210 Tubes 2.75
- Tung-Sol Tubes, Guaranteed first grade, 30-day replacement:
- | | | | | | | | |
|-----|--------|------|--------|------|--------|-------|--------|
| 235 | \$1.35 | 221 | \$1.25 | 281 | \$2.35 | 230 | \$0.95 |
| 234 | 1.60 | 245 | .85 | 280 | .75 | 112A | .95 |
| 238 | 1.60 | 271A | .75 | 200A | .75 | 250 | 2.35 |
| 247 | 1.25 | 226 | .60 | 201A | .60 | UX199 | .95 |

OUR TERMS

All prices quoted are net. We require a deposit of at least 20% on C. O. D. shipments. 3% discount if full remittance is sent with order. All shipments are made F. O. B. Chicago. All our merchandise is guaranteed to be as represented.

FREE CATALOG

The Chas. Hoodwin Company

4240 Lincoln Avenue

Dept. L-17

Chicago, Illinois

WORLD'S BEST RADIO BOOKS



ORDER DIRECT FROM THIS PAGE

WE herewith present to the readers of TELEVISION NEWS the most complete collection of recent important radio books. We have, after an exhaustive study, selected these volumes because they represent the foremost radio books of their kind in print today. There is such a great variety that we are sure it will satisfy any taste as well as any requirement that the student of radio might have.

We publish no catalogue and ask you to be kind enough to order direct from this page. Prompt shipments will be made to you direct from the publishers. We merely act as a clearing house for a number of radio book publishers and OUR PRICES ARE AS LOW OR LOWER THAN WILL BE FOUND ANYWHERE. Prompt shipments will be made.

Remit by money order or certified check. If you send cash, be sure to register it. If you wish to get any other radio book, please write us.

EXPERIMENTAL RADIO, by R. B. Ramsey, Professor of Physics, Indiana University. Cloth covers, size 7 1/2 x 5 1/2", 236 pages, 168 illustrations. Price, postpaid **\$2.75**

This book by Professor Ramsey is written in the nature of an experimental radio course and contains 128 experiments. Illustrated and described in a clear and interesting style. The experiments cover such valuable subjects as: A test on a loud speaker; the impedance of coils; construction of a filter, screen grid tube; beat note audio oscillator; etc.

PRINCIPLES OF RADIO COMMUNICATION, by J. H. Morecroft, Prof. of Electrical Engineering, Columbia University. Cloth covers, size 9 1/2 x 6", 988 pages. Profusely illustrated. Price **\$7.50**

A radio classic. Indeed, is Professor Morecroft's very complete text-book which covers such important radio phenomena as: the action in condensers; self and mutual induction in a circuit; phase and phase difference; effect of condensers and coils on wave shape; resonance frequency of coupled circuits; skin effect in coils; antenna resistance; transformers; vacuum tubes; radio frequency alternators; modulation and circuits; amplifiers and filters.

RADIO TRAFFIC MANUAL AND OPERATING REGULATIONS, by H. L. Duncan and C. E. Drew. Flexible covers, size 9 x 6", 186 pages. Price **\$2.00**

This valuable handbook starts off with instructions on how to learn the code in considerable detail, with a list of abbreviations. Then comes operating rules and regulations of the Radiomarine Corporation of America with operators' report forms; followed by the rules of the International Radiograph Convention; the United States Radio Act of 1927; the Ship Act of 1912; etc.

PHOTOCELLS AND THEIR APPLICATION, by V. K. Zworykin, E.E., Ph.D., and E. D. Wilson, Ph.D. Cloth covers, size 5 1/2 x 8", 210 pages, 97 illus. Price **\$2.50**

Photocells today occupy a very important place in radio and talking pictures, as well as other branches of applied science, and these two experts have provided the very latest information as to the action taking place in various types of photocells. The theory on which these different cells operate, including color sensitivity, together with amplifier and scanning discs used in picture as well as television transmission, etc.

PRINCIPLES OF RADIO, by Keith Henney, M.A. Cloth covers, size 8 1/2 x 5 1/2", 478 pages, 306 illustrations. Price **\$3.50**

The author is well known in radio and he has here provided a very complete and clearly written discussion of radio circuits and apparatus, including such important topics as: condensers; transformers; determination of inductance;

vacuum tube action, including Screen Grid and Pentode; wave meters, their calibration and use; modulation; amplifiers; long wave receivers; and different types of rectifiers.

HOW TO PASS U. S. GOVERNMENT RADIO LICENSE EXAMINATIONS, by H. L. Duncan and C. E. Drew. Flexible covers, size 9 1/2 x 7", 170 pages, 92 illustrations, appendix. Price **\$2.00**

The authors are thoroughly conversant with their subject and all of the most important information including hook-ups; types of antennae and receivers with wiring diagrams of both small and large receivers; and transmitters of commercial type, including ship sets are given.

RADIO RECEIVING TUBES, by Meyer and Wostrel. Cloth covers, size 7 1/2 x 5 1/2", 293 pages, 181 illustrations. Price **\$2.50**

No radio student or operator can do without this authoritative book on the radio vacuum tube. The various chapters include construction of vacuum tubes; electrical fundamentals; elementary action taking place in the vacuum tube, with graphs; reactivation of tubes; testing of tubes including determination of amplification factor; plate resistance; grid resistance, etc.

PRACTICAL RADIO—INCLUDING THE TESTING OF RADIO RECEIVING SETS, by James A. Moyer, S.B., A.M., and John F. Wostrel. Cloth covers, size 8 1/2 x 5 1/2", 278 pages, 223 illustrations. Price **\$2.50**

Everyone will find this volume of the utmost practical value as the authors have explained in text and diagrams, for the practically-minded student, such interesting subjects as: telephone receivers and crystal sets; various types of aerials; current sources for vacuum tubes; audio and radio frequency amplification with hookups; loud speakers and how they work; various radio receiving sets with diagrams and just how they work.

PRACTICAL RADIO CONSTRUCTION AND REPAIRING, by J. A. Moyer, S.B., A.M., and J. F. Wostrel. Cloth covers, size 8 1/2 x 5 1/2", 354 pages, 163 illustrations. Price **\$2.50**

This handbook is one that every radio set tester and general student will want to read carefully. These experts have given a very complete description of instruments used to test and repair modern radio sets, together with complete diagrams of many modern receiving sets, with explanations on how to test the radio and audio frequency stages for faults.

ELEMENTS OF RADIO COMMUNICATION, by Professor John H. Morecroft. Cloth covers, size 9 x 6", 270 pages, 170 illustrations. Price... **\$3.00**

Professor Morecroft explains in an authoritative and clear manner such important radio phenomena as current flow in circuits containing capacity and inductance; propagation of radio waves; vacuum tubes as detectors and amplifiers; fading of radio waves and its causes; neutralization; superheterodynes for short waves, etc.; audio frequency amplifiers; how filters work, etc.

RADIO TELEGRAPHY AND TELEPHONY, by R. L. Duncan and C. E. Drew. Cloth covers, size 9 1/2 x 6", 950 pages, 468 illustrations. Price **\$7.50**

This 950 page book forms indeed a most complete treatise on radio facts. The authors treat thoroughly the magnetic circuit; Olm's law; transformers and induction; motor generators and starters; storage batteries; alternating current; capacity and inductance formulae. Vacuum tubes as detectors and amplifiers; ocellographs; radio compass; wavelength measurements and short wave receivers.

RADIO SERVICE MAN'S HANDBOOK WITH ADDENDA DATA SHEETS, Flexible covers, size 9 x 12", 200 pages, 200 illustrations. Price, prepaid **\$1.95**

This remarkable book contains several hundred illustrations with wiring diagrams and charts covering every conceivable subject, including radio sets, tubes, etc. The book is strictly up-to-date and contains the newest practical information which every radio man absolutely must have.

OFFICIAL RADIO SERVICE MANUAL, by Hugo Gernsback and Clyde Pitch. Flexible covers, size 9 x 12", over 1,000 illustrations, 352 pages. Price, prepaid **\$2.98**

Commercial wiring diagrams for all the regularly manufactured receiving sets are included in this manual and no radio service man or student who builds and repairs radio sets can be without this tremendously useful compilation of circuits and their descriptions. This book is worth \$100.00 to anyone who has a use for it. The Manual is indexed so that any commercial receiving circuit can be found instantly. One of the most valuable radio books ever published.

FUNDAMENTALS OF RADIO, by R. B. Ramsey, Professor of Physics, Indiana University. Cloth covers, size 9 1/2 x 6", 372 pages. Illustrated. Price, prepaid **\$3.50**

Dr. Ramsey gives us a very refreshing treatment of the fundamentals of radio, including battery and dynamo action; alternating currents; induction; vacuum tube constants; aerials of different kinds and how they operate; radio frequency instruments and apparatus; audio amplification and receivers in general.

RADIO TROUBLE SHOOTING, by Ennor R. Ulan, E.E. Flexible covers, size 6 x 9", 323 pages, 257 illustrations. Price **\$3.00**

This is a well illustrated and intensely practical handbook for all radio service men and operators, as well as set builders and testers. Some of the practical problems illustrated and discussed are: interference and noise problems—how to locate and remedy them; antenna circuit troubles and their effect on radio; batteries, chargers and eliminators.

DRAKE'S RADIOD CYCLOPEDIA, by H. P. Manly. Cloth covers, size 6 x 9", 1035 pages. Profusely illustrated. Price **\$6.00**

This massive cyclopedia covers radio apparatus—its operation and maintenance, the various subjects being alphabetically arranged. There are 1735 subjects in alphabetical order ranging from A-battery to zero-beat. This volume contains 1110 illustrations, diagrams, etc. There are 414 illustrations and articles on the building and designing of radio sets, alone; 110 articles with 383 illustrations on the methods of repair, service and adjustment of radio sets.

S. GERNSBACK'S RADIO ENCYCLOPEDIA, by S. Gernsback. Stiff leatherette covers, size 9 x 12", 168 pages. Profusely illustrated. Price **\$1.65**

Radio apparatus, inventors and terms are all illustrated and described in this remarkable book which required the efforts of several engineers in its compilation. The subjects are alphabetically arranged and the illustrations are especially fine and clear.

TELEVISION TO-DAY AND TO-MORROW, by S. A. Moseley and H. J. B. Chapple. Cloth covers, size 8 1/2 x 5 1/2", 130 pages, profusely illustrated. Price, prepaid **\$2.50**

This up-to-the-minute work on television describes in detail the apparatus used by Baird. The student will learn all about scanning discs; the best type of motor; reverse defects and how to overcome them; isochronism and synchronism; various ways of synchronizing the receiving discs; photocells and neon tubes; radio receivers for television signals; noctovision.

SOUND PICTURES AND TROUBLE SHOOTER'S MANUAL, by Cameron and Rider. Cloth covers, size 8 1/2 x 5 1/2", 1120 pages, profusely illustrated. Price **\$7.50**

This useful volume will appeal to all radio as well as "talkie" trouble-shooters. The first chapters deal with fundamentals of electrical circuits, including Ohm's law, A.C. and D.C. circuits, rectifiers, amplifiers, mixers and faders; various types of loud speakers and how to arrange them; photocells; electric motors; various types of talkie projectors; also commercial amplifiers with diagrams are given.

RIDING THE AIR WAVES, WITH ERIC PALMER, JR., by himself. Cloth covers, size 7 1/2 x 5 1/2", 328 pages. Price **\$2.00**

Short wave fans cannot miss reading this highly entertaining and informative book which tells the story of youthful Mr. Palmer and his remarkable achievements as an amateur radio. "Around the World with 5 Watts" and many other interesting subjects appear between the covers of this book.

A POPULAR GUIDE TO RADIO by B. Francis Dashiell. Cloth covers, size 5 1/2 x 8 1/2", 286 pages, profusely illustrated. Price, prepaid **\$3.50**

The author starts off with an excellent section on electricity and magnetism; the use of radio aerials and grounds; the fundamental principles of radio; the electron tube and crystal rectifiers—how they work; the principle of radio amplification; radio inductance coils and condensers; fundamental radio receiving circuits; electrical reproduction of sound; the atmosphere and radio phenomena, etc.

RADIO VISION, by C. Francis Jenkins. Cloth covers, size 9 1/2 x 6", 141 pages, profusely illustrated. Price, prepaid **\$1.25**

A beautifully printed and interesting illustrated history of transmission of images by radio; particularly covering the apparatus and successful demonstrations of the Jenkins system. Other apparatus illustrated and discussed are the Braun tube receiver; the R. C. A. Photo-radio apparatus; the A. T. & T. Company system; and the Bell machine.

RADIO MOVIES AND TELEVISION, by C. Francis Jenkins. Cloth covers, size 9 1/2 x 6", 141 pages, profusely illustrated. Price, prepaid **\$2.50**

An absorbing history, handsomely illustrated, of the Jenkins system of transmitting and receiving movies "via radio." One of the chapters gives constructional details and drawings for building your own Radiovisor or machine for making the radio movies visible in your home. Diagrams of amplifiers are given, with some other very valuable information.

Howtoorder

We cannot make C.O.D. shipments. Our prices are net, as shown on this page. You will note that some of the books include postage. Those that do not will be shipped by express collect if you do not wish to include a sufficient amount of postage.

RADIO PUBLICATIONS

245-S GREENWICH STREET
NEW YORK, N. Y.

HUGO GERNSBACK
EDITOR

DEC.-JAN.,
1931-32



H. WINFIELD SECOR
MANAGING EDITOR

VOLUME II
NUMBER 4

Wanted: A Short Wave "Phone" League

By HUGO GERNSBACK

I HAVE before me a number of letters, received during the past few months from short-wave enthusiasts, urging me to organize a Short-Wave 'Phone League.

The letters are all of a similar tenor; most of the writers pointing out that, inasmuch as I was the originator of the first Radio League in the world (*i.e.*, the old *Wireless Association of America*, dating back to 1908), I should take it upon myself now to organize a 'Phone League.

Code Amateurs Not Interested in Phone

It is pointed out by the writers of the letters that most of the 17,000 licensed radio amateurs in the United States are interested only in "CW" and "code" transmission, and that, as a rule, they are not interested in 'phone transmission.

It is also pointed out that the 'phone "hams" have no magazine wherein they can discuss their thoughts and their experiences, and to print a regular "ham" section on radio 'phone matters. The correspondents usually suggest that SHORT WAVE CRAFT would be the ideal magazine to take up the cause of 'phone "hams." Communications such as these have been coming in ever since SHORT WAVE CRAFT was started; and the letters are becoming so numerous lately, that something has to be done about it.

Easy to Organize a League

I, therefore, take this means to ascertain the sentiments of the 'phone amateurs and would-be 'phone amateurs with respect to a new league to be formed. Naturally, if there are enough 'phone amateurs who respond, it will be an easy thing to organize such a league for you. If not, no harm is done.

Of course, the would-be 'phone "ham" who does not know much about the legal regulations is apt to jump to the conclusion that all he has to do, is to rig up a transmitter and go ahead and use 'phone transmission all over the globe. It is not quite as simple as that; because, in the first place, he cannot get a license from the Department of Commerce

unless he can actually transmit code. Even though he need not be an expert, he must be able to read signals with a fair degree of accuracy; otherwise he cannot obtain a license and, for that reason, cannot operate a radio 'phone transmitter. I am making these few remarks merely for those new short-wave fans who have not known about the Department of Commerce regulations.

A Powerful Amateur Aid

If the serious-minded 'phone "hams" are interested, I shall be glad to be instrumental in the foundation of the new league; and I believe a league such as this can, in time, be worked up to not only national, but even international importance. It is certain that, in time to come, the league would attract literally hundreds of thousands of "hams" to it; and enough new inventions would be forthcoming to make the league a most powerful organization in this and every other country.

Are You Interested in Forming a League?

If, therefore, you are interested in the formation of such a league, I suggest that you write to me, giving me your thoughts in the matter, and also fill out the blank printed on page 286 of this issue.

In addition to this (inasmuch as not every 'phone "ham" sees this magazine regularly) it would be an excellent idea for those who have 'phone transmitters to call the attention of this article to others by radio and so broadcast the idea that, if there is sufficient demand, a new 'phone league will soon come into life.

Plenty of Room for 'Phone League

It should be noted that, in all of this, there is no thought of either displacing or hurting C.W. amateurs; because I sincerely believe there is room for both classes in amateur radio. Each has its own sphere and neither one need interfere with the other.

If sufficient answers are received, an announcement of the formation of the league will be made in the next issue of SHORT WAVE CRAFT.

SHORT WAVE CRAFT IS PUBLISHED ON THE 15th OF EVERY OTHER MONTH

THE NEXT ISSUE COMES OUT JANUARY 15th

HOW HIGH IS THAT BALLOON?

MIDGET SHORT WAVE TRANSMITTER *Radio's Answer*

By CAPTAIN JAMES A. CODE, JR.

U. S. Signal Corps.

Super-midget transmitter suspended from weather balloon, radiates signals which have been heard up to eleven miles, on a direction-finding receiver fitted with angle-indicating loop.

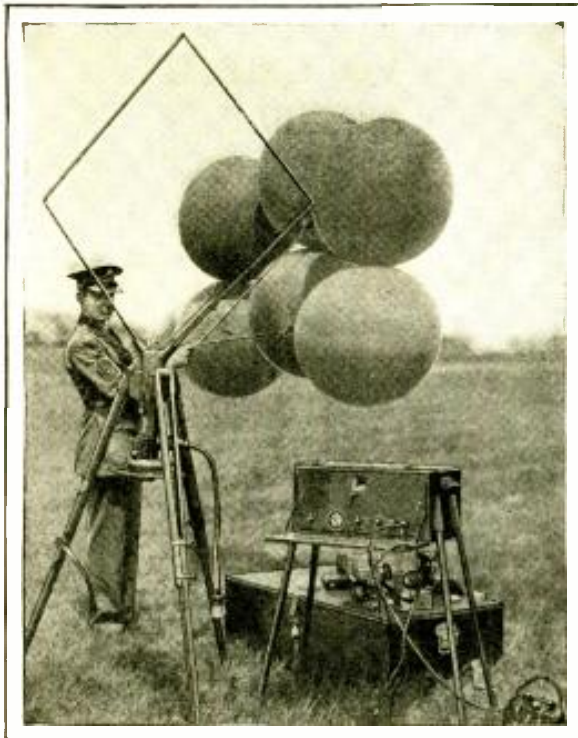

Photo at left shows group of "weather balloons" about to be sent up, together with miniature radio transmitter; receiver at right.

of a light inexpensive transmitter, and the building of a rugged, reliable, portable direction-finding receiver with minimum controls. The transmitter which has been developed approaches quite satisfactorily the requirements. Its weight is but 17½ ozs. It consists of a small flashlight 4½-volt battery, which serves to heat the filament of a '99 tube and, simultaneously, to energize the primary circuit of a buzzer transformer. The turn-ratio of the transformer is approximately 50 to 1; and its iron core is provided with an air gap, to give leakage flux for the operation of the vibrator, which is included in the primary circuit. The secondary voltage is, of course, intermittent at the rate of vibration of the interrupter; and it is part of this voltage which makes the plate positive, once during each cycle of the vibrator, and is thus applied as "B" voltage to the '99 tube.

(Continued on page 292)

UPPER-AIR observations, over terrain which is inaccessible during fogs and inclement weather, are often desirable; though to obtain such meteorological data, which are useful to commerce and industry, is, from the point of view of the fore-caster, extremely difficult. Upper-air meteorological observations at night, or under the conditions mentioned, have been limited to the visual means of attaching some source of light to the meteorological balloon; which is observed through theodolites, and successive readings of azimuth ("bearings") and elevation are obtained by means of the balloon theodolites. Other special methods are used; such as attaching a small bomb with time-fuses to the balloon, and "sound-ranging" for the explosion of the bomb. These methods present difficulties which the Signal Corps has attempted to eliminate by de-



Above—Comparative size of super-midget radio transmitter containing '99 tube, battery, transformer and inductance; weight, 17½ oz. Right—operator listening to balloon radio signals.

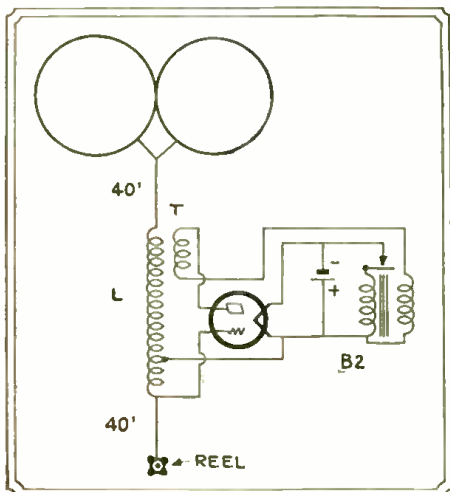

Wiring diagram of the balloon short wave transmitter.

vising a small, compact, radio transmitter which is attached to the balloon and, when released, is tracked by means of radio direction finders.

While the initial work was done in the Signal Corps Laboratories at McCook Field in 1923, it was not until 1931 that Major Wm. R. Blair, of the Signal Corps Laboratories at Fort Monmouth, was able to bring the transmitter and the range finder to its present state of perfection.

Transmitter Weighs But 17½ Ounces

The two problems necessary for the engineer to solve were: the development



Planes Can Land in Fog! Thanks to Short Waves

Airplanes have been repeatedly landed while "flying blind" by the aid of this new short wave "landing beam", which has been developed by Uncle Sam's radio experts. This means that all airports will shortly be made "visible", even in a fog, thanks to short waves.

By LIEUT. MYRON F. EDDY*
U. S. N. Retired

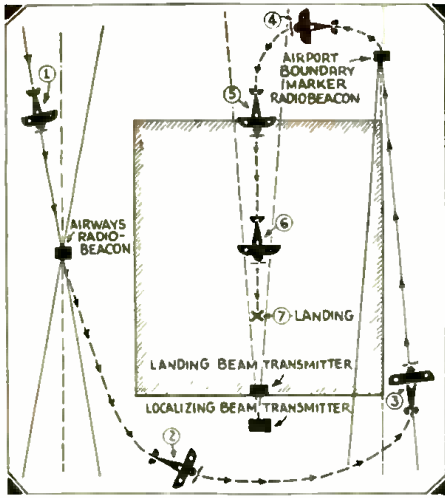

Plan view, showing airport and how landing beam short wave signal is picked up and used to guide plane in landing safely.

FOR the past three years the Bureau of Standards have been working on the short-wave landing beam for airplanes. Now they have it. The beam makes blind landings possible.

The why and wherefore is most interesting. In the first place you realize that the blind flying of planes has been going on for some time. All the U. S. airways have radio-beacons that a pilot can follow from one airport to another, but suppose that he can't see an airport—how is he to land? The short-wave landing beam is the answer. And here is how it works.

The regular airways radio beacon transmitter is located at one side of the airport—not ON the airport. There is also another (marker) beacon, projecting a beam a short distance along the other side of the airport. But the beam transmitter is put right on the airport—right at the end of the landing runway. The pilot follows the airways beacon to the airport where he wishes to land. He knows when he passes over this beacon, because its signals change. Therefore, upon passing the beacon, the pilot turns sharp left to the marker beam, straightens out on it, turns sharp left again and so hits the landing beam. He then turns left once more and follows the beam to a landing. It is as simple as "no right turns" and "one-way traffic"—sometimes simpler!

The value of this system is obvious. It is literally a "life-saver". The landing beam may be set at the airport in the direction of prevailing winds or any other safe landing direction. It may be made steep, for a short approach, as in mountainous localities, or more gradual when a longer approach is desired. It can be picked up at any altitude between 500 and 5,000 feet. No manipulation on the part of the pilot is required since the tuning is fixed. He merely switches in his "landing-beam" receiver at the proper time. This receiver is visual and is mounted on the flight instrument board.

If he keeps the needle on this instrument in the middle by controlling the

plane's elevators, he will come in at a normal landing glide and level off without ever seeing the field. His altimeter will tell him when to cut the throttle completely; although he could hit it partly on and do nothing worse than bounce.

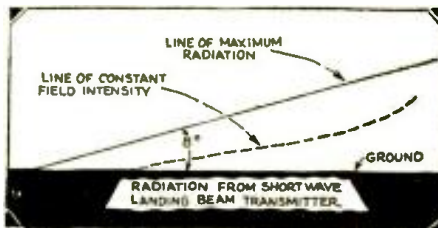

No matter what altitude the plane has when entering the zone of the Landing Beam, the "Landing Indicator" will immediately show whether the plane should commence gliding by reading "Too High" or "Too Low".

Landing Beam Operates on 3 Meters

So much for the system; now about the apparatus. Remember that there must be control, or guidance, over three dimensions. For this reason a beam (called a "localizing beam") must be directed along the runway to form a lane, which will keep the pilot from swerving off the runway to right or left, while gliding down the landing beam. Also, the landing beam itself, although projected as a straight line (tangent to the horizontal runway) must guide the plane down a curved path, which becomes flatter and flatter near the ground end. This path is actually the line of equal intensity and is always below the axis of the projected beam.

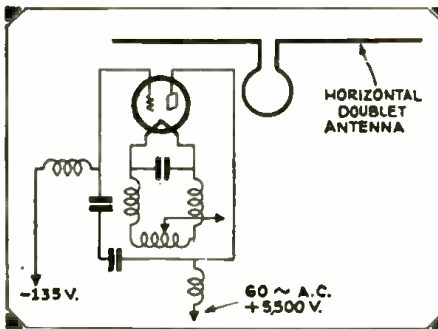

Oscillator circuit of Landing Beam Transmitter.

The landing-beam transmitter operates on about 3 meters. A directive antenna system is, of course, required; this consists of a number of short doublet horizontal antennas, which run perpendicular to the main supporting structure, which in itself is not high enough to be a flight obstruction. This whole outfit can be tilted and locked into position to give

(Continued on page 288)

Simplified dials used to indicate landing conditions to pilot in plane; how close he is to the ground and if he is "off" or "on" the course.

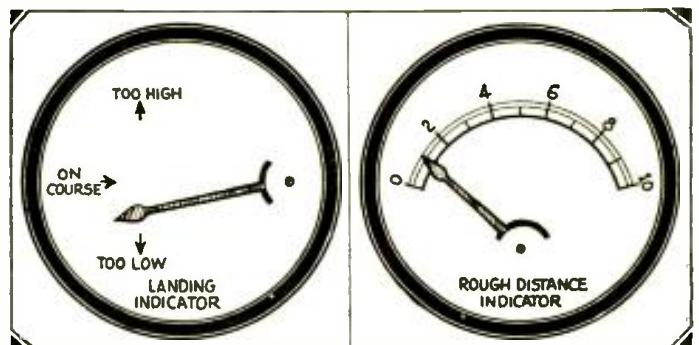

* AeronautTech Institute.

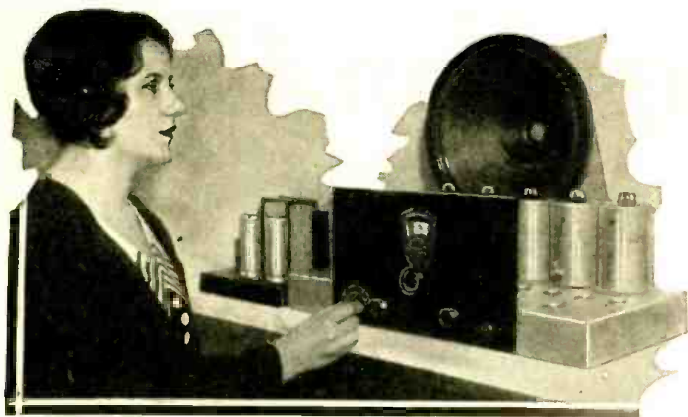

The young lady here shown has her hand on the special knob controlling the wave-band "change-switch", a new feature of the Lincoln "All-Wave" Super-het.

The LINCOLN ALL-WAVE SUPER-HET

By H. WINFIELD SECOR

The new Lincoln De-Luxe combination short and long wave receiver here illustrated, tunes in all waves from 10 to 550 meters. Plug-in-coils are eliminated by a cleverly engineered switching scheme. A super-heterodyne circuit is used, providing sharp selectivity and powerful volume.

WHAT! Another "all-wave" Super-Het? So it seems, but as the old adage has it—"The proof of the pudding is in the eating thereof," and agreeable surprises came fast, one after another, when the new Lincoln All-Wave Super-Het, known as their "De Luxe 32 Model," was lugged home and tested out. In the first place, the Lincoln circuit is of very excellent fundamental design. The intermediate amplifier stages being individually tuned, this operation being a simple one performed but once when the set is first placed into operation. The person operating the set merely adjusts the five midget condenser knobs placed on the tops of the shield cans covering the intermediate amplifier transformers, until a weak signal is heard with maximum strength on the loud speaker.

Tuning In Short Waves a Cinch!

Whether the purchaser of a Lincoln new All-Wave Super is interested particularly in short-wave reception, or only listens in occasionally on short waves, this cleverly designed and highly efficient receiver, will appeal irresistibly. Tuning in short waves is a "cinch" with the new Lincoln—a simple twist of the wrist on the band-selector switch puts immediately at your service the following wavelength ranges: 15-30; 30-50; 50-100; 100-200; and finally the broadcast range of 200-550 meters.

Aside from the excellent design and workmanship of the intermediate transformers, which are wound on bakelite tubes with ample spacing between the coils and the shields, the short-wave inductances are wound very accurately on threaded bakelite tubing. The short-wave coils are mounted in a group inside a shield can placed just behind the panel, at the left of the set, as the illustrations show.

High and Low Power Switch

The double tuning-condenser unit was specially selected for this set, to be of the proper capacity and plate spacing to work equally as well on the short waves

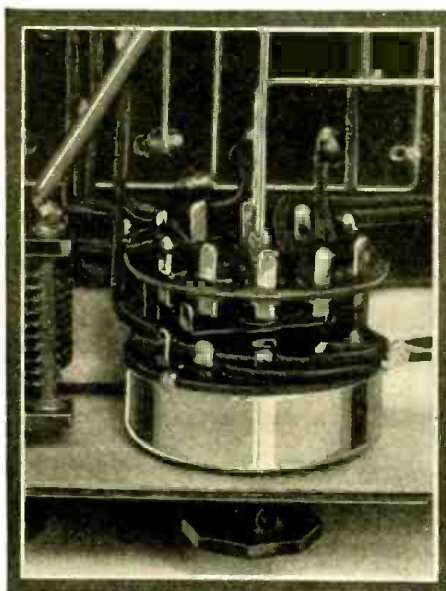

Above — "Close-up" of wave-band "change switch", showing short leads from various coils mounted directly over switch.

Right — Close-up of "short" and "broadcast" wave coils, with shield removed.

as on the broadcast waves. The condenser is fitted with ball bearings. The small knob just to the right of the main tuning knob is a trimmer condenser; the knob to the right of the main dial is the volume control and switch. The small

switch at the right of the front panel provides "high" or "low" power, which obviates *blasting* from the local stations (which, you may be sure, come romping in like a "ton of bricks" on this powerful receiver, with its four "high-gain" stages of shield-grid intermediate amplification).

Powerful Output Stage

In the output audio amplifier stage, two '45's are employed. These tubes were selected as the very best from the viewpoint of powerful volume and exquisite tone quality for this particular receiver, in preference to the use of pentodes.

Besides the powerful amplification due to the very careful design of the inductances, for both short- and long-wave tuning, it was soon demonstrated after bringing in many *broadcast* and *short wave* stations, both from overseas and various parts of this country, that even better than 10-kc. selectivity had been

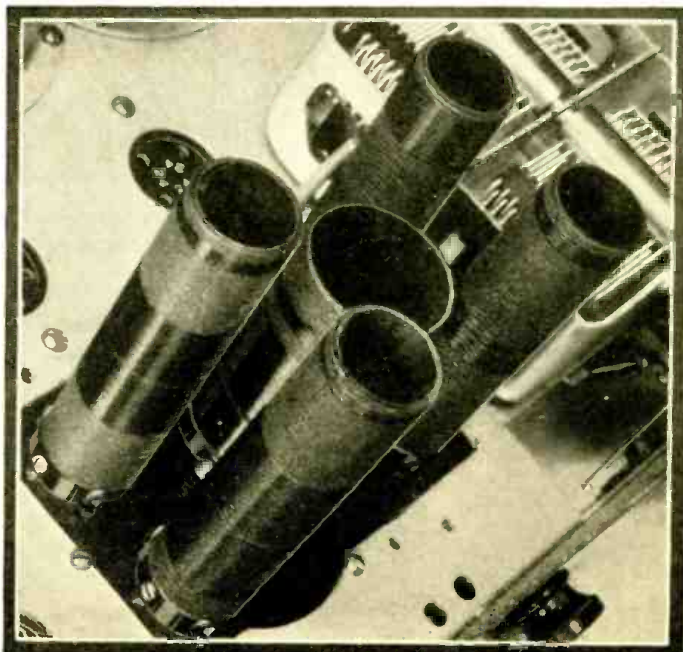

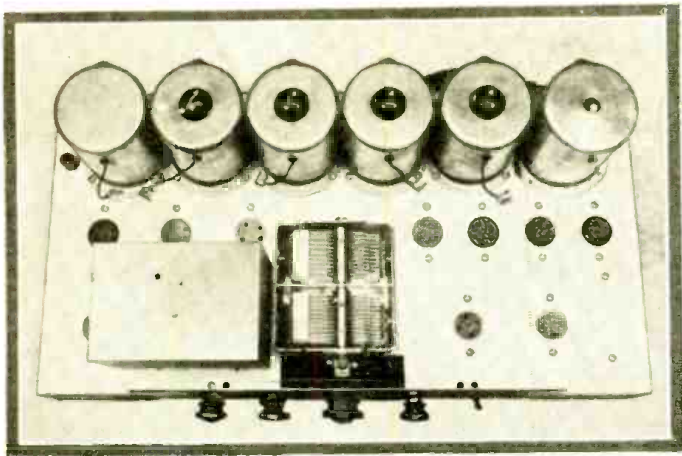

Top view of new Lincoln "All-Wave" super-het.

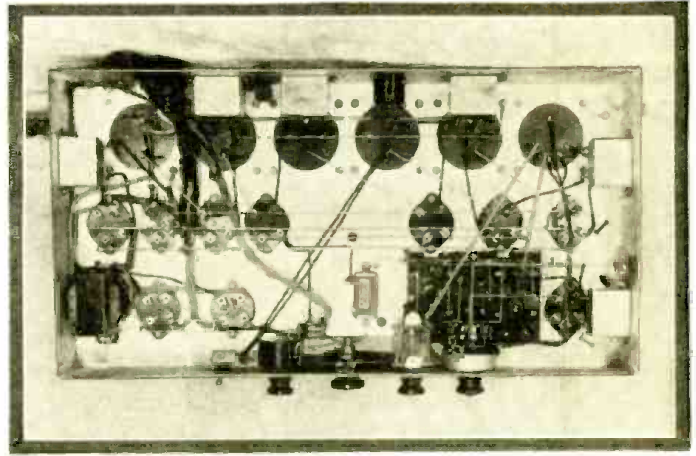

Bottom view—showing simplicity of wiring.

attained by the engineers behind this receiver.

Each Receiver Individually Tested

Furthermore, each receiver is actually tested on distant signals, before the customer ever receives it. One feature which many sets claim to have, but which the Lincoln receiver really demonstrates, is that it actually can produce loud-speaker volume on relatively weak signals. This means that every amplifier stage in the set is working at the "peak" of efficiency.

The Lincoln De Luxe receiver is an extremely high-powered and selective equipment, using the high amplification of six screen-grid tubes. The chassis is very carefully constructed, employing strictly laboratory methods. The position of every wire is carefully figured out to eliminate feed backs and allow high amplification.

Connecting Chassis, Power Unit and Speaker

Cables leading from chassis to power equipment are of different colored wire. Labels on the power equipment clearly indicate where connections should be made. Connections from speaker are indicated on power equipment for energizing the field of the speaker.

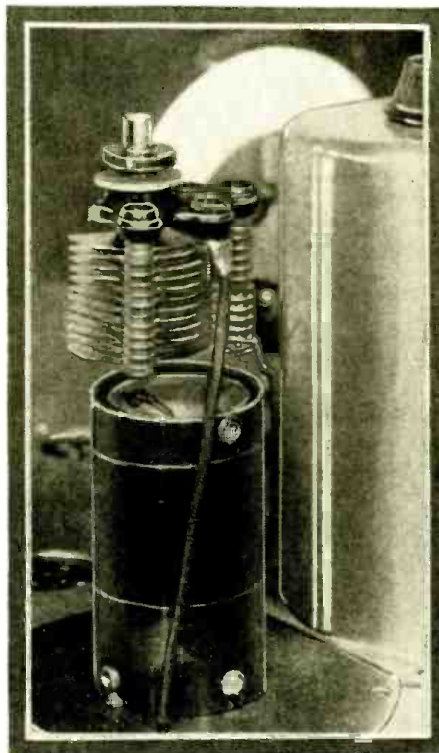

One of the I.F. transformers and 100-mmf. tuning condensers.

The length of antenna depends on local absorption. Ten feet of antenna in one locality will equal a 50-ft. antenna in another. As a general thing, buildings of steel construction require a longer antenna to compensate for loss of absorption in steel, state the Lincoln experts. Antennas from 15 to 100 feet will work satisfactorily.

Operation Hints

First you connect A.C. line to wall socket; turn right-hand control knob until switch is turned on, and see if all heaters are operating.

See that all adjusting knobs on top of I.F. (intermediate amplifier) cans point to marks on top of can. Turn volume control (right hand knob) about half-way on and tune in a station with main dial (center knob), adjusting trimmer (second knob from left) to loudest signal. Then reduce your volume control to a weak signal and carefully go over all of the adjustments on top of the transformers, peaking each one at the loudest point. Next, tune in a distant signal and go over the operation again. Once this adjustment is done, no further attention need be paid to it. Adjustments of the I.F. transformer should be made with the *low-high power switch in high power position.*

(Continued on page 284)

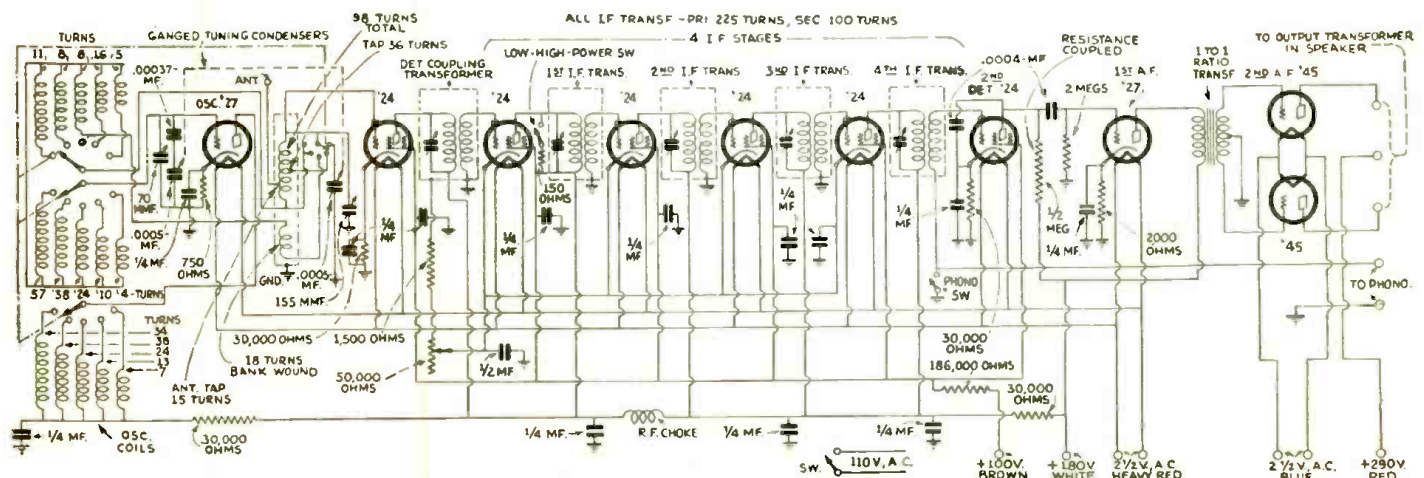

Complete wiring diagram of the new Lincoln De-Luxe "All-Wave" super-het, which tunes from 15 to 550 meters at a single "twist of the wrist". The various coils used for tuning in the different wavelengths and their connections to the "ganged" control switch, are shown at the extreme left of the diagram.

New ALL-WAVE

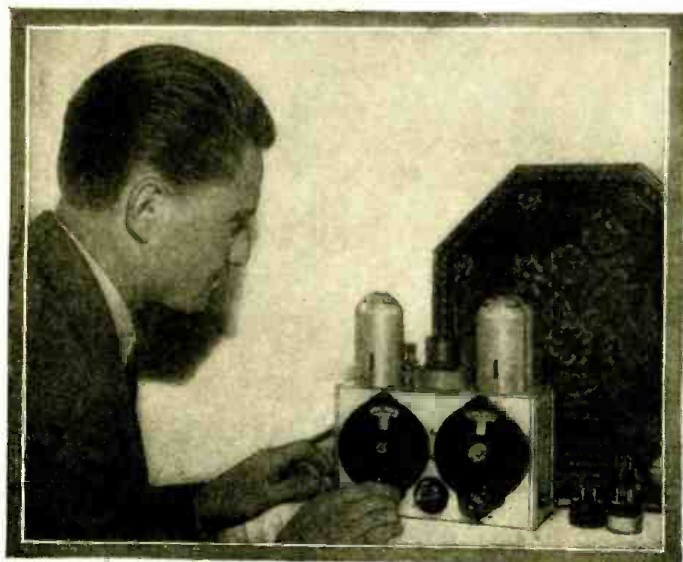

The "All-Wave" receiver, using three "auto" tubes, as tested by the editors.

Many readers have requested that we publish a circuit and describe a receiver using the new 6.3 volt automobile tubes. We aim to give our readers whatever they want, whenever possible, so here is a special receiving set which was built and tested by Mr. Bryant, formerly director of Radio News' Laboratory. Loud speaker reception is obtained with but three tubes, one of which is a pentode. This receiver operates with smooth control of the regeneration, as actual tests demonstrated.

A FEW years ago, when short-wave reception above 2000 kilocycles was given its impetus, and the A.C. operated broadcast receiver was in its early stages of development, engineers dreamed of an A.C. operated short-wave receiver. Short-wave receivers with '01A or '99 battery-operated tubes were then the thing of the day.

Soon, progressive engineers and short-wave operators were employing a single-tube regenerative short-wave receiver, followed by an A.C. operated power amplifier. During this time the writer was conducting experiments leading to the design of a satisfactory A.C. operated short-wave receiver. The preliminary design consisted of a '27 regenerative detector, and a '27 first audio stage, followed by '71 tubes in push pull. Needless to say, the hum level on frequencies above 3000 kilocycles was extremely high. To reduce the hum level it was necessary to change to '27 tubes for the push pull stage, which was later accepted as standard practice. This receiver was the first complete A.C. operated system to be described in public print, and was made possible through the collaboration of Mr. H. G. Cisin, M.E., of the Allied Engineering Institute.

After the introduction and adaptation of the '24 tube into short-wave receivers as a radio-frequency amplifier, no great progress was made in the design of the receivers other than natural refinement. The writer soon learned of, and had the opportunity to operate, a special short-wave transatlantic superheterodyne receiver developed by the Bell Telephone engineers. This receiver did not employ the '27 and the '24 tubes, as might be expected, but used tubes of the '99 type; their filaments being supplied with rectified and filtered A.C. This method was far more satisfactory than the use of the heater type tubes; although the public had accepted the latter as the ultimate tubes for use in short-wave receivers. Many attempts were made to use the heater tubes with rectified and filtered A.C.; but the apparatus required to de-

liver high amperage at low voltage was unsatisfactory. It is recognized, however, that slight hum modulation caused no difficulty in the reading of continuous-wave signals.

Thus it was, that the writer recognized the usefulness of the automobile tubes for short-wave work, when the first experimental designs were submitted to manufacturers prior to their introduction to the public. Because of other, more pressing duties the writer was unable to conduct any tests along these lines until recently; when the editors of SHORT WAVE CRAFT asked him to design a standard circuit around these tubes, for their readers.

ceiver is designed for appearance, low cost, simplicity of construction, and greatest efficiency for the tubes employed in its circuit. The only additional apparatus required is the necessary power supply and a sensitive magnetic or dynamic speaker of 15,000 ohms impedance to work out of the pentode power stage. Any speaker may be used providing the impedances are matched through the use of special transformer. Specially-designed high impedance speakers may be had from any of the major speaker manufacturers.

Construction

The aluminum box is first prepared. This is of the type assembled from sheet

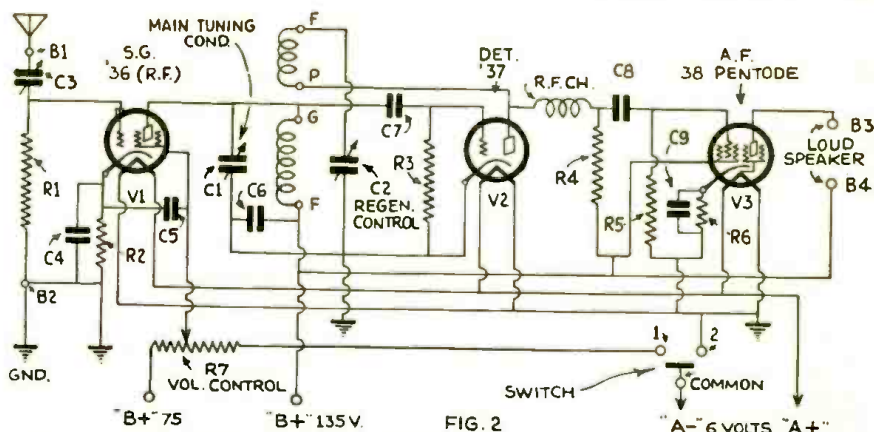

Complete wiring diagrams of the "All-Wave" receiver, which employs three of the latest type, highly efficient tubes, the famous 6.3 volt "automobile" tubes.

The receiver to be described in the following paragraphs has a single stage of radio-frequency amplification, with untuned antenna, and tuned-impedance coupled to a regenerative detector. This is followed by a single stage of audio-frequency amplification, in which the new '38 pentode output tube is used. Using a standard broadcast antenna, the writer was able to receive a number of short-wave phone stations on a loud speaker with room volume. Needless to say, the volume is determined by the antenna power of the sending station. The re-

ceiver is designed for appearance, low cost, simplicity of construction, and greatest efficiency for the tubes employed in its circuit. The only additional apparatus required is the necessary power supply and a sensitive magnetic or dynamic speaker of 15,000 ohms impedance to work out of the pentode power stage. Any speaker may be used providing the impedances are matched through the use of special transformer. Specially-designed high impedance speakers may be had from any of the major speaker manufacturers.

RECEIVER USING AUTO TUBES

By BERYL B. BRYANT

losses due to eddy-current absorption. After the panel has been prepared, the sockets should be mounted in their proper positions with the bases of the tube shields; after which the panel is temporarily laid aside.

The front panel is next laid out and drilled, in accordance with Fig. 1B, for the mounting of the tuning C1 and regeneration C2 condensers; with the volume control R7 placed in the lower center. The holes for the mounting of the vernier dials should be drilled at the same time. The two condensers, with their respective dials, are mounted, and then the volume control.

The rear panel is next drilled for the output binding posts B3 and B4, or, if desired, these may be mounted on the top panel behind the shield can that houses the tuning coil. Needless to say, these binding posts must be insulated from the metal.

The right side panel is next drilled in the lower left corner, as shown in Fig. 1C, for the filament switch, and the switch mounted. Notice that this is a two-pole single-throw switch, serving to break the volume control circuit as well as the filament circuit, in order to conserve the batteries.

(Continued on page 288)

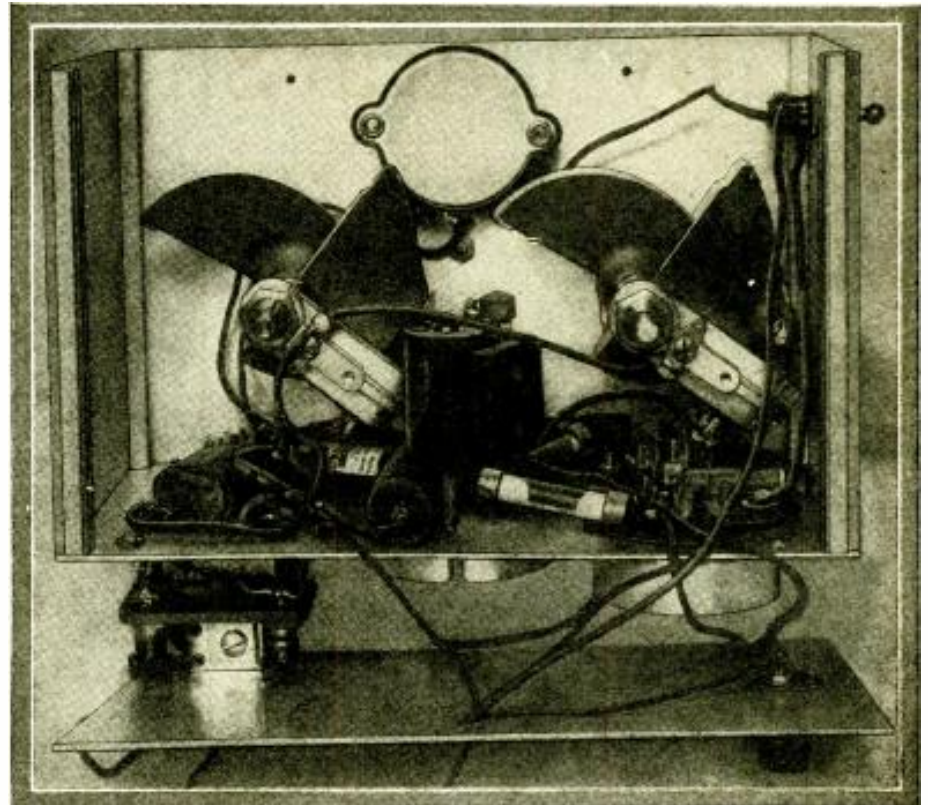

Interior view of the "All-Wave" receiver, which possesses very smooth regeneration control.

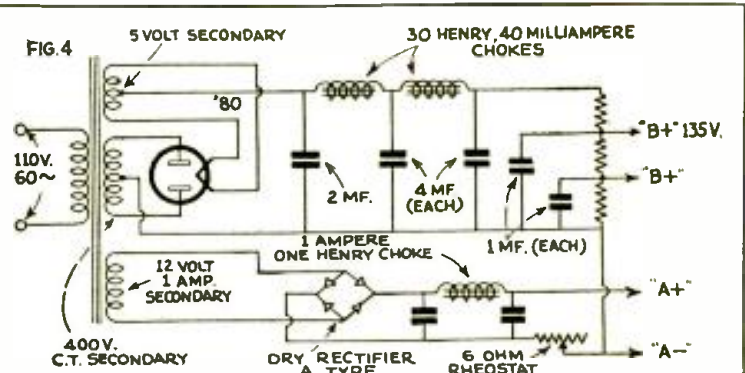
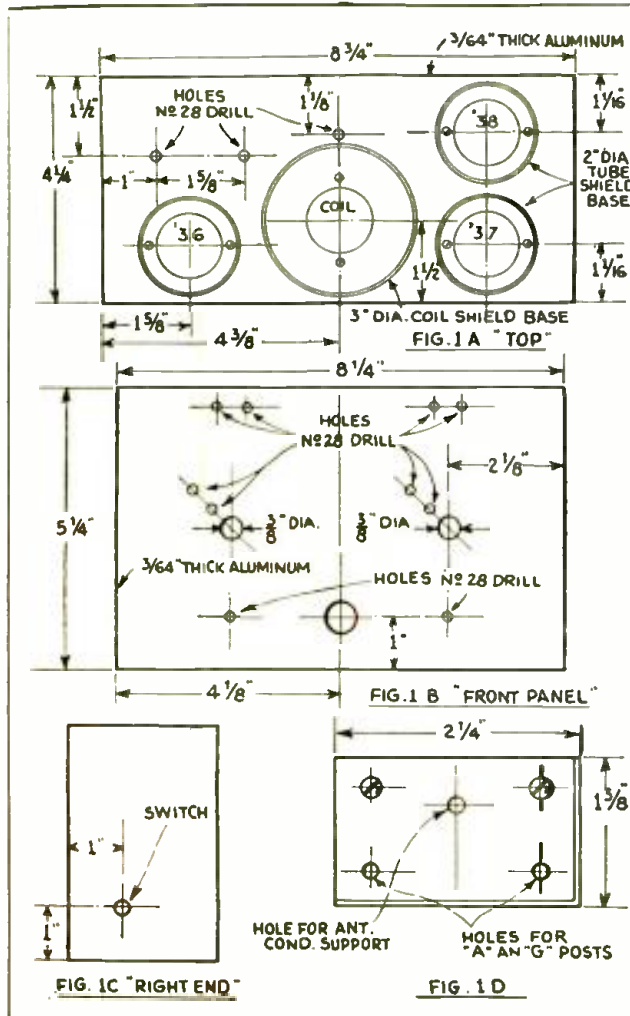

Above—Hook-up of "A" and "B" supply, which some may wish to use with the "All-Wave" receiver here described. Left—Drilling plan and dimensions of aluminum shield cabinet. Below—Data for winding various tube base coils.

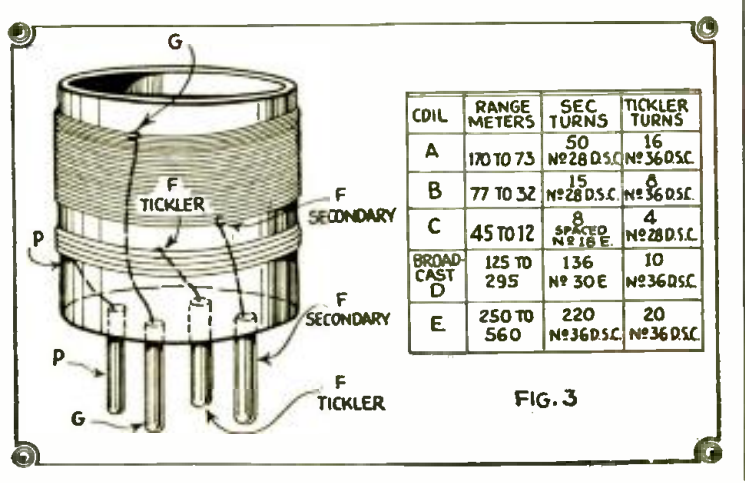

Locating ORE DEPOSITS By Ultra Short Waves

By A. Binneweg, Jr.*

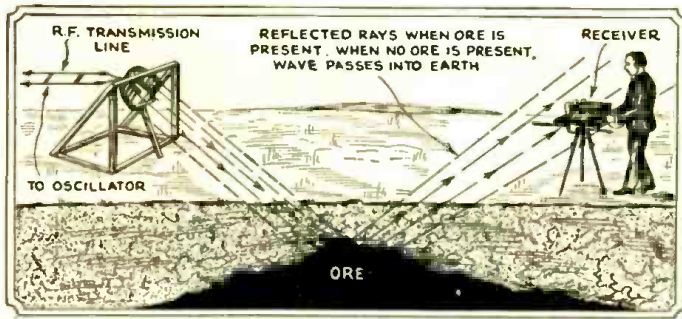

Here we see how ultra short waves are reflected by a metallic ore deposit and this fact indicated by the reception of signals in the receiver.

What is more interesting than the possibility of locating ore deposits by some electrical means? As Mr. Binneweg points out in the accompanying article, there are excellent possibilities of applying very short waves to this problem. The author describes how to build an ultra short wave transmitter and also a receiver, together with suitable focusing reflectors for locating ore or other metallic masses

CONSIDERABLE interest has been shown lately in radio apparatus for electrical prospecting. Those interested in this kind of work are, almost without exception, non-technical men who desire to try their luck at prospecting. It is not necessary to be technically trained in radio in order to conduct an experiment with electrical prospecting apparatus. Truly, this is an age of specialization in which the knowledge in one field is often of considerable value in another.

The writer has specialized for many years in the design of ultra-short-wave transmitting and receiving apparatus, equipment of special interest to those who wish to try this modern method of prospecting. (An article on this subject by Mr. J. I. Heller appeared in the June issue of *Radio-Craft*.) However, there are many improvements which can be made in electrical prospecting apparatus to make it of more practical use to the non-technical reader. Improvements in such apparatus will be considered in this article.

The reader is advised not to attempt the construction of such ultra-short-wave equipment without first experimenting at home. It is not an easy matter to develop apparatus which can be immediately used in the field without some tests, of course.

It is suggested that the reader first try experimenting with apparatus of this kind, employing a tube of either the '45 or the '10 type. These tubes will give sufficient power so that the results obtained are more easy to apprehend. The filament of the tube used can then be operated directly from the light socket, thus saving batteries. The circuit of such an arrangement is shown in Fig. 1. For test work a key is convenient; be sure to make the leads connecting to both the plate and grid of the tube as short as possible, for otherwise it may be difficult to make the tube oscillate at wave-

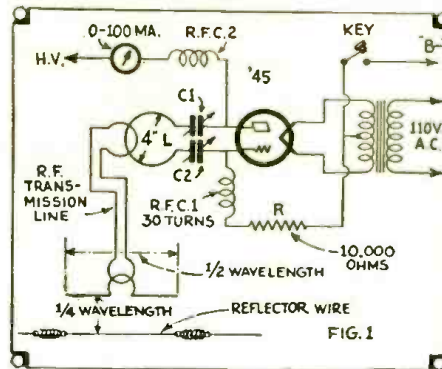

Ultra short wave transmitter and arrangement of antenna with reflector.

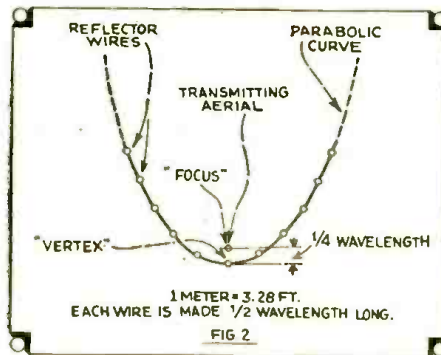

How to arrange the parabolic reflector wires and aerial.

lengths as low as 1½ meters. Condensers C1 and C2 in Fig. 1 may be 30 mmf. midgets.

The coil, L, consists of a loop of copper tubing 4 inches in diameter. The use of tubing is due, not so much to heavy currents to be carried, as to the fact that it is desired to maintain the inductance at a rigid value. The choke coil, RFC1, consists of 30 turns, spaced about ½-inch between turns, on a piece of dowel ½-inch in diameter. The grid-leak, R, is of the heavy-duty type and has a value of 10,000 ohms. The other choke, RFC2,

may be made the same as RFC1. For tubes having higher power, such as the type '45, a 0-100-scale milliammeter may be necessary. For smaller tubes a 0-10-scale instrument will be satisfactory. If the smaller type is available, it can be shunted with a resistance of the proper value for the larger tubes. If a filament center-tap is not available on the secondary of the filament transformer, shunt a resistance of about 200 ohms across the secondary and run the center-tap lead to the center tap of this resistance.

Another advantage of high power is that a radio-frequency transmission line of considerable length can be used; and still sufficient power will be obtained at its far end for coupling into the antenna. The antenna wire is made ½ wavelength long and has at its center a small half-turn loop for coupling to the R.F. transmission line, which has a similar loop at each of its ends. Such a transmission line consists of only a pair of parallel wires, spaced any convenient distance apart, such as one or two inches. The

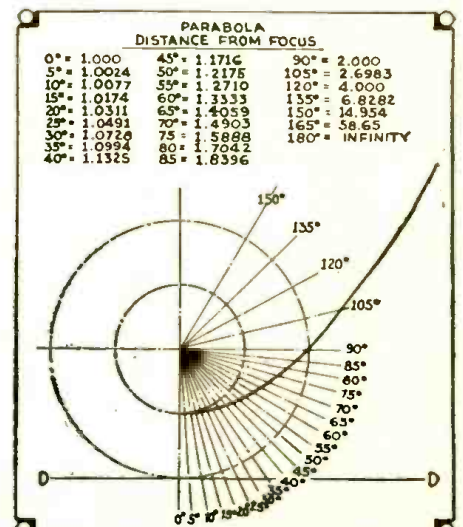

Data for laying out parabolic reflector.

* Engineer, Delft Radio Co.

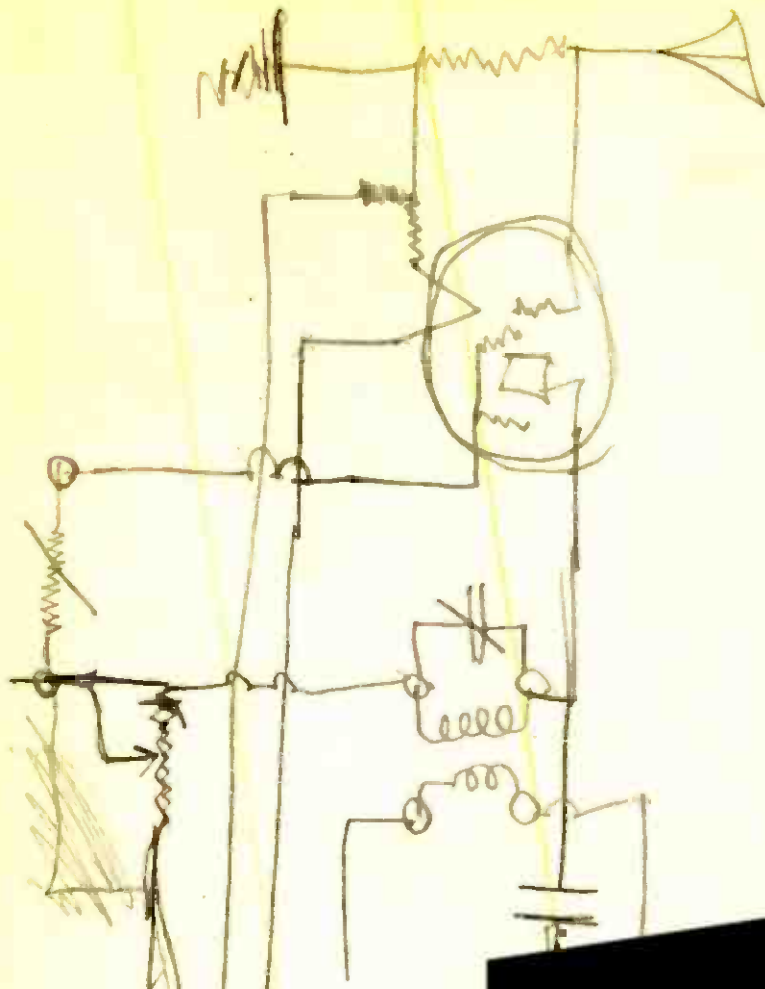

MEMORANDA

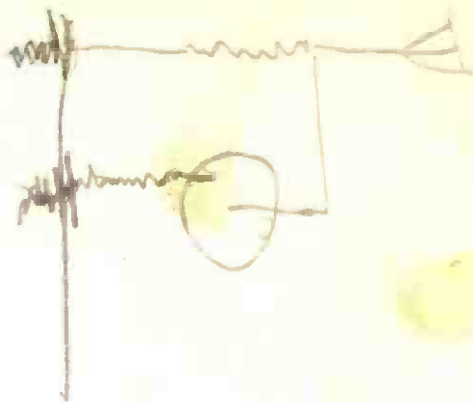

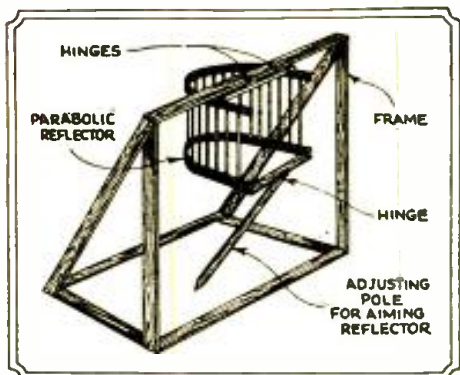

Frame for supporting parabolic short wave reflector and stick for adjusting it to different angles.

wire used in the transmission line can be any convenient size, such as No. 18, or so. By using an R.F. transmission line the transmitting apparatus can be left in some convenient point and the neighboring territory easily explored, without carrying all the apparatus along.

It is important to make the proper choice of tubes for operation at very high frequencies. Some tubes are not very good for this purpose, and perhaps will not oscillate at all. The reason is that the losses in the stem of the tube become quite high, and the oscillator can not supply them. This is shown clearly in Fig. 4. There is a certain value of capacity, between the leads in the stem, which is of considerable importance when the frequency becomes very high. The glass in the stem itself functions as the dielectric of the condenser, and the loss in solid dielectrics is relatively enormous at ultra-short wavelengths. If a plate voltage of about 400 volts is applied on ordinary transmitting tubes at these wavelengths, the dielectric loss is so great that excessive heating results. This heating lowers the dielectric strength of the glass greatly and the plate voltage is able to spark through the glass in the stem, completely damaging the tube. For this reason, it is advisable to use much lower voltages than normally employed in such tubes.

In oscillators, such as shown in Fig. 1, it is sometimes necessary to use small chokes in the filament leads. Such chokes, however, may not be necessary and are not shown in Fig. 1. However, if such

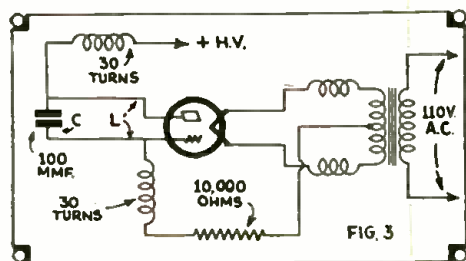
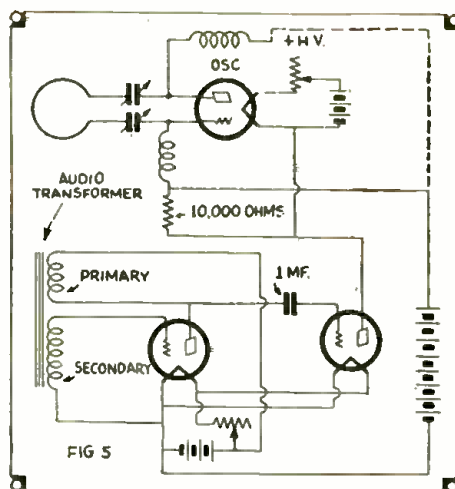

Fig. 3, above, shows the essential connections for a 1/4-meter oscillator.

should be necessary, two chokes having the dimensions of RFC1 and RFC2 can be connected in the two filament leads to the tube. Such chokes must be con-

structed, however, of a wire having sufficient current-carrying capacity so that the filament voltage will not be reduced too much. The proper filament voltage is absolutely necessary for satisfactory operation at these frequencies. Although at low frequencies a tube may oscillate with a very small plate voltage, higher plate voltages are necessary at the higher frequencies.

When testing, study the operation of reflectors. For use in the field, start in with a simple reflector like that shown connected to the end of the R.F. transmission line shown in Fig. 1. Of course, if no transmission line is used, the antenna is directly connected to the inductance, L. A simple reflector consists of the antenna itself and a single wire spaced from it, by one-quarter of a wavelength. Such a reflector wire gives a signal in the direction from the reflector wire through the antenna, of twice the value obtained when the antenna wire alone is used.



Hook-up showing how to connect an audio frequency oscillator into the grid circuit of the short wave transmitter.

Fig. 2 contains some essential data for the construction of a complete parabolic reflector. The distance between the antenna wire and the vertex wire of the reflector should be a quarter-wavelength. The transmitting aerial itself (or the receiving aerial, if the reflector is used for reception) is mounted at the focus of the parabola. The balance of the wires in the reflector are mounted along the parabolic curve having the aerial at its focus. The greater the number of wires used on the parabolic curve, the sharper will be the beam transmitted. If such a reflector is used for reception, the gain will be greater with a greater number of wires. If the number of wires in the reflector is increased, the size of the aerial must be reduced slightly because of the loading effect of the reflector wire.

The beam will also be sharper as the sides of the reflector are extended as shown by the dotted lines in Fig. 2. In determining the correct distance from focus to vertex, divide the operating wavelength by four; this gives the correct distance to space in meters; if this value is changed to feet, one can easily

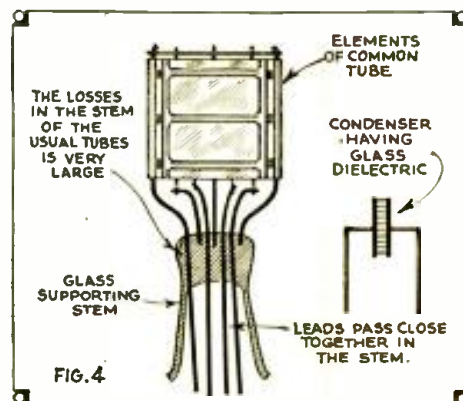

Diagram showing parts of vacuum tube wherein losses are noticeable at high frequencies.

measure it with a common yardstick. The length of the antenna itself will be somewhat shorter than the lengths of the reflector wires, because of the coupling coil at its center, which loads it.

Prospecting Apparatus of the Future

The writer sees absolutely no reason why the radio prospecting apparatus of the immediate future will not be in a greatly simplified form. The apparatus now employed operates at wavelengths close to 1.6 meters. However, at even this frequency the size of the aerial and reflector systems is yet rather cumbersome. By employing a wavelength such as 3/4-meter, the size of this equipment could be radically reduced and even a gain in efficiency obtained. The reflectors would be greatly reduced in dimensions and the sides of the reflector considerably extended to obtain much greater selectivity. This would result in less interference with other services and, at the same time, extraneous waves and unsatisfactory reflections would be to a great extent eliminated.

Another outstanding advantage is that an amateur band of frequencies exists at 3/4 meter. This allows any one with an amateur transmitting license to construct and test such apparatus. At present, a special license is required for transmitting in wavelengths other than the amateur bands. The reader is, perhaps, familiar with the fact that a government license is required for radio

(Continued on page 286)

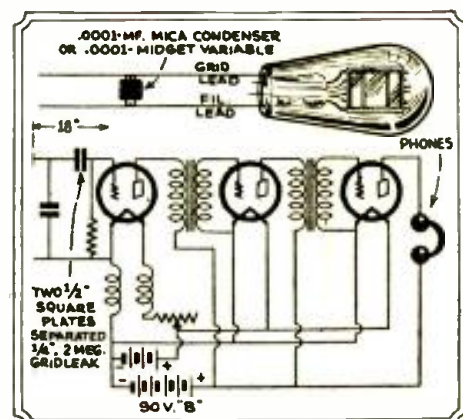

Connection of tubes in ultra short wave receiver, suitable for use in locating ore.

Short Waves for the Broadcast Listener

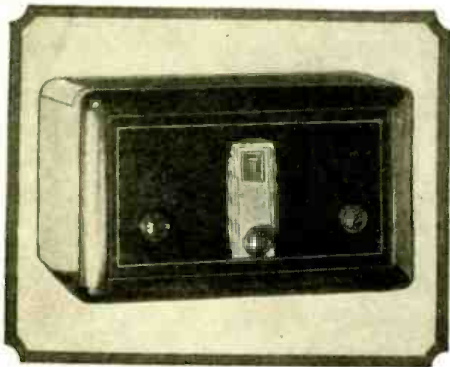

Handsome appearance of the new National short wave converter; operates without "plug-in" coils.

A NEW CONVERTER of Novel Design

By JAMES MILLEN*

"Interlocking" and "dead spots" are eliminated by new engineering ideas in converter design, which include variable-mu tube; novel oscillator circuit; a stage of high-gain intermediate frequency amplification; a new switch to eliminate plug-in-coils; similarity of dial settings for different coils; easier tuning and a brand-new dial, which "shows a different color for each wave band!"

AFTER a hurried first glance at the accompanying circuit diagram, one might be inclined to jump to the conclusion that the new "National NC-5" is merely a conventional type of so-called "short-wave converter" to which two additional tubes have been added; one a high-frequency pre-amplifier, or input tube; and the other a lower-frequency I.F. amplifier, or "output" tube.

Fundamentally this is partially true, even though it fails to consider the many months of careful laboratory development work before such additions were possible. As Robert S. Kruse stated, in the introduction to one of his articles in *SHORT WAVE CRAFT* some time ago (June-July, 1930) on the design of a short-wave receiver: "The circuit diagram should not be taken too seriously, as all the circuit diagrams in the world mean little if anything when it comes to short-wave receivers."

Short-comings of Some Converters

In the past the so-called short-wave converters have merely been frequency

changers and, while they would give extremely satisfactory results with many sensitive broadcast receivers, they were not at all universal in their application and frequently resulted in excessively poor signal-to-noise ratio. Moreover,

practically all of the commercial models that we were able to secure and test in the laboratory, during the past year, had bad "interlocking," which made tuning extraordinarily difficult. Although frequently advertised as being "single-control," such was generally far from the case.

In order to improve the signal-to-noise ratio, the stage of pre-amplification was developed, to insure efficient antenna coupling and the application of a signal of sizeable magnitude to the grid of the first detector, or mixer tube. To avoid complicated tuning, as well as intricate constructional details, due to the introduction of an additional set of coils and tuning condenser for the input to the radio stage, the special harmonic-tuned input arrangement, shown in the diagram, was developed.

Variable-mu Tube Solves Riddle

This trick was an outgrowth of a circuit designed in the National Company's laboratory back in 1926, when we were working on the original National short-wave receiver, but which lacked commercial possibilities until the advent of the UX-235 variable-mu tube. When used in

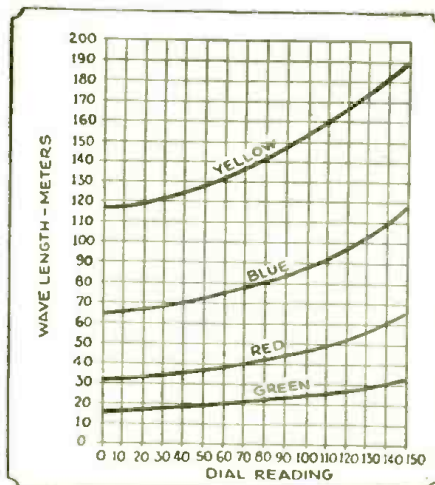

Curves showing wavelengths covered by the various coils in the National converter.

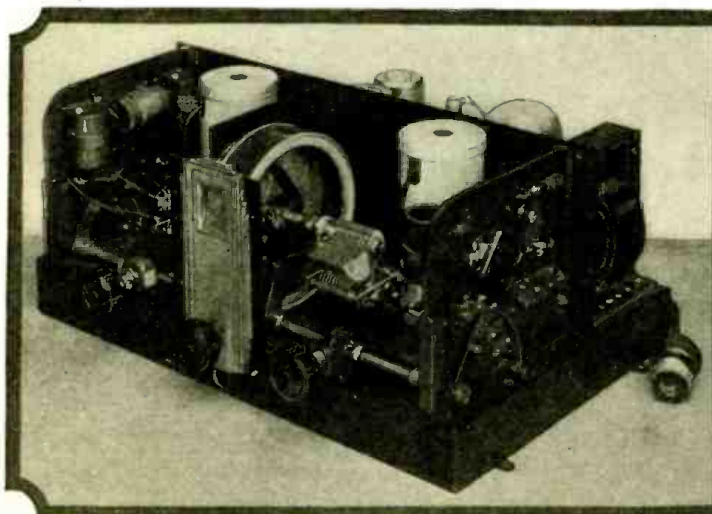

Front view of the National "Plug-less" S-W converter.

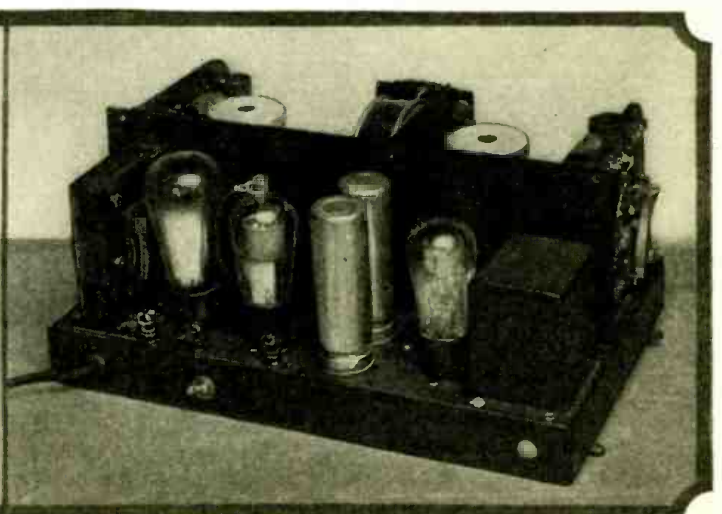

Rear view of converter, which has inductance change switches

The Short Wave Beginner

A 2-TUBE Receiver That REACHES the 12,500 Mile MARK

By WALTER C. DOERLE

This low-priced head-phone receiver comprises a few well-chosen parts arranged in a well-tried circuit.

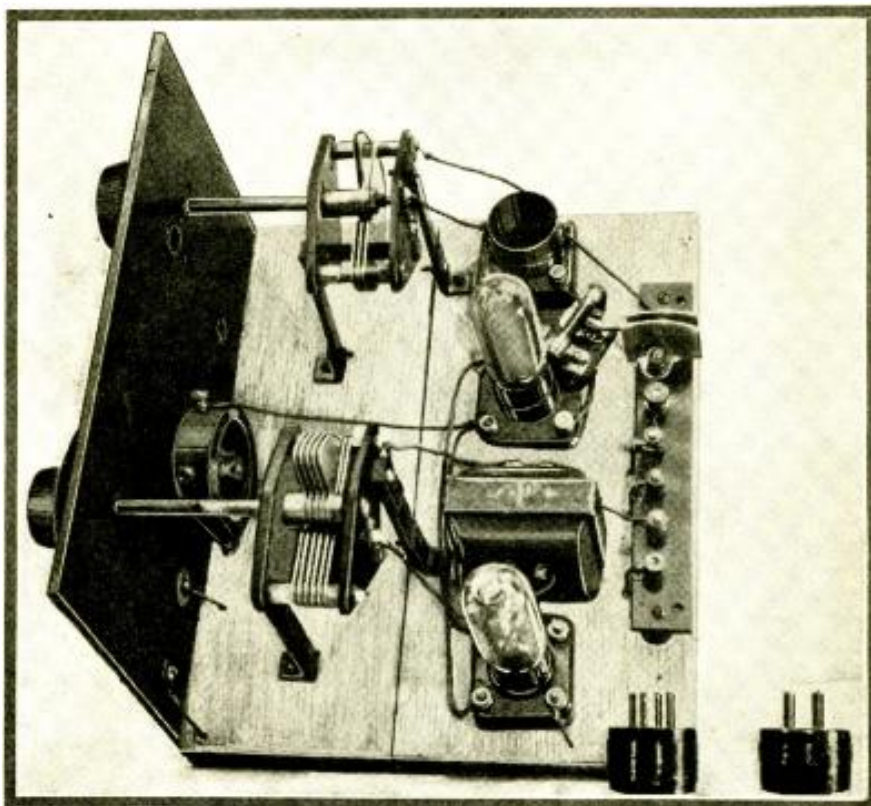

An easily built short wave receiver for the beginner, using but few parts of low cost. Note anti-capacity condenser controls.

WHAT the heck's" the idea of wasting power, of blasting out ear-drums, of going "bugs" with the performance of a costly short-wave receiver, when you can build a two-tube outfit that gets signals from the 12,500 mile meridan? Why, there is nothing to brag about when you "log" a bunch of stations with a powerful receiver; but listen to a man who "pets" a two-tube set, and then you get the "thrill of a lifetime".

It's quite possible to continue the entertainment with words, but our problem is to tell how you too can get thrills that will last a lifetime. Here we go on

our journey of description—hold your breath, read vigorously and absorb all details—everything is important.

Good night, my pencil is nearly worn to the wood and I haven't even let you fellows in on a diagram; but here she follows and with the losses reduced maybe to a third, because of careful and thoughtful construction and consideration, you could very well guess it's our old timer—the Schnell method of regeneration control for the detector, and a stage of audio frequency. (See hook-up diagram.)

We know that some people write backward and think forward; but let's start the discussion just as you perhaps draw a radio hook-up diagram—starting with the antenna symbol and completing the diagram with a few curves or loops to represent the output load—in our set we intend to use head "phones".

Antenna and Ground

Now as to the antenna, a wire strung twice across the living room and anchored to the picture molding with small finishing nails, together with a good "water-pipe" ground connection, has enabled the author to pick up signals with such a receiver from stations 6,000 miles away, even on a hot summer day, on the Pacific Coast (Oakland, California.) Say, fellows, if a well-insulated outside antenna had been possible of erection,

why the other 6,500 miles of "no-man's land" would have been easily heard and conquered.

Time is moving along, and there is much ground yet to be gained. Let us consider for a moment the antenna "series condenser". For the operator's convenience, a seven-plate midget is quite suitable for the purpose; but in a small receiver of this price, a condenser made of two pieces of old condenser plates, cut to about 1½ square inches in area and spaced on the binding-post strip ¼" apart, will serve very well for coupling the R.F. energy from the antenna to the oscillating circuit of the receiver.

Keeping Down Those "Losses"!

Be sure that the post strip is of bakelite; as this is the cheapest, though not the best, insulation for the purpose. In some experiments made by the author, a home-made series condenser was mounted on ¼-inch plywood baseboard, but a surprise awaited—the signal intensity as heard in the phones was about three-quarters its value when the series condenser plates were mounted on the bakelite strip. If there is nothing else to gain from this article, be sure that, when you make a two-tube set, you keep all losses as low as possible. It's hard to compensate for them.

Since this type of receiver would un-
(Continued on page 285)

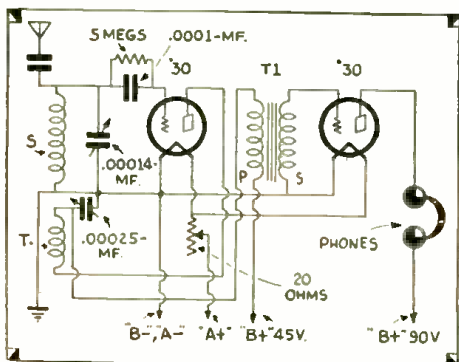

Circuit used by Mr. Doerle for the 2-tube "globe circler".

A "TRAP CIRCUIT" for SHORT WAVE RECEIVERS

I HAVE always enjoyed most reading the experiences of other short-wave enthusiasts and therefore I would like to see published this idea, which I have evolved after a great deal of experiment. By including the trap circuit shown in the diagram, I have obtained a 40 per cent increase in signal strength from a standard short-wave receiver circuit, and also eliminated the program of our local broadcast station which, without it, is heard weekly over the entire dial. Reception I can compare to another stage of average transformer-coupled audio; it is very much clearer, and there is no trouble with audio howl or feedback.

Sometimes, when using this improved circuit, it is necessary to reduce the tickler coil, as the set oscillates better without it; and a ground is not necessary. It is sometimes desirable to put a 500,000-ohm Centralab variable resistor in the plate lead at X, to obtain the exact plate voltage for best operation; a 1-mf. condenser shunts it.

The parts required are:

L1, L2—Aero "LWT 11" short-wave coil kit;

A 40 per cent increase in signal strength and elimination of interference from a local broadcast station, are claimed for this "trap circuit" devised by Mr. Swenson.

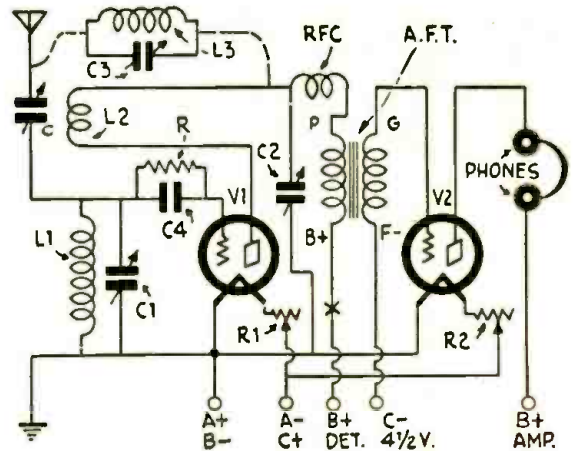

- L3—Coil of 42 turns on a 3-inch tube;
- C1—National .00015-mf. "Equicycle" 270° condenser;
- C2—National .00025-mf. "Equicycle" 270° condenser;
- C3—Variable .0005-mf. condenser;
- C4—Sangamo .0001-mf. grid condenser;
- RFC—Silver-Marshall short-wave choke;
- AFT—Pilot "391" audio transformer, 3 1/2:1;
- R—5-megohm resistor;
- R1, R2—Frost 30-ohm rheostats;
- V1, V2—De Forest 401A tubes (very efficient for short waves);
- Phones—Baldwin.

I have received these stations very clearly (at Hot Springs, Ark.) using this hookup:

W3XAL—Bound Brook, N. J.	49.18
W2XE—New York City	48.99
W9XF—Chicago, Ill.	49.83
VE9CL—Winnipeg, Canada	49.50
VE9GW—Bowmanville, Canada	49.17
W8XK—Pittsburgh, Pa.	48.86
W2XAF—Schenectady, N. Y.	31.48
W8XAL—Cincinnati, Ohio	49.50
W1XAZ—Springfield, Mass.	31.35
HRB—Tegucigalpa, Honduras	48.50
W9XAA—Chicago, Ill.	49.31
W2XAL—New York City	49.61
VZA—Drummondville, Can.	62.70

Not to mention the amateurs and C. W. stations.—Contributed by C. R. Swenson.

Simple Sending Antennas for Amateurs

OF the very greatest importance, in determining the efficiency of a transmitter, is the use of a good antenna, of exact dimensions; so arranged that, according to its function at any time, all the possibilities are fully utilized. Especially in the city, it is often very hard to maintain good radiation; since a great part of the energy is absorbed by the surroundings

has the advantage of letting the actual radiator be placed at even a considerable distance from the sender. The flow of energy through the feeder takes place almost without loss. The correct construction of such an antenna presupposes certain knowledge, which is important for determining the length of wire.

make it possible to work on both waves. The radiating part is, therefore, 20 meters long; this corresponds, for the 40-meter wave, to half of the wavelength, and for the 20-meter wave to the full wavelength. Therefore, no change is needed.

The feeder on the other hand, is so erected that the last 5-meter section (one quarter of the 20-meter wave) is located in the transmitting room and can be switched in and out of circuit. If, for example, the wire is 30 meters long, then this is suitable for the 40-meter wave; as it equals 3/4-wavelength. With the 20-meter wave, however, it is an even multiple (6/4-wavelength); and it could not be used. But, by switching in the last 5 meters, we obtain 35 meters, or 7/4-wavelength. (Five meters equal 16 feet 4 7/8 inches.)

The feeder must be at least 8 to 12 inches away from the wall, but can follow any desired course; even around corners.

A Simpler Antenna Arrangement

The second very popular type, known as the "Fuchic antenna, is characterized by great simplicity and lack of sensitivity to fluctuations. Fig. 2 shows the theoretical plan. It consists of a single wire, which is connected at one side with an oscillating circuit coupled to the transmitter. The excitation takes place by voltage-feed; and the length of the

(Continued on page 298)

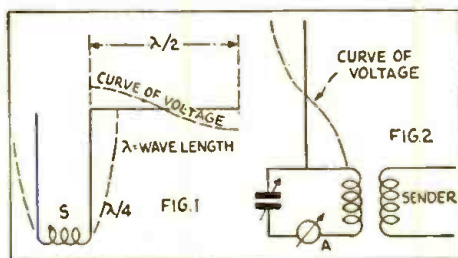

Diagram above shows distribution of voltage along short-wave antenna; Fig. 2 shows new single wire antenna, which connects to one side of oscillating circuit.

(metal roofs, trees, etc.). One must therefore endeavor to arrange the antenna so that the radiating part of it is placed as high in the clear as possible.

The amateur can consider only an antenna of simple construction; therefore, only two kinds are generally used. The "Zeppelin" antenna utilizing a feeder

Dimensions of the "Zepp" Antenna

Fig. 1 shows, schematically, the distribution of voltage along the antenna. The feeder consists of two parallel wires, 4 to 6 inches apart; between the ends toward the transmitter there is connected a coil "S" consisting of a few turns, which is coupled to the transmitter.

At the other end, connected to one of the two parallel wires, is a single wire—the radiator—which must be stretched where it is free of interference. The length of the feeder must be so proportioned that, at the upper end there is an "antinode" or peak voltage. It will therefore depend on the length of the wave to be sent and must be an odd multiple of one quarter of the wavelength. The length of the radiator, on the other hand, must be half the wavelength, or any multiple of this; since otherwise there will be no radiation. In designing such an antenna, one must take care that it will radiate at both 20 and 40 meters. (Slight variations, say 5%, are of no importance.) We may select values which will

A SHORT-WAVE Super-Converter That's Different

A new, easily operated, short wave converter recently perfected by McMurdo Silver, prominent radio engineer. The waveband coils are changed by means of an ingenious switch, thus eliminating "plug-in" coils. Short waves can be received on any broadcast set with this converter.

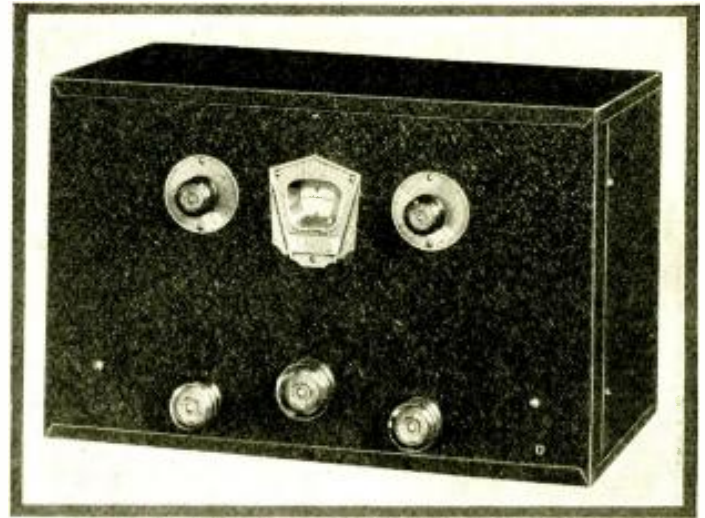

Above: Front panel appearance of the new Silver-Marshall short wave converter. Tuning in short waves is really very simple, once this converter is connected to your regular "broadcast" receiver. All the tuning is done with the single dial on the converter, the other knobs being used for volume control, coil switching, etc.

Left: Appearance of the new Silver-Marshall "short and long" wave receiver, described in detail in the last issue of SHORT WAVE CRAFT.

to a single control knob projecting through the front panel.

The wave-changing switch has four positions and provides tuning in the following wave-bands: 10 to 20 meters; 20 to 40 meters; 40 to 80 meters; 80 to 200 meters.

The small knob, at the right of the main tuning dial, changes the antenna lead from the "converter" to the "antenna post" on the "broadcast" receiver with which the converter is operating. This allows the permanent installation of the converter, with optional "short-wave" or "broadcast" reception at will. The converter is mounted in a neat steel cabinet with black crystalline finish.

Converter Uses Only Three Tubes

The "S-M 739" Super converter is a full A.C.-operated screen-grid one, with (Continued on page 293)

THERE are many different kinds of short-wave converters being sold on the radio market today, but it does make a difference "who" builds the converter you are eventually going to purchase.

Mr. McMurdo Silver, well-known radio designer of Chicago, has recently evolved a brand new circuit for a shortwave superheterodyne converter; by adding this to his set the owner of an ordinary "broadcast receiver" can listen to short-wave stations all over the world.

What the Public Expects of a Converter

From any short-wave converter the average radio enthusiast expects to obtain, today, simplicity in adapting or connecting the converter to the broadcast receiver. If possible, he also wishes to have ease of adjustment and tuning without bothering with "plug-in" coils. Finally, the converter should tune easily and smoothly. All of these features are found in the new Silver-Marshall converter here illustrated and described.

Wave-band Coils Changed Easily by Turn of Switch

The various oscillator coils for the different wave-bands are wound on special low-loss insulating tubing; as the diagram shows, the various coils are switched into circuit as required by means of a three-gang switch, connected

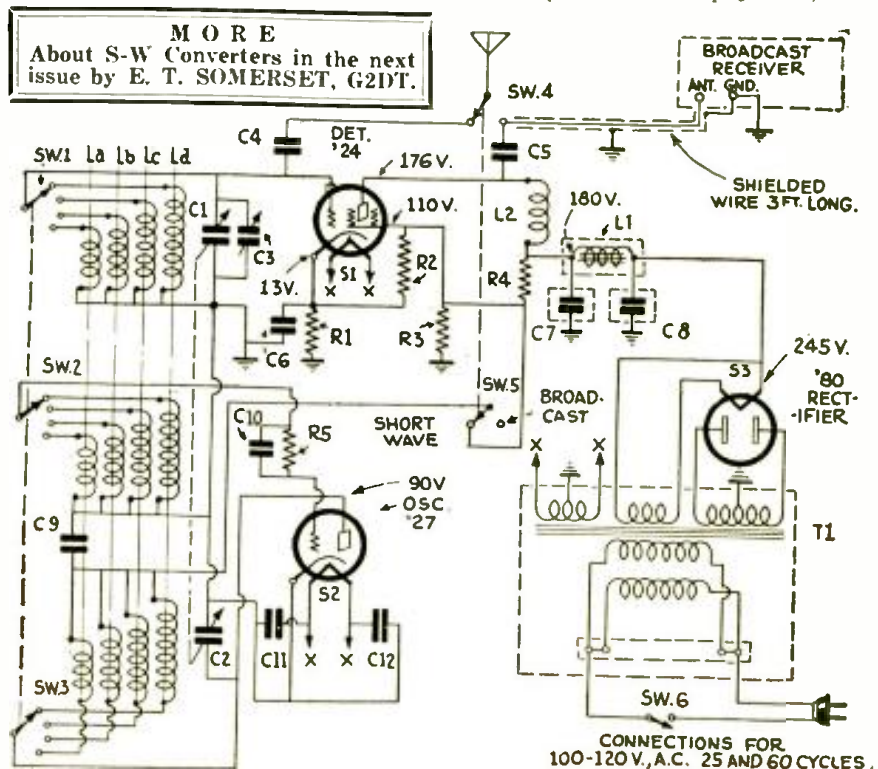

Wiring diagram of the new Silver-Marshall short wave converter here described.

MARVELLOUS RECEPTION

By Coupling Short & Long Wave *"Super-Hets"*

By BURT H. TAYLOR
(W1KB) Haverhill, Mass.

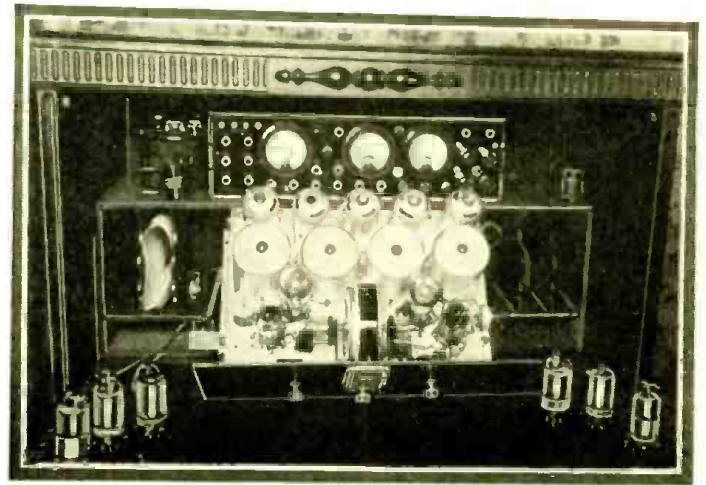

The Hairy-Young "short wave super-het" used by Mr. Taylor in conjunction with his Graybar broadcast super-het, to listen in on the "whole world".

THIS arrangement, I am certain, is one of the best, most complete, automatic all-wave receivers, and one that will perform with anything shown so far; and on top of that it is a wonderful "code" receiver.

Long-distance short wave stations are received by Mr. Taylor with tremendous volume on loud-speaker, thanks to a simple coupling between a short wave and a broadcast super-het.

operation of turning the one dial, on the Graybar; the short wave I.F. (intermediate frequency) on the "HY-7" is dropped and the cord between the two receivers then acts automatically as the pickup for WLW or WEA! And, of course, "Radio Roma" or G5SW still is "all tuned up" and, by again setting the Graybar dial back to 1530 kc. (and these sets will do this if correctly lined up) there you have the short-wave broadcast again!

In plugging the cord to the second detector, the connection is to "grid" on the socket; I should have added that the grid-leak is first removed. Another way of doing this is to plug into the "plate" at the same socket (2nd detector) and then adjust the regeneration control for best results and leave it.

You see, this whole thing is about the simplest arrangement and quickest to work that one could wish for—either tune the short-wave dial (with the Graybar dial set at 1,530 kc.) or tune the Graybar dial for "straight" regular programs. Now, in regard to performance,

Hears Foreign Amateur Stations

I have tuned in programs from literally everywhere, listened to Amateur

(Continued on page 280)

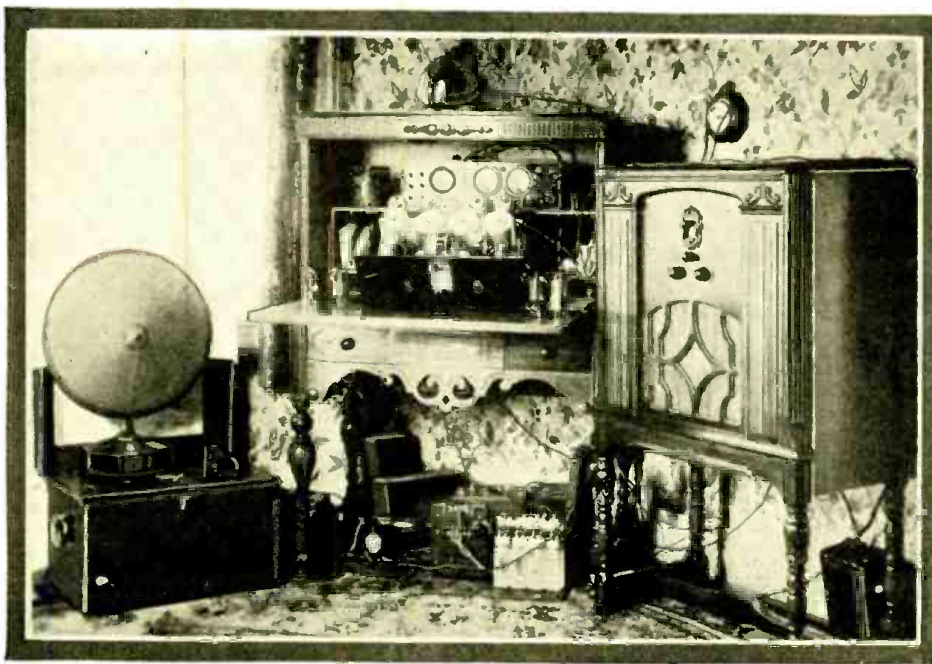

Mr. Taylor's complete layout, showing broadcast super-het at right, short wave super-het at center, with loudspeaker and power amplifier at left.

Here is the layout—a complete "HY-7" Short-Wave (super-het described in the April-May, 1931, issue of SHORT WAVE CRAFT) receiver and a standard broadcast super-het (Graybar 700, R.C.A., GE., or Westinghouse).

The intermediate train of the "HY-7" is tuned to 1530 kc., this being just below the broadcast band. Now, to use the combination of the two receivers, a test cord about 7 or 8 feet long with a plug on each end (the one I use belongs to a Diognometer) is used between the two receivers—one end connecting to the antenna post of the Graybar super, and the other end plugged to the grid of the

second detector socket, after the second detector tube has been removed; thus giving three stages of I.F. (1530 kc.) in the "HY-7," ahead of the standard broadcast receiver, which is now dialed down to 1530 kc. All short-wave tuning is now single-control on the "HY-7," using the volume control on the Graybar for "output" control.

Dual Wave Reception Simple

Now suppose we are listening to G5SW or "Radio Roma", and want to come in on WLW or WEA. All that is necessary is—simply to turn the dial of the Graybar to WLW's wave; just that one

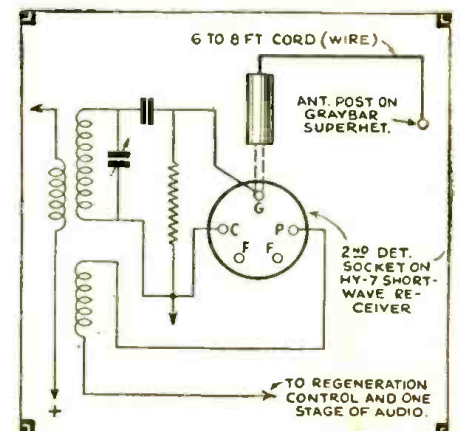

Simple connecting wire used by Mr. Taylor in joining broadcast and short wave super-hets for phenomenal long distance reception.

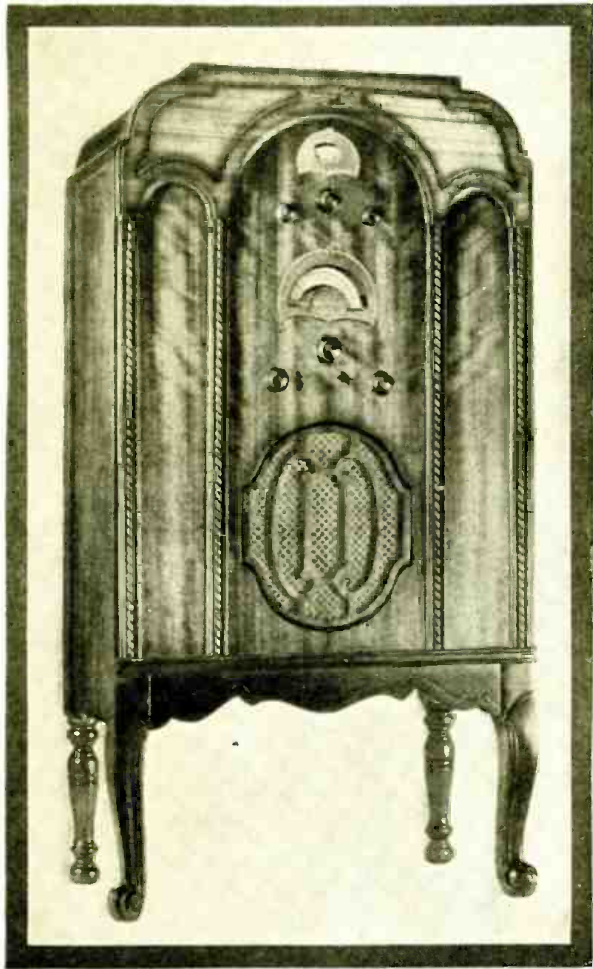

A NEW CONSOLE RECEIVER

for

Short and Broadcast Waves

The absence of "plug-in" coils for receiving the different wave bands, is one feature of this combination short and broadcast set; television reception is provided for, and there is a pentode tube in the output stage of the broadcast super-het receiver.

The "short wave" tuning dial and control knobs are in the top group on this new Stewart-Warner console; the larger dial and knobs below, are for tuning in the broadcast waves.

Chassis Details

All electrical units are mounted on a heavy rectangular steel frame, which insures absolute rigidity and prevents wiring connections from becoming loosened, due to accidental jolts or careless handling.

THE classic grace of line of French provincial cabinet work is beautifully expressed in this charming console. The top is a panel of selected American Walnut; the front is Oriental wood, with contrasting overlays of imported Koa wood, with soft, lustrous rubbed finish. The console houses the new six-tube super-heterodyne Stewart-Warner broadcast receiver with electro-dynamic reproducer and built-in

short-wave converter models are available for 60-cycle A.C., 25-cycle A.C., and for D.C. but not for battery.

"Short Waves" at Turn of a Knob

Change-over from standard broadcast band to short-wave band between 20 to 200 meters is instantly accomplished by turn of a single control knob.

Six tubes are used as follows: two '24-type tubes in the first- and second-detector stages; one '27-type tube as an oscillator; one No. 551-type (or 235-type) Variable Mu tube in the intermediate-frequency amplifier; one PZ-type (or '47-type) pentode tube as an audio-frequency amplifier; and one No. '80-type rectifier tube to furnish plate current to the set.

This circuit incorporates a pre-selector stage, a first-detector or "mixer" stage,

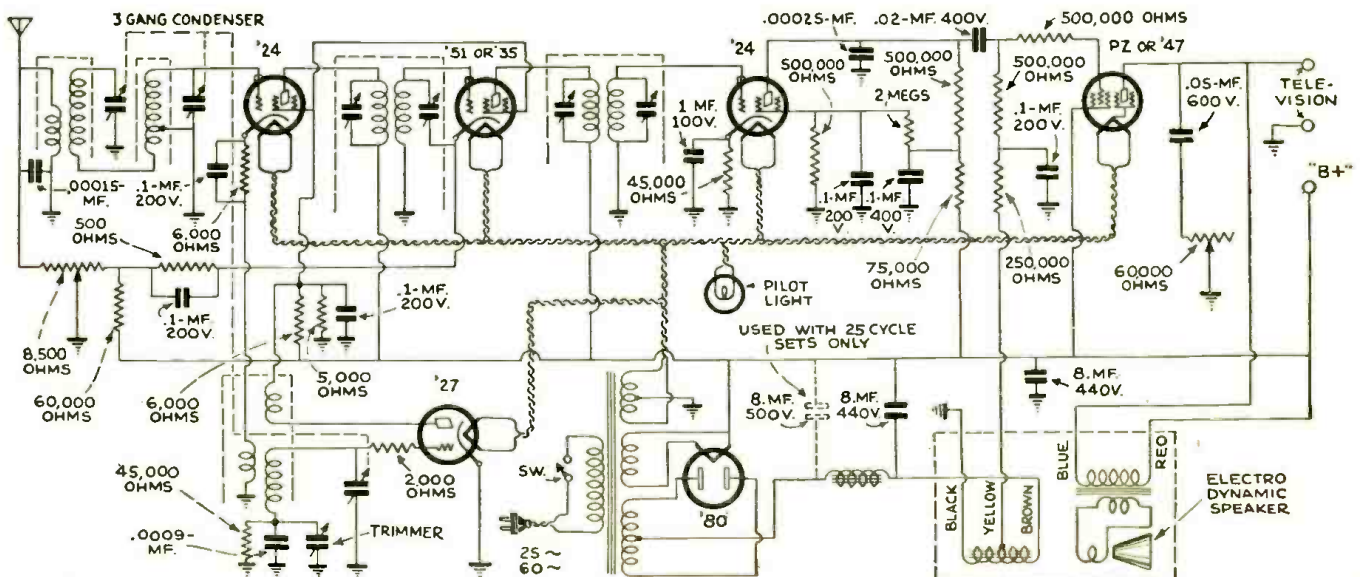

Wiring diagram of the new Stewart-Warner super-heterodyne broadcast receiver, using a pentode tube in the output stage, with television terminals provided as shown.

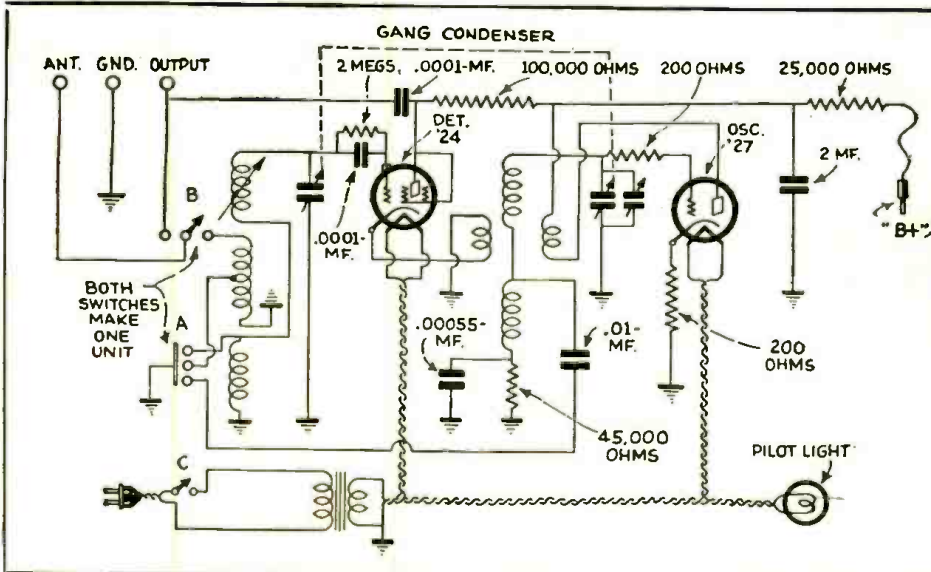

Above—Appearance of new Stewart-Warner short wave converter of the super-het type, supplied separately if desired; the same S-W converter, shown diagrammatically at the left, is also “built in” on the new Stewart-Warner console for broadcast reception.

an oscillator, an intermediate-frequency stage, a second-detector stage and an audio-frequency stage in the order named.

The radio-frequency coils and the oscillator are shielded with aluminum enclosures, and steel shields cover the intermediate transformer coils to prevent extraneous electrical disturbances from impairing reception. Volume control is accomplished with a hand control knob operating a variable resistor, so connected in the circuit that it gives maximum volume, without overloading the detector stage.

An output transformer is provided to protect the reproducer from damage, due to the high voltage of the last stage, and to improve the tone quality, by keeping

the flow of direct current out of the speaker windings.

Overall dimensions of the chassis are: 7 $\frac{3}{16}$ in. high; 12 $\frac{3}{4}$ in. wide and 11 $\frac{1}{2}$ in. deep.

The “Plug-less” Short Wave Converter

While most standard sets are limited to domestic reception only, the new Stewart-Warner short-wave converter now extends their range of reception beyond the seas and makes possible the direct reception of foreign broadcasts, police, amateur and television signals. This new converter is a built-in feature of the new console and also portable sets. It may also be purchased separately, in the compact walnut-finished cabinet illustrated, for use with practically any 110-volt alternating current (A.C.) set.

Unlike commonplace converters, this converter does not require changing a number of coils, or the manipulation of several dials to tune-in at various low-wave lengths; it incorporates fixed coils that do not require changing. Tuning is controlled by a single dial only, in conjunction with a “range” switch. By turning this switch to the left, the converter is turned off. Turning it to the next position to the right permits the converter to cover from 1,500 to 4,660 kilocycles; turning it to the extreme right permits the converter to cover from 4,610 to 15,120 kilocycles. Thus, the converter covers all frequencies from 1,500 to approximately 15,000 kilocycles—or a wavelength range from 200 down to approximately 20 meters.

(Continued on page 299)

WHEN TO LISTEN IN By “BOB” HERTZBERG

Another Woman Announcer

THE woman announcer at station 3IRO is well known to all listeners who have tuned in “Radio Roma Napoli.” Her place in front of the microphone was endangered by a recent decree of the Italian broadcasting authorities, who had decided to replace her and the other woman announcers at Italian stations by men. However, a flood of complaints from listeners all over the world has caused a change in this order, and the women—Lord bless ‘em—will remain.

Another woman announcer is making a bid for honors. She hasn’t been heard yet in the United States, to the best of my knowledge, but she is beginning to attract attention in Europe. She broadcasts from a new Soviet short-wave station in Leningrad, which has the call letters RVKI and is supposed to be working on 31.1 meters. This station is reported to be testing from 2.00 to 3.00 o’clock in the afternoon, Eastern Standard Time. If you hear it please drop me a card.

No Polar Broadcasts This Year

The radio tests between the submarine *Nautilus* and the National Broadcasting Company in New York, arranged with the object of possible relay broadcasting from the polar regions, seem to have been as unsuccessful as the trip itself. Sir Hubert Wilkins has been the victim of considerable misfortune on this daring venture; but he has the indomitable spirit characteristic of explorers, and he will probably succeed the next time.

Zurich

There is a station in Zurich now broadcasting regular programs, European evening time, on 32.85 meters. The call letters are HB90C. The transmissions are preceded by two strokes on a gong and the announcement “Hier Radio Zurich.”

Java

Probably the shortest wavelength used for regular short-wave broadcasting is 15.9 meters, one wave of the Dutch station in Bandoeng, Java. Musical programs are transmitted usually on Tuesdays between 1400 and 1600 GMT.

Moscow

The Russians are evidently making ambitious radio plans. There is already a powerful station in Moscow on 50 meters, and now another one, using the power of *sixty kilowatts*, is projected. Details of wavelength, hours of operation, etc., have not yet been announced.

Portugal

I am glad to present some “dope” on station CF1AA, which has been mentioned vaguely in this department. This is a private station owned by Señor Abilio Nunes dos Santos. This ordinarily works on 291 meters, but it has a 42.9 meter short-wave channel working on Thursdays from 5:20 to 7:20 p. m., EST. Announcements are made in Portuguese, and also

French, English, German and Italian. This fashion of announcing in a number of different languages was started by P.C.I. and is being adopted by other stations to make identification on the part of the listener easier.

France

Station FYA, the French colonial station located just outside of Paris, is being heard with great regularity in the United States. I am indebted to Mr. Vincent Ryan, 16 Hamilton Avenue, South Norwalk, Conn., for a copy of its complete operating schedule, which was sent by Mr. Ryan along with a letter verifying his reception of the station’s programs. I quote from it as follows:

“Our transmissions are being made at the present time with an antenna power varying between 12 and 14 kilowatts, at the following periods:

“On 19.68 meters, from 14:30 to 17:30 GMT. Intended particularly for the French colonies in Asia.

“On 25.20 meters, from 18:30 to 20:30 GMT. Intended particularly for the African colonies.

“On 25.63 meters, from 21:00 to 23:00 GMT, intended particularly for America.”

Many interesting programs are broadcast by FYA. Recently General Pershing appeared before its microphone, and was heard by many short-wave fans in the United States.

(Continued on page 299)

The A. C. SUPERREGENODE

By CLIFFORD E. DENTON

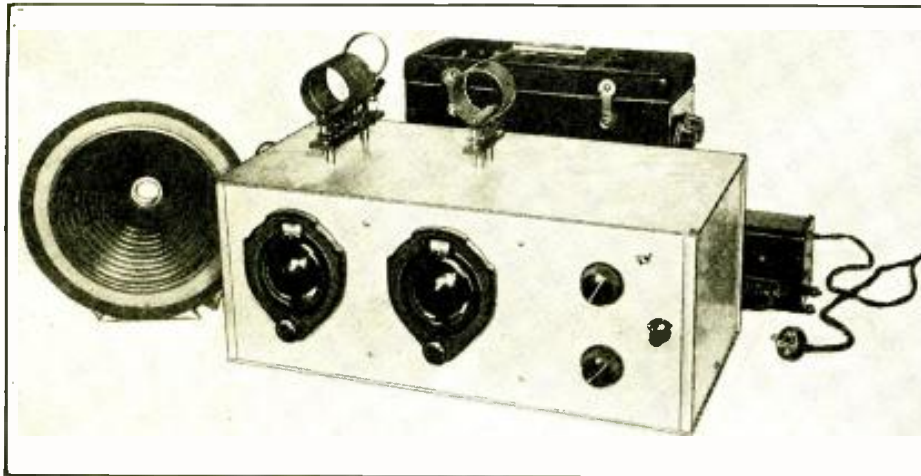

FIG. A

The A.C. receiver, showing the exterior coil mountings. The external "B" power unit, filament transformer, and dynamic speaker appear behind it. The controls are easy to operate.

A superregenerative receiver of extraordinary sensitivity on the highest frequencies; simple in construction and certain in its operation with the high power obtained with A.C. Operation. The D.C. model was described in the last issue.

Modifications of the circuit may be employed; such as placing the oscillator's pick-up coil in the cathode lead, instead of the screen-grid lead, of V1; still controlling the oscillation by varying R1 (see Fig. 1A).

Various methods for the construction of the local-oscillator circuit were shown in the preceding article. The constructor may consult this or, if he prefers, use his own pet oscillator design. The Superregenerative is sure to work if the fundamental principle is followed and the oscillator V2 feeds enough energy to V1; at 90 volts on the plate, the '27 type oscillator will deliver ample power.

High Audio Output

The audio end has been redesigned, to give larger output on *weak* signals. An output pentode was retained for the final stage, but with the added power of a '47; while a first A.F. stage tube V3 was added. The latter is of the '24 screen-grid type, with resistance-capacity coupling into the power stage. A consideration of the effective circuit (Fig. 2) will show that an A.F. signal of only .029-volt will develop the full 2.5-watt output of the pentode; that is, the total effective voltage gain of the audio amplifier is approximately 8,500.

Although such a first A.F. stage may be included in the battery model, the type '32 tube has been found to have microphonic tendencies when so used.

The increased output brought the speaker volume to such a point that it was uncomfortable to listen to American stations, especially, even in a large room. On extremely weak signals, however, the receiver was tremendously pepped up; while the reproduction obtained with the transformer-coupled input and inter-stage resistance coupling is of very high quality.

THE author's article on the D.C. "Superregenerative," which appeared in the last issue of SHORT WAVE CRAFT, has occasioned many favorable comments, judging by the immense amount of mail received from readers. The special information requested by some of those interested in building the superregenerative is given in this article describing the A.C., model of the instrument.

First, let it be said that, tube for tube, the super-regenerative circuit gives greater sensitivity than any standard regenerative arrangement on short waves; and the advantage so gained increases as the wavelength shortens. Equal selectivity may be obtained by the use of an equal number of tuned circuits.

Experiments indicate that the best value for the locally-generated suppressor-frequency (the action of which was fully explained in the preceding article) is in the order of 1/1000 of the received signal frequency; that is, the former is expressed in cycles corresponding to the kilocycles of the latter. (See the appended Table I.)

At the highest frequencies, therefore, the locally-generated frequency is quite inaudible; it falls to 7,500 cycles only above 40 meters (7,500 kilocycles)! At five meters, the local oscillator should be a radio-frequency generator, with an output of 60,000 cycles. For this reason, the suppressor-frequency causes no interference and requires no audio filtering for the reception of broadcasts on very short wavelength. At the same time, the sensitivity of the receiver increases steadily as the signal frequency becomes higher.

Alterations Give Efficiency

The A.C. model incorporates a few improvements which make its perform-

ance vastly better than that of the battery model previously described. The greater sensitivity of the type '24 tube, which is less critical in adjustment than the '32, improves the R.F. end considerably. An additional stage of audio has been incorporated, and gives a tremendous increase in volume on distant stations; other considerations dictating its addition are discussed later.

The previous method of tuning has been retained; but, for convenience in exchanging them, the plug-in coils are mounted externally. Once the plate voltages have been correctly regulated, and the screen-grid voltage control adjusted, tuning can be accomplished with the receiver in stable operation from one end of the band to the other. This cannot be said of the ordinary short-wave receiver.

Table I

R. F. Input Signal		Suppressor Frequency		Cap.
Meters	Kc.	Cycles	(Meters)	Mf.*
10	30,000	30,000	10,000	None
15	20,000	20,000	15,000	.001
20	15,000	15,000	20,000	.0025
24	12,500	12,500	24,000	.004
30	10,000	10,000	30,000	.006
37½	8,000	8,000	37,500	.01
50	6,000	6,000	50,000	.02
60	5,000	5,000	60,000	.03
75	4,000	4,000	75,000	.05
100	3,000	3,000	100,000	.08
120	2,500	2,500	120,000	.10
150	2,000	2,000	150,000	.2
200	1,500	1,500	200,000	.3

* Approximating computed value.

FIG. 2

This diagram, showing the effective amplification of the Superregenerative's audio circuit, which gives a margin of power for automatic control to overcome fading.

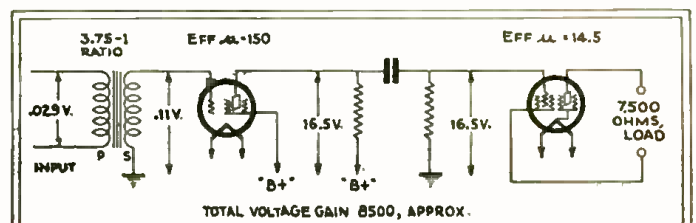

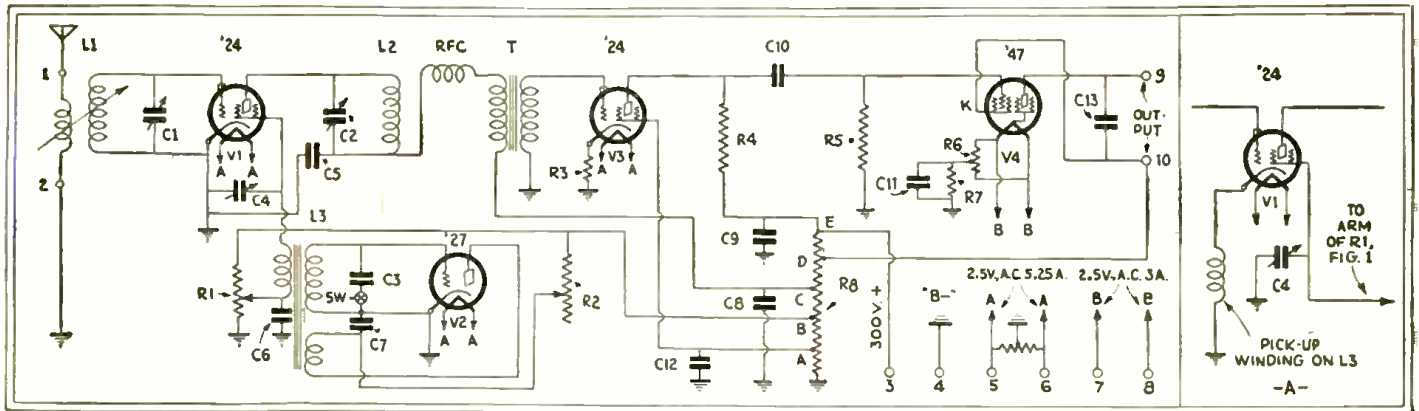

FIG. 1

The circuit of the A.C. Superregenerative follows the principle of the receiver using 2-volt battery tubes, which was illustrated in the last issue of *SHORT WAVE CRAFT*; but incorporated a screen-grid first audio stage, as well as the necessary changes for current supply. At the right, an alternative method of coupling the suppressor-frequency into the detector tube is shown.

Supplying Operating Voltages

The receiver is shown in Fig. 1 with- out its power supply (which is external); consisting of a filament transformer and a plate voltage supply. Several commercial power packs were tested; and all gave satisfactory results with the A.C. Superregenerative.

A small 2½ volt filament transformer having two windings, and a Majestic "B" eliminator were used in the combination of Fig. A. The high-voltage tap of the eliminator illustrated gives only about 200 volts; and to obtain the required higher potential, indicated in the schematic circuit, two heavy-duty 45-volt "B" batteries were connected in series and cut into the circuit, between the eliminator's high-voltage tap and the "B + 300" connection, to the receiver chassis.

This method may place two voltage dividers in shunt—one in the receiver chassis and, perhaps, one in the "B" eliminator; differences in eliminator design determine whether it is desirable to connect in the "B" supply circuit to the receiver chassis a circuit-opening switch, to prevent drain of the "B" blocks when the set is not in use. Where the "B" eliminator circuit from "B + Max." to "B —" tests "open", when disconnected from the light-line, there is no need to use such a circuit-opening switch.

Any standard '45-type power pack may be used, as long as it delivers about 65 ma. at 300 volts or more; in the latter instance, it may be necessary to connect in series with the "B +" lead of the eliminator a heavy-duty variable resistor, such as the compression-type Clarostat, with a range of zero to one megohm to reduce the voltage to the correct value to match the characteristics of the voltage divider in the receiver chassis.

The type '47 pentode operates best at a plate potential of 250 volts and a control-grid bias of 16.5 volts. In the A.C. Superregenerative, this plate or "B" potential is obtained directly from the current-supply system; while from the total output of this system must be subtracted the required "C" bias (obtained by means of bias resistor R7 and, for V3, R3).

The voltage divider in the receiver proper must be adjusted carefully to ob-

tain maximum efficiency; the setting of its taps will vary with the output obtainable from the power pack, as well as with the demands of the individual pentode tube selected. The voltage readings at the taps should be about as follows: A, 18; B, 90; C, 180; D, 250; and E, 350 volts. A slight readjustment of A may be needed to obtain maximum A.F. amplification; this is the most critical operating value in the receiver.

The use of a separate filament winding for the pentode, as specified, is not absolutely essential; it is possible to operate all the tubes from a single 2½-volt winding, to which the two sets of filament leads shown are connected.

The power supply should be kept away from the set; so that the magnetic fields between iron-core units in the receiver do not couple with the filter chokes and the power transformer.

Assembly of the Receiver

For details of the aluminum case employed, the reader is referred to the Oct.-Nov. issue of *SHORT WAVE CRAFT*. No mechanical detail drawings are included

in this article; since experimenters will use the parts that are available; and it is impossible to specify drilling holes for all the existing types of suitable equipment on the market.

If the constructor follows the mechanical design of the author (see Figs. A and B), the following method of assembly works out well:

On the top cover, mount the antenna coil and secondary plug-in base L1, and the plate coil base L2; spotting them so that they are mounted in line with their tuning condensers. The effect of placing the coils on top helps the type '24 tube to oscillate more readily; since magnetic coupling between the plate and grid coils is added to the inter-element capacitive coupling of the tube V1.

On the rear panel, or back, mount the antenna and ground posts 1 and 2, the output tip-jack terminals 9 and 10, and the receptacle for connection to external power supply leads Nos. 3, 4, 5, 6, 7 and 8.

The front panel carries the grid and plate tuning condensers, C1 and C2 respectively, which are mounted beneath (Continued on page 291)

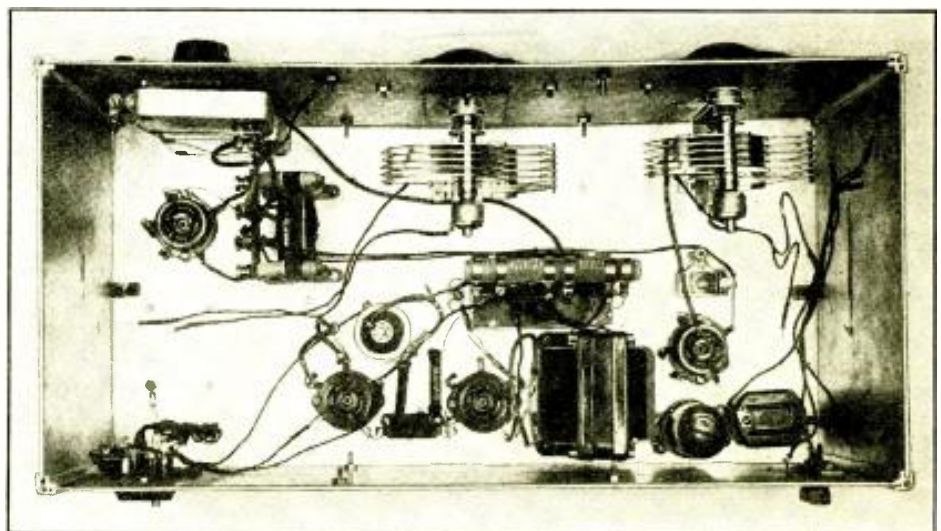
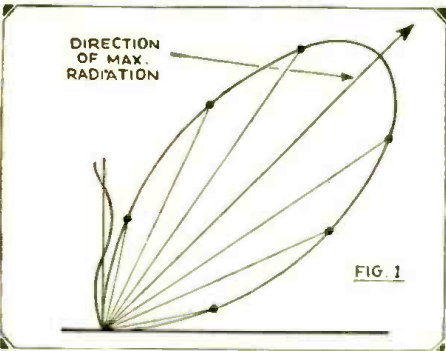

FIG. B

The interior of the A.C. Superregenerative, which is easily constructed, having no compartments in the shield. The components may be readily identified by comparison with the schematic circuit above.

How ARE SHORT WAVES PROPAGATED?

By F. BÖDIGHEIMER



This diagram shows the direction of maximum radiation from a vertical antenna excited by harmonics.

The author gives high credit to short wave amateurs who have contributed greatly to the data here presented on short wave phenomena. The question of whether short waves penetrate the Heaviside layer, thus making possible radio communication with other planets, is here considered.

miliar laws for short waves, which touch on the new problems of propagation foremost in interest. The general laws here given rest on the personal investigations of the writer in the years 1926 and 1927; but, with reference to their general physical basis, on previously known facts or theories. The special data regarding the influence of the weather are based on independent researches performed by Dr. Karl Stoye and the writer, who have had occasional interchanges of ideas. These investigations are still going on.

(1) The maximum radiation from a vertical antenna, especially if it is stimulated by harmonics, projects obliquely upward at an angle. (See Fig. 1.)

(2) A horizontal antenna radiates evenly, over an angle of nearly 180 degrees (Fig. 2),

(3) At a height of 50 to 100 kilometers (30 to 60 miles) above the surface of the earth, there is, according to Heaviside's theory, a stratum of atmosphere which, because of the sunlight and the electron radiation of the sun, is distinguished by a very large number of free negative electrons per unit of space and, because of the slight atmospheric density, by a very great number of heavy ions or positive particles. In view of the great open stretch, there takes place, by *impact ionization*, a further increase in the number

stations at night from "impossibly" great distances, received no consideration. The fact was established: waves of 300 meters and less are absorbed by the influence of the sun's rays in their course along the surface of the earth. That they were more serviceable at night and, under certain circumstances, audible at very great distances, was attributed to the absence of the solar radiation.

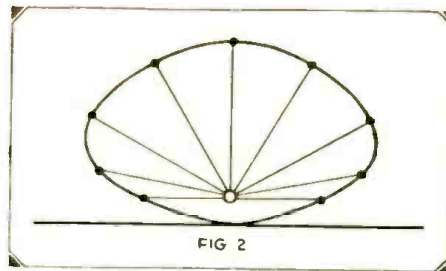

The radiation from a horizontal antenna is evenly distributed over almost 180 degrees, as shown.

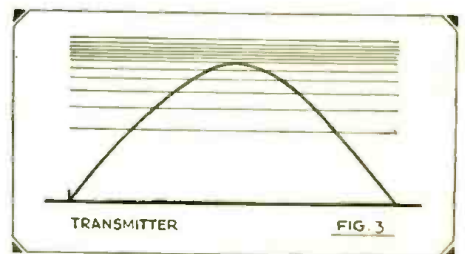

The space radiation is bent downward; more exactly it is refracted and totally reflected (at certain frequencies).

of free electrons. The electron density gradually increases in a vertical direction and again decreases. The dielectric constant of the Heaviside layer is smallest where, in consequence of very great electron density, the electrical conductivity of the layer is greatest. This gradual change in the dielectric constant effects a refraction similar to astronomical refraction (also analogous to the formation of the "Fata Morgana" and mirages) and finally total reflection of the electromagnetic radiation (see Fig. 3). The space radiation is thus bent downward.

Ultra Short Waves Pierce Heaviside Layer

(4) The refraction is, as in the case of light, dependent on the frequency. High

BEFORE the extraordinary range of short waves was discovered by amateurs, it was held as *incontrovertible* that the electric waves followed the surface of the earth, and that the strength of the field decreased in proportion to the distance. It was assumed as simply natural without its causing any more surprise and attention, that for communication at a very great distance only long waves were serviceable, with the expenditure of correspondingly great energies. Operation was carried on with wavelengths of 2 to 3 kilometers (that is, with frequencies from 150,000 down to 100,000 cycles) and with energies of many hundred kilowatts.

The shorter the wave, the less suitable it seemed for distant communication. Waves of a few thousand meters were used in continental communication, but not in transoceanic. Waves of about 1,000 meters and less were intended for internal communication and for neighboring states. Finally came the waves of 600 and 300 meters for communication of ships with one another and with coast stations; that is, mostly for very short distances.

Waves Below 300 Meters Were Considered Useless

Waves of less than 300 meters were considered entirely useless, because they actually proved very unreliable in communication at short distances; for which at any rate, they appeared in question. It did not even cause thought that, during the war, weak German ship and field stations in Turkey were occasionally heard on the 300-meter wave by crystal receivers located in Germany. Likewise, the fact that the ships with their resounding transmitters disturbed or drowned out the first 300-meter radio

* The following is a section from the book "Radioamateurstation für kurze Wellen," by F. Bödigheimer. This should be of great interest to all short wave amateurs.

Amateurs Pioneers in Short Wave Work

Now, against considerable resistance, these views have fundamentally changed. The pioneers of the new conception were the amateurs, who even today have at their disposal the greatest experience and in part stand preëminent in the clarifying of still doubtful problems. Below is a brief outline of the now fa-

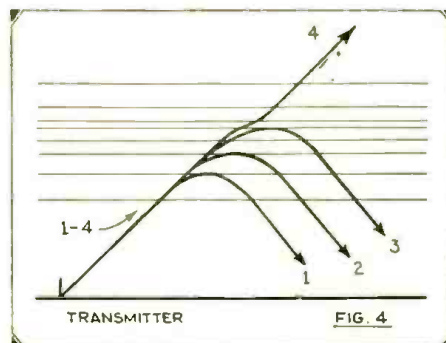

Radiation at various frequencies, 1 to 4, some of which are partly bent downward, some passing through the Heaviside layer with parallel deflection.

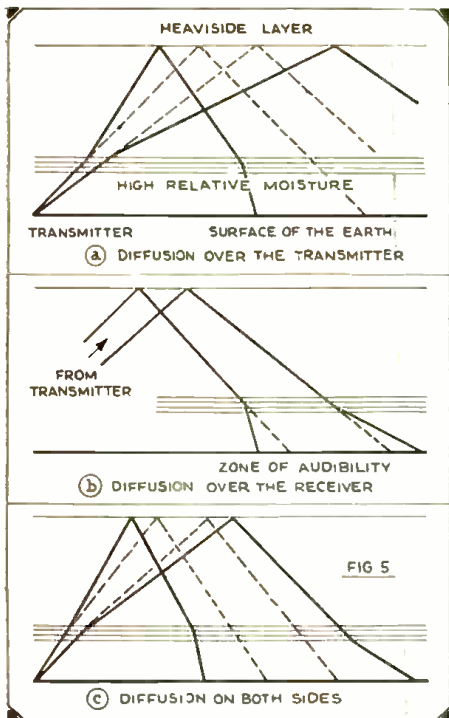

Assumed diffusion of energy by strata of high relative moisture; normal course of radiation in dotted lines. For the sake of simplicity, a straight course of radiation and reflection was drawn, instead of indicating refraction.

frequencies (short waves) are less strongly refracted than low frequencies (long waves). A pencil of electric waves of different frequency, increasing from I-IV (cf. white light) would behave as in Fig. 4. (This is similar to the production of rainbow colors in the refraction of white light.) The range is smaller in the case of long waves than in the case of short ones. Very high frequencies (ultra-short waves) are no longer refracted, but pass, with a parallel deflection, through the Heaviside layer; since, in consequence of the slight refraction, the limiting angle for total reflection is not reached. Rays striking the Heaviside layer perpendicularly pass through it unrefracted.

(5) The energy of ground radiation, whose proportion of the total radiation is great (especially with horizontal antennas) is quickly absorbed in consequence of the ion density being high near the ground, and because of other sources of loss. On the contrary, the space radiation moves along in the Heaviside layer almost without loss, because of the slight ionic density.

(6) The absorption in consequence of the greater ionic density near the ground is less, with high frequencies, than with the lower ones. The fact that the ground wave is nevertheless (as a rule) more quickly dissipated, with high frequencies, than with lower, is attributable to other sources of loss.

The Cause of "Dead Zones"

(7) Since the ground radiation is used up after a few miles, while the space

radiation descends again to the earth only after a greater distance, there results a *silent zone*, in which there is no reception or only weak signals are heard.

(8) The height or make-up of the Heaviside layer, or perhaps both factors, changes with the time of day and of year and with the changing activity of the sun spots. Therefore these factors have a great influence on the propagation of the short waves.

Best Frequency Varies With Seasons

With equal frequencies, the range is greater at night or in the winter than by day or in the summer; hence, for example, for these wavelengths:

- 20 meters by day in the summer: European communication,
- by day in the winter: DX (distance) communication;
- 40 meters by night in the summer: still European communication,
- by night in the winter: DX (distance) communication;
- 80 meters by day in the summer: almost useless,
- by day in the winter: places very near at hand;
- by night in the summer: European communication,
- by night in the winter: also DX (distance) communication.

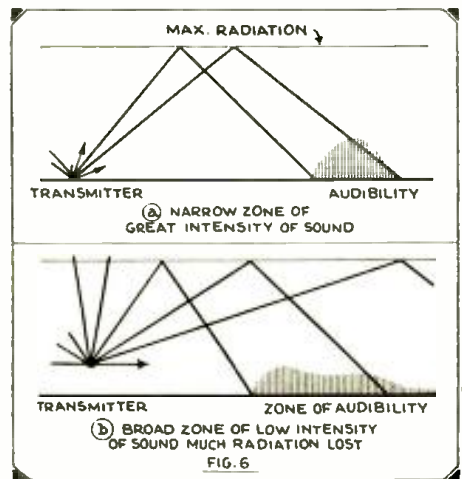

Vertical antenna (a) excited into harmonic oscillation and horizontal antenna (b) with its characteristic radiation.

(9) The shorter the wave (the higher the frequency), the better it is suited for communication by day and in the summer; but the less it is suited for communication at night and in the winter.

(10) Ultra-short waves are not deflected downward; with regard to their usefulness for communication, they behave almost like light waves. (In so far as communication with other heavenly bodies might be considered, then ultra-short waves would be the most suitable.) The limit between the ultra-short waves

and those still serviceable for "DX" (distance) is not sharp, but varies with the time of day and of year. It lies at about 10 meters, as calculation and practical experiments have shown. The present experiments with 10-meter waves therefore lead toward "DX" communication in summer and by day, which should be noted.

Condition of Atmosphere Affects Short Waves

(11) Considerable influence seems to be exerted according to investigations not yet completed, by the weather or, more correctly, the condition of the atmosphere at the edge of the stratosphere. In fact, there evidently is a considerable significance in the "moisture content" in the higher strata of air; shorter waves show themselves most sensitive to these influences. The influence of the weather is therefore stronger on 20-meter waves than on those of 40 or 80 meters length.

(12) Uniformly dry air over transmitter and receiver seems to be the best condition for good "DX" (distance) radiation (by day there is strong interference by increased absorption).

(13) Meteorological conditions, and probably also the Heaviside layer, are subject to marked changes (particularly the Heaviside layer) at twilight, and at times of disturbances in the earth's magnetism. The results are more or less rapid displacements of the zones and, therefore, changes in signal strength. This gives an explanation for "fading" which, according to the current explanation that it is caused by the difference in phase between space wave and ground wave, would be inexplicable in the case of short waves.

(14) At places in the middle of the zone of maximum sound intensity, the power of the transmitter received plays a small part. With favorable atmospheric conditions, one hears very slight energies (weak signals) with the sound intensity R9.

(15) The form of antenna, vertical or horizontal, is of distinct significance. From Fig. 6 it is evident that the horizontal antenna is more favorable for close communication (Europe); the vertical antenna, excited on a harmonic, is better for "DX" communication, though to be sure over a relatively narrow zone.

(16) From the viewpoint of short waves, it is also possible for us to look differently at long waves. Here too the ground wave is far from playing the part still assigned to it today. It does not reach far; with our chief German stations, in the autumn of 1930, not even 200 kilometers (125 miles).

Reception improvement in the local zone is a question of the antenna, likewise a question also of frequency! This effect should be studied carefully by those who are seeking the salvation of long-wave radio by utilizing tremendous transmitting powers.—Fank Bastler.

All-Electric SINGLE DIAL Tuning SHORT WAVE SUPER-HET

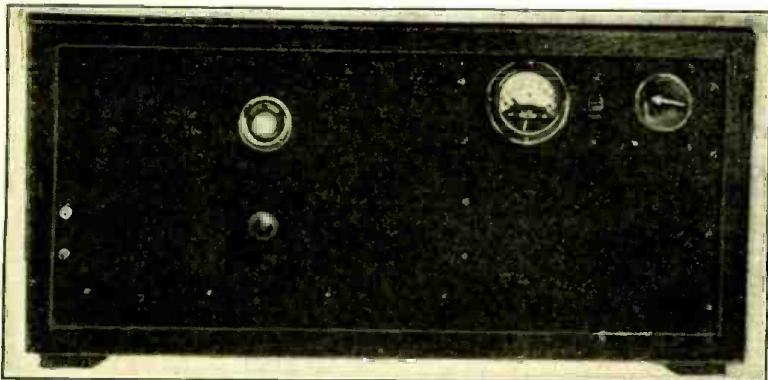

Front-panel appearance of the All Electric Super-Het of German design here described. Fig. 7.

Prize-winning receiver set entered in recent competition of the Reichs-Rundfunk-Gesellschaft; including details of the power supply. This set employs rectified A.C. for the heaters of the tubes, to minimize hum.

By K. KÖNIG

(Concluded from last issue)

The Construction

MOUNTING and wiring the set described are greatly simplified by the fact that the actual receiving chassis is completely separated from the power unit. Both can therefore be made almost entirely independent, before they are mounted together. The front panel, for which Fig. 1 gives the drilling plan, is common to the two parts; in order that there may be no hand capacity, it is made of 0.12-inch aluminum.

The Receiver Chassis

On the front panel of the receiver chassis (Figs. 2, 3, 4, and 5) there is only the variable condenser C3 of 100 mmf., a special short-wave condenser with median-line tuning curve. Con-
denser, graduated dial and vernier knob

in this type form a unified whole. The friction disc F (Fig. 2), which is attached directly to the rotor, is here behind the front panel and at the same time represents the graduated dial. The scale is read through a window (Fig. 7) which, together with the vernier knob, serves for fastening the condenser to the front panel. The condenser is directly mounted (without insulation) on the front metal plate, and the rotor is thus grounded.

The individual parts are, mostly, mounted on the upper surface of a sufficiently stable bakelite sub-panel, which lies 1.4 inches above the lower edge of the front panel (see Fig. 1). The baseboard is screwed to the front panel as well as to the power unit with angle brackets (WS, Figs. 4 and 5).

On the outside, the baseboard is sup-

ported by a strip of bakelite 1.4 x 16 x 0.16 inches, to which it is screwed with three angle brackets W. This strip carries the connection terminals for antenna, ground, and loud speaker. The arrangement of the terminals may be seen from Fig. 4. At the upper side of the extra bottom the front panel is also supported by a hard-rubber bracket W (Fig. 2). All points where wire passes through are represented by small circles, each having a dot in it; and are uniformly marked on both sides by numbers (see Figs. 2 and 4). The six little double circles designated “-G,” “+H,” “-H,” “+A,” “+A,” and “-A” (H=heater, A=anode or plate in German terminology) are terminal screws, which served for connecting the battery wires, when the receiver part was first tried out (by way of test, before the power unit

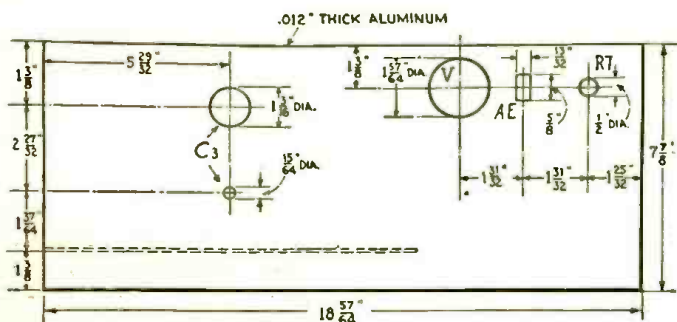

Fig. 1.

Above—Drilling plan for front panel used with the All-Electric German Super-Het here described.

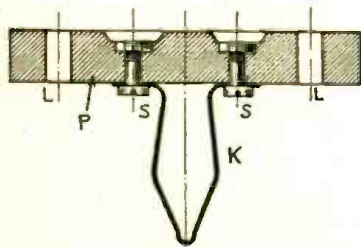
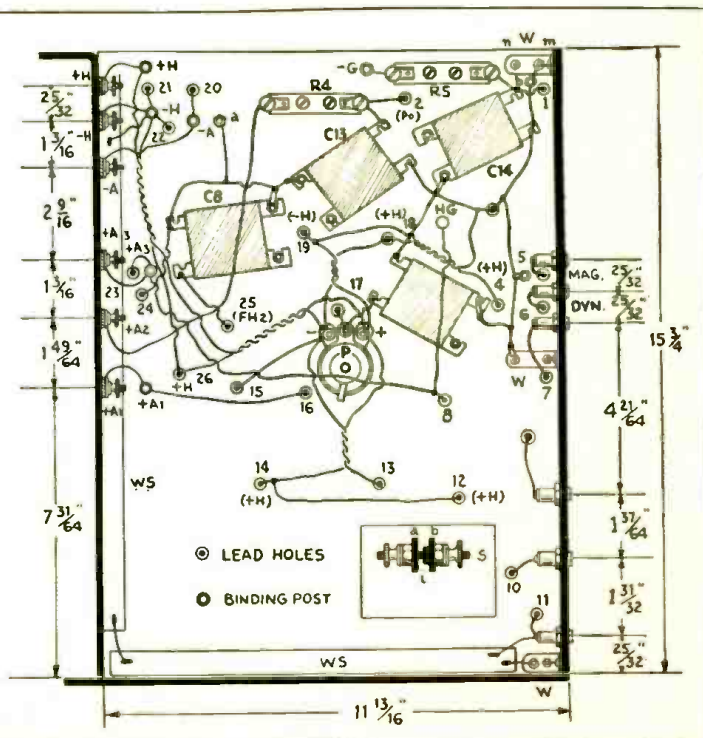

Fig. 6.

At Left—Automatic main switch operated by opening and closing cabinet.

Fig. 4.

Right—Mounting and wiring plan for the under-side of the short wave Super-Het.



was built in) with batteries or with "B" eliminator and storage battery, to be able to undertake any necessary changes in construction. At the same time this shows the way to amateurs who want to dispense with "building in" the power unit, and who wish to feed the receiver chassis from separate sources of current.

On the under-side of the baseboard, the wires are later run from the power unit to the above-mentioned terminal screws (Fig. 4). For receiving the resistors R1 and R2, as well as the fixed condensers C1, C6, C7, and C9, the resistor mountings are used on the upper side of the baseboard. The fixed condenser C2 stands vertically; it is fastened directly to the stator of C3 by its lower screw connection, while from the upper screw connection a flexible wire leads to the plate of the screen-grid tube 1. In this way the plate wire is kept as short as possible. Likewise from the upper connection screw of the R.F. choke

side of the subpanel (*d* in Fig. 4). At the right beside the grid battery is a tiny socket C with a plate ballast lamp; so that the connections "—H" and "—A" (— heater and — plate) are connected by its filament. This prevents the burning out of the tube filaments. The shielding hoods of the filter

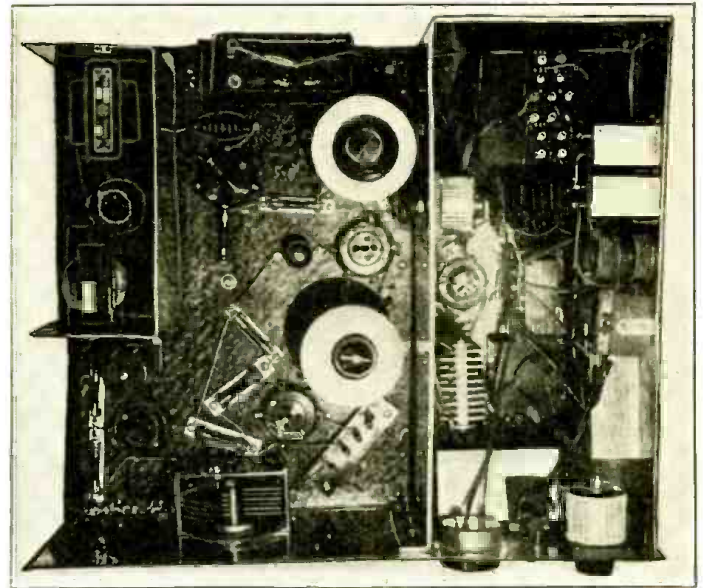

Fig. 3. Top view, at right, of the complete short wave All-Electric Super-Het described in the accompanying article, and prize-winner in recent German contest.

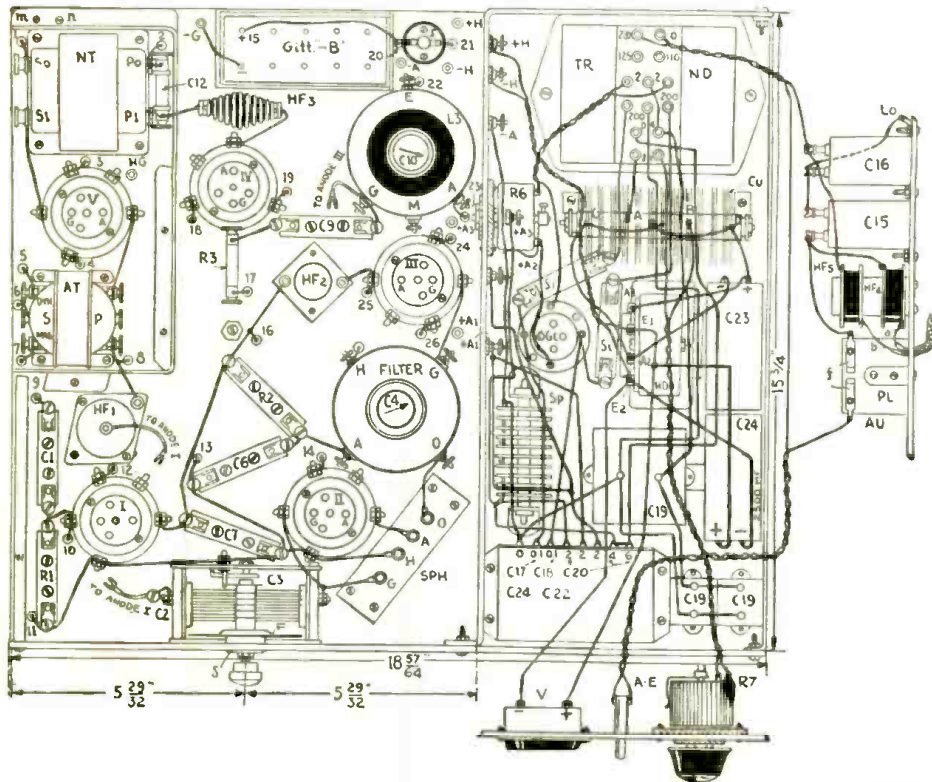
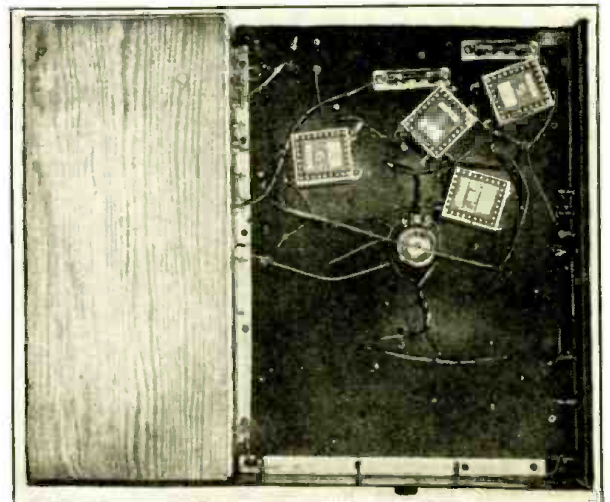

Fig. 2.

Above — General arrangement of parts in power supply unit and short wave super-het of the All-Electric type here described.

Fig. 5.

Right—Under-view of sub-panel of the All-Electric short wave receiver.



HF1, a wire leads to the plate of screen-grid tube 1.

The grid resistor R3 is directly connected at one end to the grid prong of the tube socket of the vacuum tube 4; from the other end a lead runs at 17, through the subpanel to the center connection of the potentiometer P (Fig. 4). The potentiometer is not provided with a knob; but the shaft has a notch for adjustment by means of a screwdriver. The plate of the coil holder SPH lies 0.4-inch above the subpanel. This interval is produced by small insulating tubes through which the four fastening screws of the plate pass.

For retaining the grid battery, a small box of sheet aluminum is fastened on the subpanel; the box is grounded to one of the fastening screws on the under

and the blocking circuit are grounded; the filter shielding has no special ground terminal since the terminal H, which is connected to "—H." (— heater) has metallic contact with the shield can.

For the blocking circuit a special grounding terminal "E" is provided, which is connected through hole 22 to "—H" on the under side of the bottom. Beside the socket of the power tube 5, is an 0.16-inch terminal HG, for connecting the screen-grid (in this German tube, led to a screw on the side of the bakelite base). In the power tube used here, the screen-grid gets the same potential as the plate. If one employs a power tube in which the screen-grid is not connected to a side terminal, but to a fifth prong on the tube, then of course terminal HG is not used; and the middle terminal of the five-prong tube socket V is to be connected accordingly. The fixed condenser C12 is directly connected, suspended by the wiring, with the primary terminal of the audio-frequency transformer NT.

The iron cores and case of the audio-frequency transformer and the input transformer are each grounded on one of the fastening screws (*b* and *c* in Fig. 4). After the wiring is finished, on the upper side of the subpanel, the shielding of the audio-frequency part is at last fastened. It consists of .06-inch aluminum and is

(Continued on page 297)

ECONOMICAL MODULATORS

for
AMATEUR PHONE Transmitters

A common-sense article on modulation, explaining how to obtain the maximum results at the lowest cost.

By C. H. W. NASON

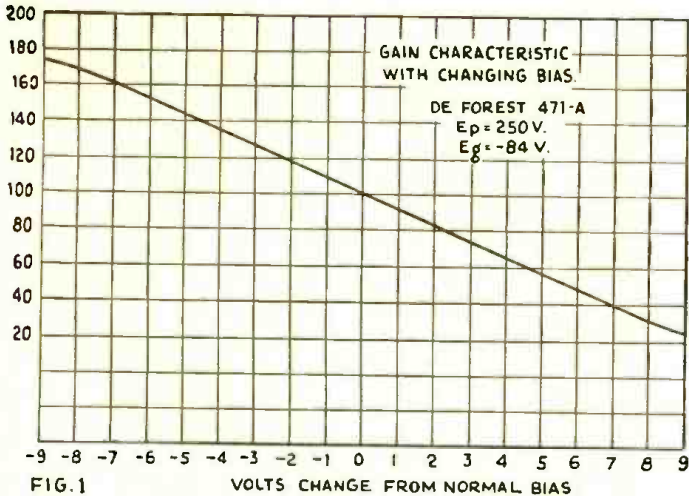

Fig. 1—Chart showing "gain" characteristic with changing bias on a '71-A tube, the normal bias being 84 volts.

NOT long ago the writer discussed in these columns the theoretical aspects of modulation as applied to amateur transmission. While 100% modulation is a desirable feature in any station, there are few now on the air—commercial or otherwise—which can boast of truly 100% modulated waves. As pointed out in the article noted above, the complete modulation of a transmitter requires modulator tubes of no mean proportions; and this is certainly not economical from the standpoint of the amateur whose every penny must count to the best advantage.

What Modulation Is

Concentrated research in the field of television, undertaken by the writer a few months ago, lead him into the subject of modulation to a marked degree; and he retreated from that labor with some valuable information on this and other subjects.

Modulation itself consists of any method of varying the amplitude of a modulated wave. To be sure this variation must be linear, if high quality is to result; and the modulated and modulator tubes must be chosen with care as to their relative characteristics if high standards of operation are to be maintained.

As hinted above, there are few stations which can truly boast of completely-

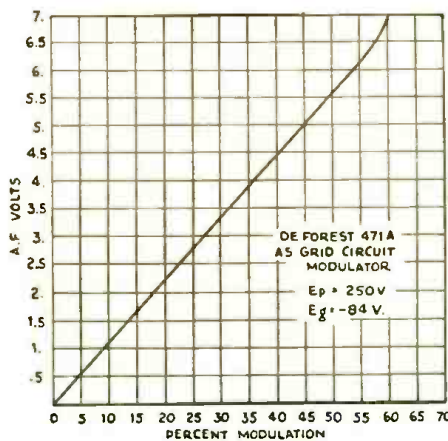

Fig. 2—Graphic representation of action occurring when De Forest 471-A tube is used as a grid circuit modulator.

modulated carrier waves—but inasmuch as the full range of modulation is reserved for rare fortissimo passages, there is no real disadvantage in a percentage of modulation less than 100, provided economy in construction and in operation may be gained. In the transmitter described in the previous article, modulation was achieved by the Heising or constant-current method, wherein the power output of a highly-biased amplifier tube

varies as the square of the applied plate voltage. Of all the potentials to be varied, the plate voltage places the greatest burden on the modulating equipment; and it was with this fact in view that the writer set out to find a simpler and more economical method, which will still give good quality and a fair degree of economy, with respect to the degree to which the carrier is varied under the influence of the voice currents. For reference to the various methods of operating vacuum-tube amplifiers ("Class A," "B" and "C") the reader should investigate the information contained in that previous article which appeared in the April-May issue (page 452) of SHORT WAVE CRAFT.

One of the most effective methods of controlling the volume of a broadcast receiver lies in the use of a variable grid bias on the R.F. amplifier tubes—or, in the case of the screen-grid tube, by vary-

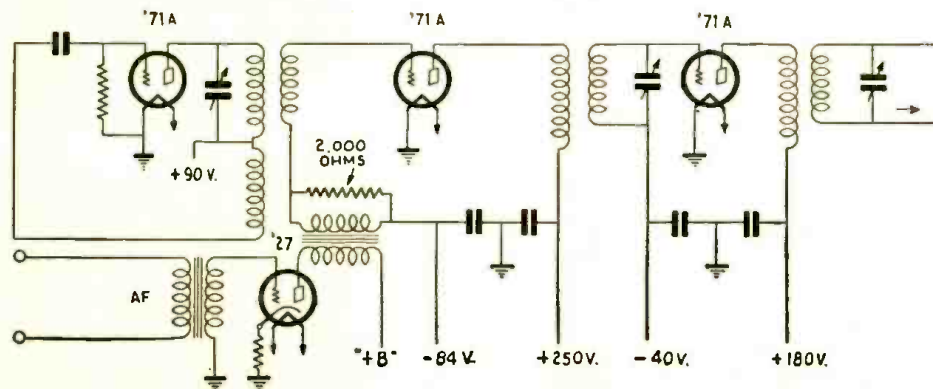

Fig. 3—Schematic diagram of a low-power transmitter, employing economical modulator with a '27 tube, fed by a single-button microphone or phonograph pick-up.

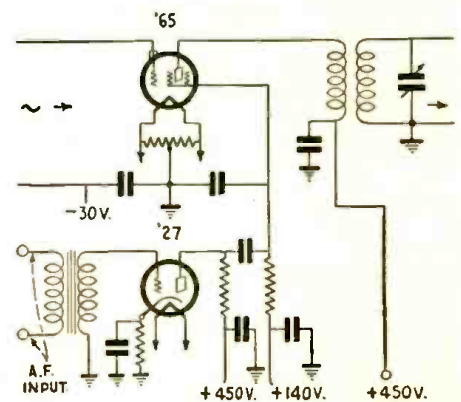

Fig. 4—A more powerful amplifier, using a De Forest 565, 7.5 watt S.G. tube, with '27 tube as modulator.

ing the screen-grid potential. We will describe here two methods of modulation based on this principle and capable of incorporation in small vacuum-tube "transmitters".

A Typical Example

If the grid bias of a '71A tube be varied over a range as shown in Fig. 1, the normal bias being—84 volts, the percent-
(Continued on page 295)

WITH the advent of the new regulations concerning amateur transmitting stations, better and more suitable tests of checking the transmitter were found to be an absolute necessity. Whereas, before, off-frequency was tolerated to a somewhat more or less degree, and raw A.C. notes were taken as a common and necessary evil, such a feeling no longer exists. Today, there must be an adequate filter system for every power supply in use; and off-frequency stations are first warned, and then their licenses are suspended or cancelled. No more does the Radio Inspector look with a broad grin of understanding at any complaints of interference or off-frequency. Today, the axe is applied—and plenty of it, too.

In the check-up of frequency and note transmission, the best practical tests are made with a calibrated wavemeter and a monitor which may or may not be calibrated. Both units are comparatively simple to construct, and must be sturdy to withstand hard service in the shack. The average amateur should experience no difficulty in building these instruments.

In the design of the wavemeter, a large scale coverage is most desirable for any particular frequency range, since it is necessary for accurate calibration and reading. Secondly, to secure accurate dial reading, a vernier dial as large as it is possible to obtain should be used. Thirdly, since the wavemeter must have an indicating device, a suitable bulb must be chosen. The choice lies between neon or flashlight bulbs.

There are advantages and disadvantages of both types of indicating bulbs. Flashlight bulbs below 3.8-volt rating cannot be used, since they burn out too easily. Neon tubes require a certain current before they will light, but are quite sharp in their operation. Flashlight bulbs do not require such a large amount of current, but are very broad in tuning. We believe that neon bulbs are more suitable for this reason alone; besides the fact that they will not burn out as will even the larger flashlight bulbs.

Selecting the Capacity for the Wavemeter

In procuring a variable condenser for the wavemeter, the following facts must be borne in mind: (1) minimum capacity of condenser; (2) capacity spread of condenser; (3) maximum capacity; (4) whether S.L.F. or S.L.C. curve. Since the graph is read in frequency against dial reading, the condenser must be an S.L.F. type if we wish to obtain as nearly a straight line as possible on the graph. In order to get a large dial spread, a condenser having a small capacity change must be used. It is quite obvious that a single condenser cannot be used for all frequencies. On the higher frequencies, a condenser may cover a dial reading of 70 for the complete 14,000-ke. band; while, on the 3,500-ke. band, the same instrument may cover only 200 kc. For the latter band, this

Checking the Short Wave Transmitter

By H. HARRISON

Mr. Harrison, a practical builder of short-wave apparatus, here tells you how to construct a simple wavemeter and monitor.

would be quite inadequate as the band extends over 4000 kc.

The solution is the use of two condensers put in parallel. A 40-mmfd. condenser, shunted by a 25-mmfd. variable, has been found to give about the best all-around results. The minimum

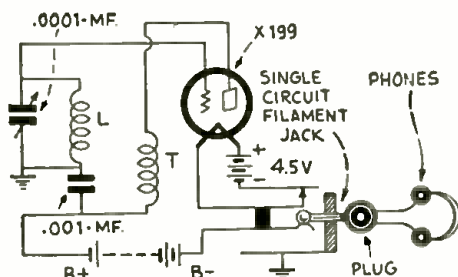

Mr. Harrison's short-wave monitor circuit appears at left; the wavemeter circuit at the right. Mr. Harrison gives his reasons why he prefers neon tubes as "resonance indicators" for wavemeters. For one thing they are sharper than flashlight bulbs for this purpose.

provides a good spread on all the bands. When wiring the wavemeter, make all connections as straight and permanent as possible.

Design of the Monitor Set

The listening monitor is a simple regenerative receiving set as may be gleaned by looking at the schematic diagram. Here the main problem was to design the coils so that the monitor would be as close to the regeneration point as possible, for it is most sensitive to C.W. at this point. The coil chart herewith gives the coil constants for the different frequencies. All coils were wound on tube bases, which simplifies the construction and greatly reduces the cost of building.

A 100-mmfd. variable was found to be suitable for all frequencies; the same large micro-vernier dial is necessary, because tuning is very sharp, and the note can be passed over without the operator being aware of the fact. It is very easy to pass by the note, unless great care is taken when tuning.

The "B" and "A" batteries may be mounted inside the aluminum case which houses the complete unit. A '99 tube is used because of its low current consumption. Some wiring hints may not be amiss. In wiring the single-circuit filament jack, be sure that the phone leads are wired as shown, for otherwise they will be shorted when plugging in.

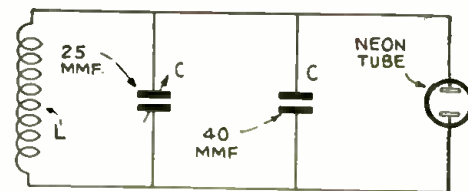

capacity is such that coils may be wound on tube bases. The maximum capacity allows the condensers to be used on all frequencies, and the variable condenser

Parts Required for Wavemeter

- One micro-vernier dial;
- One aluminum case, 6x6x6 inches;
- One UX socket;
- Three UX tube bases;
- One 40-mmfd. fixed con.;
- One 25-mmfd. variable;
- One neon bulb and socket.

Wavemeter Data

Frequency Covered in Kilocycles	Turns on Coil	Dial Spread, Degrees
14,400-14,000	4	15
7,300-7,000	9	25
4,000-3,500	22	55

All coils wound with No. 22 D.S.C. wire on tube bases.

Parts for Monitor

- One micro-vernier dial;
- One aluminum case 5x6x6 inches;
- Two UX sockets;
- Three UX tube bases;
- One 22.5-volt battery;
- One .001-mfd. fixed condenser;
- One .0001-mf. variable condenser;
- One single-circuit filament jack;
- One 4.5-volt battery.

Coil Data for Monitor

Frequency Covered in Kilocycles	Grid Turns	Dial Spread Degrees (App.)	Spacing of Windings
14,400-14,000	4	10	1/2 in.
7,300-7,000	10	14	3/4 in.
4,000-3,500	22	30	1 in.

All coils wound with No. 26 D.S.C. wire on tube bases.

GOOD NEWS!

WITH this issue SHORT WAVE CRAFT has been reduced in price, and the copy now sells for 25c. Instead of 50c as heretofore.

The subscription price has also been reduced from \$3.00 to \$1.50 in the United States, and from \$3.50 to \$1.75 for Canada and foreign countries.

Unexpired subscriptions will be lengthened automatically a sufficient amount to take care of the new price. Thus, if your present subscription would expire in three months, you would get six months automatically, and so on.

And, if you like SHORT WAVE CRAFT, be sure to tell your friends about the NEW PRICE. Be a booster for your "favorite" magazine!

How MANY Microhenrys in THAT COIL?

By JAMES K. CLAPP*

Every radio student should know how to calculate the inductance of a coil of given or known size. Here's a simplified method worked out by a leading engineer.

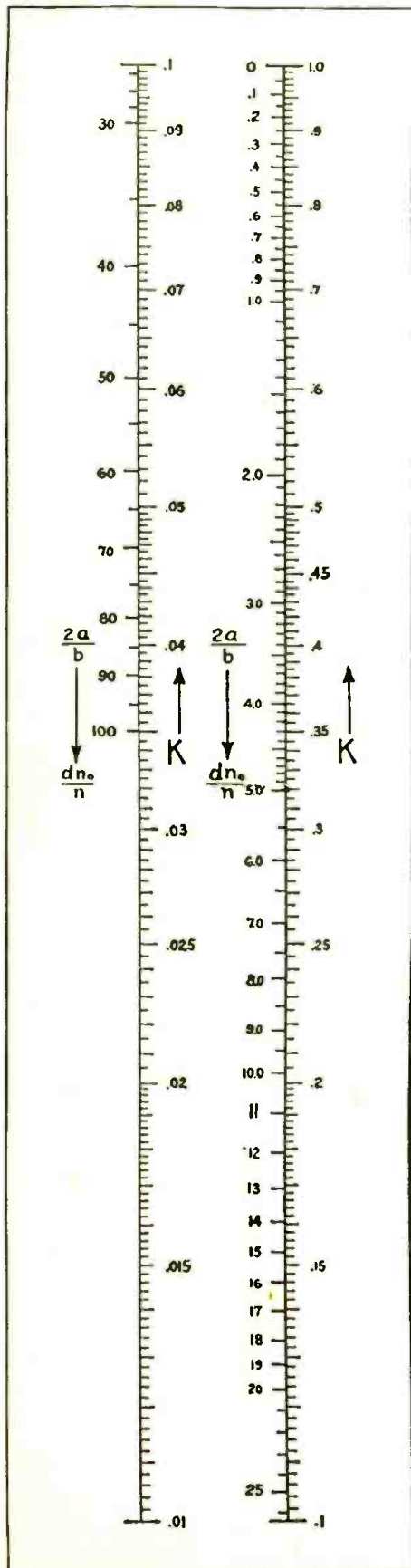
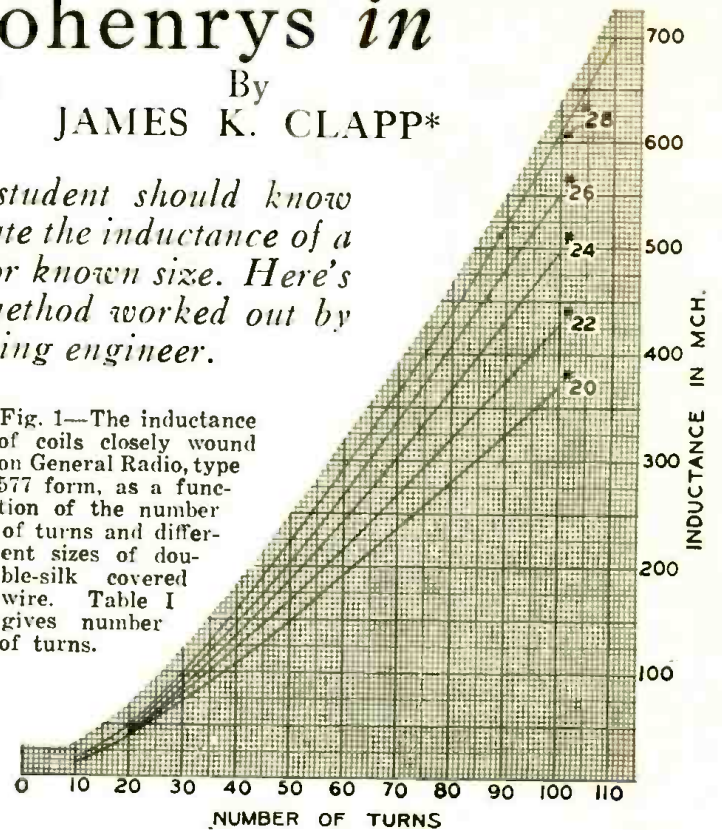

Fig. 3—The graph at left gives the values of Nagaoka's constant "K" for different values of $2a$ over $b = dn_0$ over n , on a logarithmic scale. This chart will prove very useful in calculating the inductance of coils.

Fig. 1—The inductance of coils closely wound on General Radio, type 577 form, as a function of the number of turns and different sizes of double-silk covered wire. Table I gives number of turns.



WHILE much material has been published on the calculation of the inductance of coils,† the formulae given are in general not convenient for engineering use. Two difficulties are encountered in applying the results in engineering practice, one being the involved computations and the other the fact that differences in form and wire sizes and errors in the measurement of these factors introduce errors in the calculations which largely vitiate the utility of precise formulae.

For single-layer coils at radio frequencies (and, with slight modification, for bank-wound coils), Nagaoka's formula probably is the best for general engineering use. While neglecting the shape and size of the cross-section of the wire, the self-capacity of the winding and the variation of inductance due to skin-effect, it may be shown that the formula gives about as good results for high-frequency inductance as can be obtained.

Tables of the values of Nagaoka's correction factor have been prepared, but require considerable time to use due to the necessity for interpolations. The table values may be plotted in the form of a curve, but a more convenient interpolation is made possible by plotting these values on logarithmic scales, as has been done in Figure 3. Where much work of this type is done, the scales may be transferred to a slide-rule so that no reference to printed material is required.

The formulae given here, when carefully applied, give values of inductance

to within about two per cent. for single-layer coils and to within about five per cent. for four-layer bank-wound coils for frequencies where the coils would serve as normal tuned-circuit elements.

The general formula is

$$L = \frac{0.1003a^2n^2K}{b}, \text{ microhenrys (1)}$$

where a is radius of a mean turn in inches, n is the number of turns, b is the length of the winding in inches, and K is Nagaoka's correction factor which is a

function of $\left(\frac{2a}{b}\right)$ or the ratio of diameter to length of the winding.

If n_0 is the number of turns per inch, the inductance and ratio of diameter to length are more conveniently given by:

$$L = 0.1003a^2nn_0K, \text{ microhenrys (2)}$$

$$\text{or } L = 0.0251d^2nn_0K, \text{ microhenrys (3)}$$

$$\text{where } \frac{2a}{b} = \frac{2an_0}{n} = \frac{dn_0}{n} \text{ numeric (4)}$$

and d is the diameter of the mean turn in inches.

Given the size of wire and its insulation and the diameter of the coil form, n_0 as wound, is found from Table I and

$\frac{dn_0}{n}$ is readily computed for any desired

number of turns. Read the corresponding value of K from the scales at the left. The inductance is then easily computed by means of the slide-rule.

* Engineer, General Radio Company.

† See in particular the publications of the U. S. Bureau of Standards and the Proceedings of the Institute of Radio Engineers.

For banked windings of not too great depth as compared with the diameter, a close approximation for the inductance is obtained by using Nn_0 for the turns per inch (where N is the number of banks) and $\frac{dNn_0}{n}$ for the ratio of diameter to length.

Then $\frac{2a}{b} = \frac{dNn_0}{n}$ numeric (5)
 and $L = 0.0251d^2Nnn_0K$, microhenrys (6)

The number of turns required for a desired value of inductance cannot be directly calculated since K varies as n is varied. With given types of windings experience will indicate an approximate value for the number of turns. If the computations are carried out and the inductance obtained is near the desired value, the correct number of turns to give the desired value may be obtained by readjustment, since K does not vary rapidly with n . Where many values are required it is simpler to calculate a sufficient number of values for a curve. The required values may then be read off directly. (See Figures 1 and 2, for example.)

EXAMPLES OF CALCULATIONS

Given: Form diameter = 2.75 inches (General Radio Company Type 577 Form). Wire size = No. 20 double-silk-covered. Find: The inductance for coil of 35 turns.

Procedure: In Table 1 find $n_0 = 25$

$$\frac{dn_0}{n} = \frac{\left(2.75 + \frac{1}{25}\right)25}{35} = 1.99$$

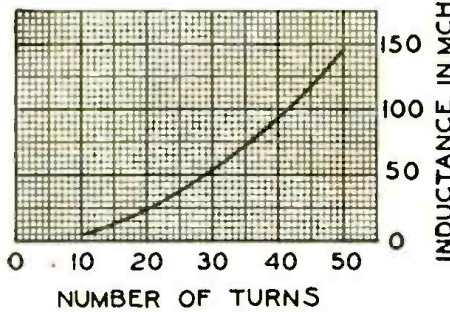

Fig. 2—Inductance of coils wound on General Radio, type 577 form, with double silk covered, copper wire, in which the turns have been equally spaced in order to fill the 2-inch winding space. Here $n_0 = \frac{1}{2} n$.

TABLE I
WINDING DATA FOR CLOSELY WOUND COILS

SIZE OF WIRE B & S	TURNS PER INCH				TOTAL TURNS FOR FULL 2-INCH FORM
	Single		Double		
	Enamel	Silk	Silk	Cotton	
20	29	27	25	27	50
22	30	34	30.5	34	61
24	45	43	38	41	76
26	57	52	45	50	90
28	71	64	53	60	106
30	88	80	66	71	132
32	120	95	76	84	152

From scales, opposite 1.99 for $\frac{dn_0}{n}$, read $K = 0.526$
 $L = 0.0251 \times (2.79)^2 \times 35 \times 25 \times 0.526 = 90.0$ microhenrys.

For a rough estimate, the diameter of the form may often be taken as the diameter of a turn. In the above example this procedure gives $\frac{dn_0}{n} = 1.965$,

$K = 0.530$ and $L = 88$ microhenrys, which differs from the previous value by about 2.5 per cent.

For bank-wound coils an example is as follows:

Given: $d = 2.75$, $n_0 = 25$, $N = 4$, and $n = 200$

$$\text{Then, } \frac{dNn_0}{n} = \frac{\left(2.75 + \frac{4}{25}\right)25 \times 4}{200} = 1.455.$$

From Figure 3, $K = 0.604$

Then $L = 0.0251 \times \left(2.75 + \frac{4}{25}\right)^2 \times 4 \times 25 \times 200 \times 0.604 = 2570$ microhenrys.

Many experimenters and many engineers "design" inductors by guessing at the number of turns, then peeling off wire until the correct value of inductance is obtained rather than go to the trouble of using the usual tables and formulas. Our experience with the method described here proves conclusively that much time and effort are saved by calculating the desired value of inductance before the coil is wound.—*Courtesy "General Radio Experimenter."*

How to Cure "Dead Spots" in Receivers

By Mander Barnett

NOTHING can be more annoying in a short-wave receiver than to find that the set refuses to operate at certain points of the tuning dial. Receivers of the type which use either a tuned or an untuned stage of R.F. amplification in front of the detector are not so liable to suffer from this defect as the plain regenerative receivers. Even here, however, the trouble is liable to occur to some degree, and is due to a number of causes which may be classed as being either mechanical or electrical.

In the former class we may place, for instance, a faulty tuning condenser, the plates of which short at certain points on the dial. Again, perhaps, some portion of the circuit was wired rather hurriedly and consequently, may be shorting somewhere; perhaps against the metal cabinet, if one is used. Condensers which use bare metal pigtailed should be used with great caution in short-wave tuners. The turns of the pigtail are liable to catch and will cause bad crackling; and, possibly, render the condenser inoperative at certain points of the dial. In cases like this, it is best to scrap the condenser and use some other type, in which a different form of positive connection is made. Condensers which use a covered pigtail are, of

course, quite O.K. for the job. Apart from other obvious mechanical defects in condensers, coils, tube sockets, etc., there are not many other directions in which trouble of this sort is to be found.

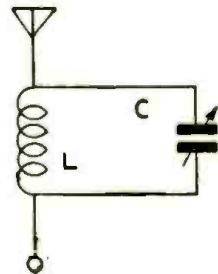

Fig. 1, at left, shows tunable circuit, placed in series with antenna for purpose of eliminating "dead spots."

The next section under discussion, i.e., electrical causes, contains a large number of causes which may bring about these "dead spots". In short-wave tuners of the usual regenerative type, the most usual culprit is the antenna itself. When the receiver is tuned to the natural wavelength of the antenna, an absorption effect occurs and the set refuses to oscillate. It is not generally realized, however, that this effect can be easily got over by tuning the antenna itself,

and thus placing the natural wavelength far out of the reach of the tuning dial. This can be done as shown in Fig. 1.

The coil L may consist of six turns of fairly thick wire, such as No. 18 or 20 cotton-covered wire, wound on a form about 1 inch wide (an ordinary tube base will do—here is yet another use for the overworked tube-base!). The condenser C may be of any of the usual capacities, the .0005 mf. broadcast model will do quite well; or, better still, use one of the small compact adjustable condensers which are set to the correct value by means of a small screw on top of the case. If a metal cabinet is used, the coil and condenser should be placed inside the cabinet, if there is sufficient room.

The procedure for tuning out the dead spot is very simple. First of all, tune in the dead spot with the antenna connected in the usual manner; then connect the coil and condenser in circuit and adjust the condenser until the dead spot moves off the dial. It will, of course, appear again on some other wavelength; but it can be tuned right out of the usual short wavelengths.

Well, so much for one cause. The next most frequent culprit is the R.F. choke
 (Continued on page 298)

The PROPAGATION of SHORT WAVES

By ROBERT MEYER,
(Hamburg, Germany)

The author describes his new theory of the effect of cosmic energy and change of season on the transmission and reception of short waves. The solar radiation of electrons in their effect on short waves is discussed.

IN the last few years, many radio listeners have tried to change over to the reception of short waves. much success has been attained but the interest in general waned very soon; because in the short-wave field there are peculiar propagation conditions which, so far, have not been understood in their basic principle. Even the set owner who

earth (the side away from the sun). The curve must always have the same form, since the two effective components (velocity and attraction) do not change their relation. If, nevertheless, the distance traversed by the electrons varies according to the time of day, then an important factor must have remained hitherto unconsidered.

is the distortion in the case of the reflection umbrella formed in the evening twilight. There the northerly-directed branch is so expanded that it does not touch the earth again; therefore this line of propagation is useless for practi-

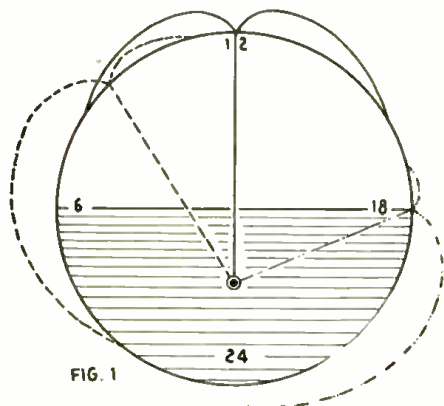

Fig. 1—Daily range-displacement of short waves.

It has been recognized, since Newton, that the reciprocal action of two bodies in space does not take place in the true centers of the bodies, but lies eccentrically according to the respective strengths of the bodies. From the reconstruction of many observed zones of reception, I now found the ideal or specific center of terrestrial attraction displaced about half the earth's radius or 1,980 miles, toward the north magnetic pole. The position of this center of attraction may be seen in Fig. 1; and from this diagram there also becomes clear its significance for the determination of reception zones.

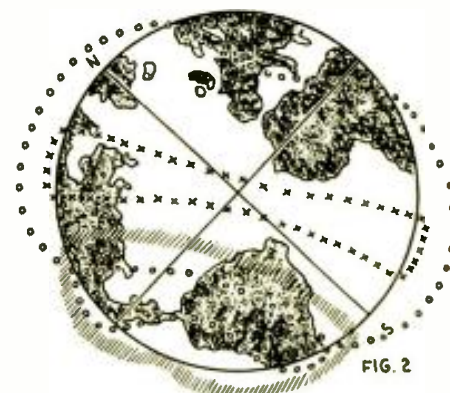

Fig. 2—Short wave lines of conduction over the earth in summer.

is well up in the working conditions on the well-known broadcast wavebands, is confronted by puzzles in the case of the bands which have been investigated but little.

It is a well-known fact that the working conditions or ranges of all the bands change once in the period of a day; but that this change is considerably modified by the season of the year. This observation led the writer to formulate the idea that the emission of the short-wave transmitter is something secondary; the influencing or modulation of a cosmic energy being probable. With this assumption, it becomes clear that even a nearby transmitter must remain inaudible, unless a flow of this cosmic energy is present between the sender and the receiver.

Now it is natural that we should, in view of the cosmic dependence of the earth on the sun, take into account the solar radiation of electrons, to explain the formation of lines of conductivity for short-wave transmitters. The solar electrons strike the earth and are partially reflected; after reflection, they must describe a curve which is determined by their own velocity and the attraction of the earth. Fundamentally, therefore, the reflected electrons must describe a path, through the atmosphere, from the point of rebound to the "night side" of the

The reflection curves of the solar electrons are represented for three different hours of the day. With vertically falling sunbeams, at 12 (noon), there is formed a symmetrical "umbrella" of conductive lines; for the imaginary axis of the reflection path passes through both the center of the earth and also through the theoretical center of attraction. The range formed at about 10 o'clock is unsymmetrical; the branch pointing to the south is shortened, and the effective path to the north is lengthened. Still greater

cal communication. In both cases the influence of the ideal center of terrestrial attraction is plainly recognizable. Practical experience is accordingly confirmed and explained by the writer's theory.

According to this assumption, there hangs over the earth on the day side, a multiple "umbrella," which contains, besides the lines shown, all the intermediate stages. At the same time there is a possibility of communication between any two places on the surface of the earth, which are touched by the same line of conductivity. The lines themselves are given continuous excitation from solar electrons.

In the course of a day, in view of the rotation of the earth, each point on the surface of the earth describes a fixed path in this "umbrella" structure, and finds operating conditions periodically changing. Besides the daily revolution, the earth annually completes a circuit about the sun; whereby there is caused a constantly changing angular inclination of the earth's axis to the sun. This second motion of the earth in the cosmically-located network of conductive lines (which are therefore fixed in space) is the cause of the changes in range which occur during annual periods, as may be seen from Figs. 2 and 3.

The ranges indicated in Fig. 1 may again be recognized over the earth, which
(Continued on page 298)

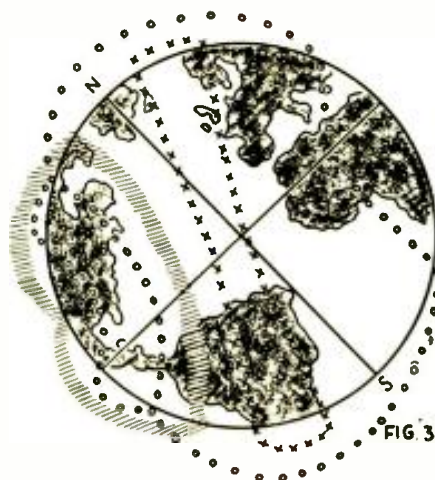

Fig. 3—Short wave lines of conduction in winter.

The New PILOT ALL-WAVE RECEIVER

By R. F. SHEA and EDGAR MESSING

The new "All-Wave" receiver covers a range of 10 to 550 meters, the set using eleven tubes in a double superheterodyne of high sensitivity and selectivity, with good tone quality. Has a wave change switch.



Above: The new Pilot "All-Wave" super-het with "wave change" switch. Range 10 to 550 meters.

Left: Rear view of "All-Wave" super-het, showing dynamic speaker.

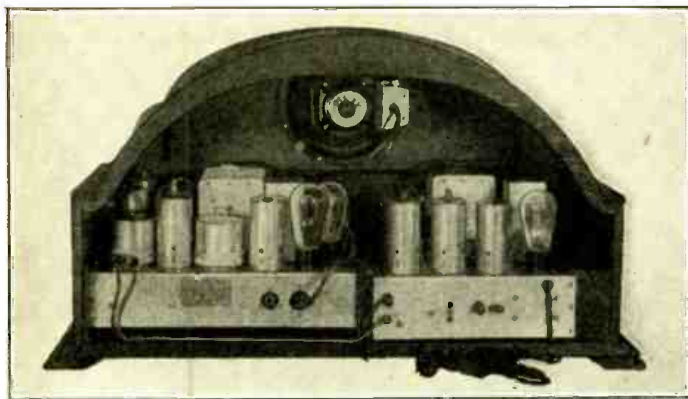

its three predecessors. This is the new Pilot "All-Wave," an eleven-tube double super-heterodyne that has features of design and construction that were undreamed of only a year ago.

FROM the same laboratory that produced the Wasp, the Super-Wasp and the Universal Super-Wasp, there now emerges another short-wave receiver that promises to eclipse the world-wide fame achieved by

Covering a wavelength range from 10 to 550 meters at the turn of a knob, the "All-Wave" is a real combination receiver. Previous combination-wave sets were primarily short-wave receptors, and only incidentally broadcast receivers.

They brought in the stations on the 200-550 meter band fairly well, but in this regard they admittedly were inferior to standard broadcast instruments. The new "All-Wave" does not suffer from this shortcoming. On the broadcast range it is an honest-to-goodness superheterodyne of the latest design; in fact, it uses the regular seven-tube chassis and dynamic loudspeaker of the new Pilot Midget, model No. S-148.

For the short-waves, a separate four-tube superheterodyne converter unit is brought into action. This feeds into the seven-tube unit, which is adjusted to 550 kc. and left there. The tremendous amplification of this chassis is brought into full use for short-wave reception, the set being employed as an intermediate-frequency amplifier at this frequency. This arrangement was devised for technical reasons, and not merely for mechanical convenience. The reason is that the optimum intermediate frequency for 200-550 meter operation is quite different

(Continued on page 296)

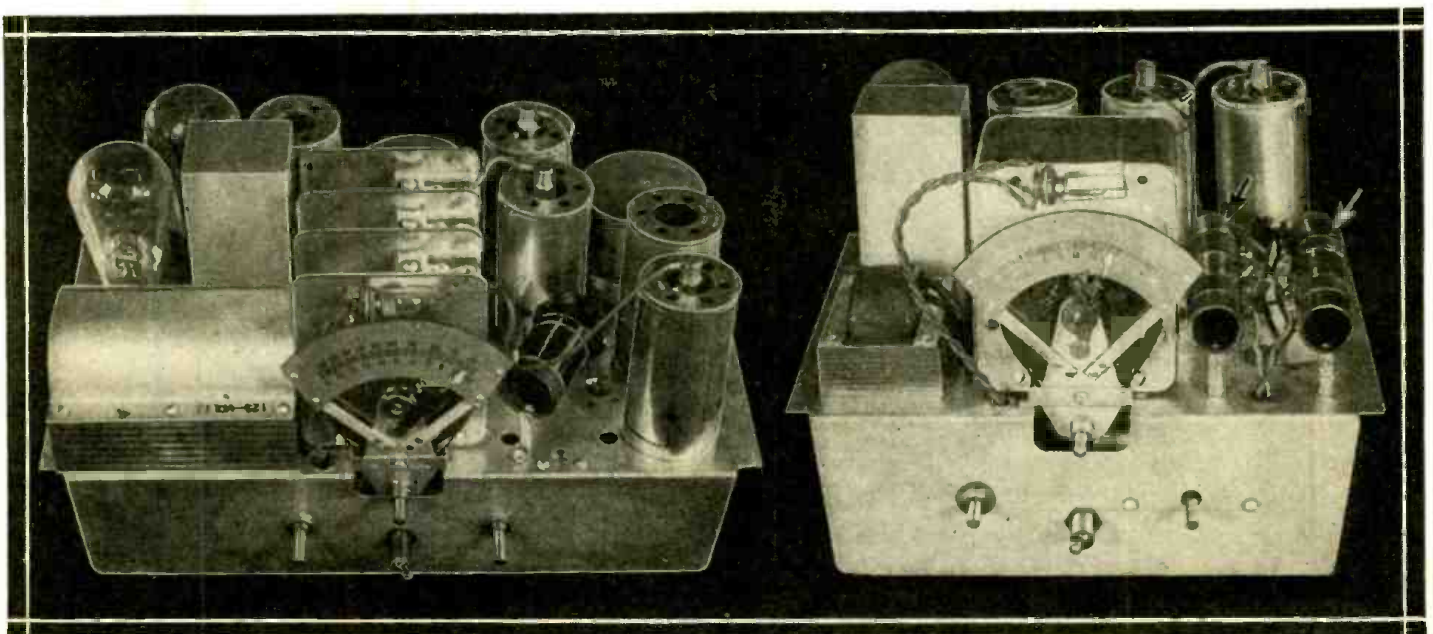

Broadcast chassis on left; short wave chassis at right. Arrows point to short wave coils—switch is directly below.

The New Tanner Audio System

ABOUT a year ago, while experimenting with short-wave receivers, it was found that audio howling and motorboating are far more serious than in regular broadcast sets, especially

would be of equal magnitude when C equals C1. The potential at the mid-tap of the two capacities would then be zero, with respect to the preceding grid. Feedback to the grid will occur; positive

spectrum. The resistance R is employed for the purpose of reducing the magnitude of the peak frequency to a satisfactory value.

The voltage step-up is:

$$\text{Voltage step-up} = \frac{C + C1}{C}$$

By making C1 variable in steps (the minimum capacity should not be smaller than C) with a variable resistor at R, it is possible to peak an amplifier to suit the ear of the individual or to overcome any deficiencies in a loud speaker.

In Fig. 2 is a circuit for a two-stage Tanner audio amplifier for use with either a radio set or a magnetic pickup. The values for C1 and R may be fixed in the first stage, for simplicity, and variable in the second. In practice, the variables are adjusted when the amplifier is installed, and then they are left alone.

While this system was developed mainly for use in short-wave receivers, it may readily be employed wherever an audio amplifier is required, with greatly improved results.

The public is fast becoming tone-conscious. Some prefer a rising characteristic on the "lows," and some on the "highs." The Tanner system will give the listeners what they desire.

These audio transformers will soon be available on the market, as well as factory built amplifiers and kits of parts.

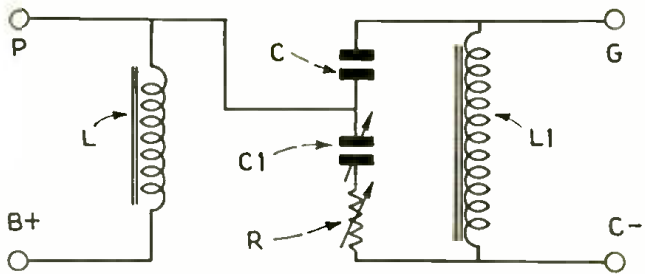

Fig. 1. New audio coupling transformer which eliminates howling and motorboating. The value of impedance L is dependent upon the type tube used. L1 is the grid impedance coil.

when operated from "B" battery substitutes. With transformer- or impedance-coupled audio amplifiers, these noises could generally be eliminated by shunting the grid of the first A. F. tube with a resistor under 100,000 ohms, or, in the case of resistance coupling, by reducing the resistance of the first A. F. grid leak to the same value. This is a very inefficient method, in view of the fact that most of the higher frequencies are shunted to ground, as well as of the large reduction in gain.

It was finally decided that a new system of amplifying the output of the detector, which would be practically free from howling and motorboating, was needed. Considerable research resulted in a new type of audio coupling transformer, details of which are given in Fig. 1.

The "B+" is led to the plate through an impedance L, the value of which depends upon the tube used; this may be replaced with a resistor, which is to be preferred in the case of a detector. L1 is the grid impedance coil. It will be observed that the plate tap is made at the juncture of two capacities connected in series across L1. If the resistance of L1 were zero, the potentials across C and C1 would be opposite in phase; in which case these opposite potentials

when C exceeds C1 and negative when C1 exceeds C. It is apparent, then, that by making C1 somewhat the larger of the two, audio howling, due to unavoidable magnetic coupling, may be compensated for.

As C and C1 are in series, the effective capacity across L1 is:

$$\text{Effective capacity} = \frac{1}{\frac{1}{C} + \frac{1}{C1}}$$

By properly proportioning C, C1 and L1, a rising characteristic may be obtained at any frequency within the audio

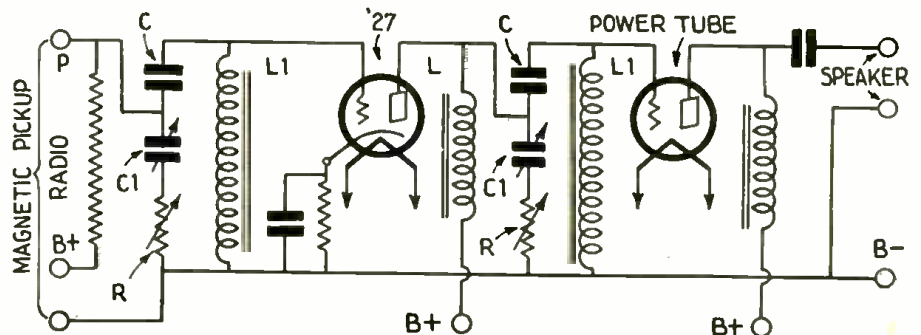

Fig. 2. Circuit of new Tanner audio amplifier with 2 stages, suitable for use with radio set or phonograph pick-up.

Enhanced Audio Amplification

MANY experimenters have found that, generally speaking, two audio stages in a short wave receiver create too much noise of a "mush" type for weak, long-distance signals. There is a very simple way to get over this, by means of auto-

transformer coupling; and if this is arranged for parallel-plate feed, the heavy D.C. of the "B" battery is kept out of the loud speaker (or phones, as the case may be).

Fig. 1 is the conventional layout for

a single transformer-coupled audio stage, while Fig. 2 is the suggested layout to obtain greater amplification from one audio transformer, which can, with advantage, be of high (7:1) ratio.

(Continued on page 298)

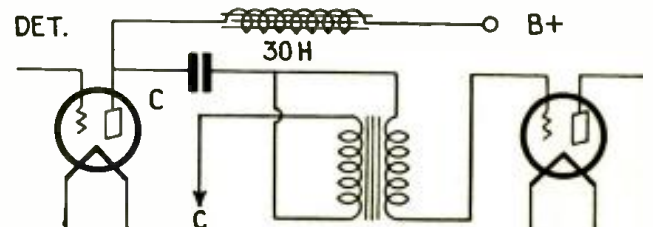
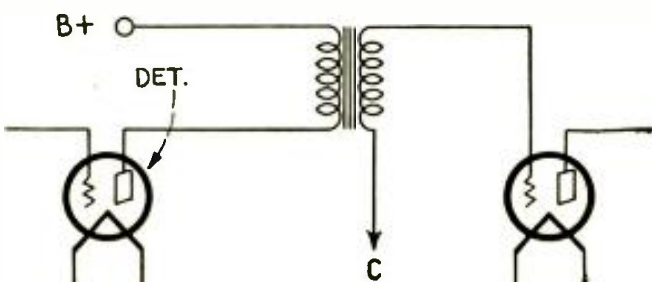

Fig. 1, at left, shows conventional hook-up of detector to audio stage; Fig. 2, above, improved auto-transformer hook-up, which eliminates "mushy" tone.

THAT'S WHAT THEY ALL SAY

Editor, SHORT WAVE CRAFT:

I have been a constant reader of your magazine ever since the first one was published. I think it is the ideal magazine for an amateur. I would appreciate an article on Monitors, as all stations need them.

I would appreciate it if you would publish this as I would like to hear from other Short Wave Fans; I will answer all mail.

Yours wld 73s,
F. M. WENTZ,
Amateur Radio W8EEQ,
211 Larkins St.,
Findlay, Ohio.
(Official Relay Station.)

(All right F. M. we take you at your word and remember that we have it in writing that you will answer "all" mail. The very first complaint we get that you have failed to answer each one, to the last word, we will promptly report you to the black-ball committee and your frequency will not be so "hot" hereafter. But we know that will not happen because real amateurs keep their word at all times. More power to you.—Editor.)

WHAT SAY, BOYS?

Editor, SHORT WAVE CRAFT:

This is to compliment you on your publication, SHORT WAVE CRAFT, and at the same time to offer my sincere suggestions as to a definite department that might be included in its pages.

Almost everything that the amateur, ham, et al, can wish for is included in your publication, save for one thing, which, in my opinion, would be a help to all concerned.

This "missing" item is that of a department in which some reliable amateur, engineer, or the like, publish his notes on short wave reception from day to day, or week to week, commenting on the kind of programs received, variety, signal conditions as to strength, etc.

These notes would be valuable to the amateur who has just started out, as well as to the "hard boiled," who could check their own reception from time to time. Of course there is a maze of stations, but these notes need only be on the more reliable sources of reception, so that a definite period may be set aside from day to day by amateurs who are eternally raking the "Heavside" in the hope of hooking that elusive signal or signals, with very little idea whether or not the signals are there.

I own a battery model Super Wasp, and get plenty of practice with it, but too often reach out to bring in the signals that aren't there. Correspondence with anyone owning a Super Wasp is respectfully solicited. I will gladly answer all letters.

Radioally yours,
JOSEPH C. COLLINS,
1805 Breckenridge Ave.,
Austin, Texas.

(It is not a bad idea, Joe, but we really would like to put it up to the readers and if they want such a department, we will "shoot the works." It is easy enough to do it and the editor, as he has told you before, doesn't give a "rop" what he prints as long as he pleases you readers. But from the technical viewpoint, is such a department really worthwhile? The short wave enthusiast knows what is a good antenna circuit, and what is a good antenna circuit in one locality is a total "flop" in another. Have you thought of it in that way?—Editor.)

CHEERIO! O! O!

Editor, SHORT WAVE CRAFT:

I am a 100% reader of SHORT WAVE CRAFT and have gotten ten copies up to date. This magazine is the most interesting of all I have ever read. If you want to know anything about short waves, read SHORT WAVE CRAFT, to get new ideas. I am as proud of the SHORT WAVE CRAFT as I am of my seven-year-old Robert's three tube set. I hold a record of 3,800 miles one stretch. Alaska, California, Mexico, Alberta, as "runners up". Now I am in the short-wave class. I built a three tube, short-wave set of my own design, with 50% of help from SHORT WAVE CRAFT.

This set is at present one and one-half months old, holding the following record: Loud speaker reception every day—not luck—but

every day occurrence. I have heard the following stations: FZG, Saigon, Indo-China every Friday, daylight saving time, at 7:30 P.M. to 8:00 on 24.85 meters. G5SW, XDA, W9XE, 7LO-9frica, HRB, VE9CL, W8NK, W2XE, VE9GW, WAXM, W2SB, XFA, WGSY, WKBF, Minn KFKP, WEEB, Baltimore.

Please note every station is daily received except 7LO and FZG. I have only finished my low wave band; I mean it took me about two weeks to bring my set down to 6 meters. My

AMONG THE HAMS

set will now tune from 6 to 199 meters with 100% oscillation—no dead spots on this set. When I have perfected this set, I will send it to you so that some ham who has not had the pleasure of hearing Africa or England, can do so. We hear G5SW every evening, except Saturday and Sunday, signing off at 12, ringing Big Ben. We heard it every evening last week (week of May 10th), rain or shine. Again I say, Cheerio, to the SHORT WAVE CRAFT and to our good old friend the editor. I will answer all "hams". I have verified reception from XDA, HRB, VE9CL, G5SW, XFA. Yet to come from 7LO and FZG. I would like to build sets if I had prospective customers.

I wish to say to the radio hams of SHORT WAVE CRAFT that I can pick up G5SW, Chelmsford; VOR2, Austria; FZG, Saigon; FTN, Paris; 12R0, Rome; XDA, Mexico; WE9CL, Winn., on the loud speaker! No aerial, three tube receiver. Can be heard 40 feet from speaker.

What do I use in my aerial circuit? With an aerial, reception only 30% better. If I can receive 15 clippings with this on it, I will give the circuit and aerial circuit to the SHORT WAVE CRAFT, so that you may know the secret of how it's done. That's fair enough. I also wish to say that I have heard G5SW, twenty days in four weeks; that is five days a week. VOR2, Austria, seven days a week. I received my G5SW card. Weather conditions have no effect on this receiver. I pulled in Austria with no aerial on loud speaker, thermometer at 86° in the shade. If you want to know how good your receiver is on 25 meters, try between 5:30 to 7:00 P.M. to listen to G5SW as they sign off at 7:00, when they ring "Big Ben". SHORT WAVE CRAFT is 100% perfect. I have at present 14 copies and it's the only short wave magazine in my home; no other will do. I am very fussy about what magazine I read.

Cheerio,
OLIVER OMLIE,
56th City Line,
Overbrook, Phila., Pa.

P. S.:—I have only built radio seven years. I have a three tube receiver, long wave. Record—Alaska, California—this is one of my own make.

(This looks like good work to us, Oliver, particularly when you mention the seven year old Robert three tube set. It seems it is still a good circuit and your results would seem to justify it. You might send us some details of the hook-up for publication purposes. Good luck to you.)

If we do not miss our guess, Oliver, we know you will be snowed under with letters and you are more apt to get 1,500 than 15. It serves you right and cheerio to yourself—Editor.)

ETHER FRICASSEE

SHORT WAVE CRAFT is certainly up to the standard of all the publications that you have ever had anything to do with.

I would like to see the readers of SHORT WAVE CRAFT join hands to see whether some-

thing cannot be done about the interference of W3XAL with VE9GW. Both are good stations and deserve to be heard without interference. My suggestion is this, the National Broadcasting Co. does not seem to be operating W9XE, since they took over WENR. Why not operate W3XAL on 6020 kilocycles?

In the past week (prior to March 30th) I have noticed several changes in the frequencies on which the ship-to-shore and trans-Atlantic stations are operating on. It ought to be easy for you to obtain these changes from the headquarters of these stations in New York. WND was working on 9,170 kilocycles yesterday afternoon, according to their own announcement of it when they signed off. WSBN was working on 4,175 kilocycles last evening. The stations at Rugby, England, have also changed some. Let us have the latest dope on them.

At 11:45 A. M. yesterday I picked up a strong carrier wave a little above 12,045 kilocycles, and at about 12:08 P. M. when they started to talk it was GBS. However, almost as soon as they started talking the signals and the carrier wave started to swing but before they started to talk everything had remained perfectly steady. GBU and GBW were hooked in the same circuit but the reception from them was worse than GBS.

My theory is that poor modulation causes a large part of the swinging so common to short wave stations. I receive VE9GW with no noticeable swinging although many of the stations that I hear are twice or three times as strong, they are all subject to more or less swinging.

Last night the operator at WOO, had the operator of WSBN busy trying to get a better signal into New York City, the operator on the shore told WSBN that their signals were so poor that they would be unable to put through a couple of commercial calls, that they had for the ship. WSBN's operator was adjusting and testing from 9 until 10 P. M. last night, and at the end of that time gave up trying. I don't think I missed understanding more than a dozen words of WSBN's operator all during the test, but the operator at WOO claimed that the signals were too poor to put through the calls. Maybe I could get a job building a good receiver for WOO?? My receiver uses 3 UY 224's and 1 UY 227. When I want to operate a loud speaker, I put the signals through the A.F. amplifier of my broadcast set and into the speaker.

The articles in SHORT WAVE CRAFT are fine. You may be sure that they are read and re-read by me. While it may be possible that your magazine does not have a universal appeal to all short wave fans, nevertheless I do not see how an experimenter like myself can do without it.

I have never been lured to take any correspondence courses in radio. Although I have several good books on the theory of radio and secured no end of practical knowledge through experimenting and information gleaned from reading Gerusback publications. I am pretty sure that I know more about radio theory and practice, than at least half of these learn-by-mail graduates.

I don't know where I have ever ran across more real facts and less fancy than in RADIO-CRAFT. Although I am familiar with those who have been associated with you in publishing your magazines since 1922, you have never to my knowledge been surrounded with a more capable staff than at the present.

You keep up the good work in publishing these magazines and I'll keep on talking up your publications so that your subscription lists will continue to grow.

Yours sincerely,
CARROLL C. FOLTZ,
303 Central Avenue,
North Baltimore, Ohio,

(We fully agree with you, Carroll. This ether frequency and wave "hash" is getting pretty tough. We know exactly how you feel as every once in a while we ourselves blow up behind the loud speaker and become pretty much peeved. It would be a good idea to write to those stations which you think are the offending ones and tell them of the adverse results you are getting. It would seem to us that sooner or later this should bear good results.—Editor.)

Short-Wave Stations of the World

Meters	Kilo-Cycles	Station Name	Location	Notes
5.00	60,000	W10XAY	portable	Licensed to 0.71-meter, 401,000 kc. Pollin, Inc., New York.
4.97-5.35	60,000-56,000	Amateur	Telephony and Television.	
5.88	51,100	W2XBC	New Brunswick, N. J.	
6.89	43,300	W9KD	Milwaukee, Wis.	Television. Milwaukee Journal.
		W3KAD	Camden, N. J.	Television. (Other experimental television permits: 48,500 to 50,300 k.c., 43,000-18,000 k.c.)
		W1XG	Boston, Mass.	
		W2XBT	New York	
7.05	42,530		Berlin, Germany	Tu. and Thu., 11:30-1:30 p.m. Telefunken Co.
7.32	41,000	W8X1	East Pittsburgh, Penna.	
7.58	39,560	PCJ	Hilversum, Holland.	
7.85	38,220		Eindhoven, Holland.	
			Amsterdam, Holland.	N. V. Philips
				4-7 p.m. Saturdays.
8.67	31,600	W2XBC	New Brunswick, N. J.	
9.68	31,000	W8X1	Pittsburgh, Pa.	
9.93	30,200	W6KD	M. R. T. Co.	
9.96	30,105		Golfo Aranci, Sardinia.	Telephone to Rome.
10.51	29,190	PK313	Sourabaya, Java	Wed. and Sat., 5:50-7:50 a.m.
10.79	27,800	W6KD	Palo Alto, Calif.	M. R. T. Co.
11.35	25,960	G5SW	Chelmsford, England	Experimental.
11.67	25,700	W2XBC	New Brunswick, N. J.	
		W3XA	Philadelphia, Pa.	Norden-Hauck El. Mfg. Co.
12.48	21,000	W6AQ	San Mateo, Calif.	(Several experimental stations are authorized to operate on non-exclusive waves of a series, both above this and down to 4 meters.)
			Vienne, Austria	Mo., Wed., Sat.
13.04	23,000	W2XAW	Schenectady, N. Y.	
13.92	21,540	W8XK	Pittsburgh, Pa.	
13.97	21,469	W2XAL	New York	
13.99	21,429	XFA	Mexico City, Mex.	(Authorized to broadcast at any higher frequency.)
14.00	21,420	W2XDJ	Deal, N. J.	And other experimental stations.
14.01	21,400	WLO	Lawrence, N. J.	transatlantic phone.
14.15	21,130	LSM	Monte Grande, Argentina.	
		W2XAO	New Brunswick, N. J.	
14.27	21,020	LSM	(Hurlingham), Buenos Aires, Argentina.	
14.28	21,000	OKI	Podebrady, Czechoslovakia.	
14.47	20,710	LSV	Monte Grande, Argentina.	Telephony.
14.50	20,680	LSM	Monte Grande, Argentina	after 10:30 p. m. Telephony with Europe.
		LSX	Buenos Aires	Telephony with U. S.
		FMB	Tamatave, Madagascar.	
		FSR	Paris-Saigon	phone.
14.54	20,620	PMB	Bandonk, Java	After 4 a.m.
14.62	20,500	W9XF	Chicago, Ill.	(WENR).
14.89	20,140	DWG	Nauen, Germany	Tests 10 a.m.—3 p.m.
15.03	19,950	LSG	Monte Grande, Argentina	From 7 a.m. to 1 p.m. Telephony to Paris and Nauen (Berlin).
		DH	Nauen, Germany	
		FP	(code)	8:15 a.m., English; 8:30 a.m. and 11 a.m., French, daily. 8:30 a.m. Sundays, French.
15.07	19,906	LSG	Monte Grande, Argentina	8-10 a.m.
15.10	19,850	WMI	Deal, N. J.	
15.12	19,830	FTD	St. Assise, France.	
15.20	19,720	EAQ	Madrid, Spain.	
15.25	19,600		Santiago de Chile.	
15.40	19,160	FZU	Tamatave, Madagascar.	
15.45	19,400	FRE	St. Assise, France.	
15.50	19,350		Nauen, France	4 to 5 p.m.
		VK2ME	Sydney, Australia.	
15.51	19,340	W2XAC	And higher waves	Press wireless.
15.55	19,300	FTM	St. Assise, France	10 a.m. to noon.
		PPU	Rio de Janeiro, Brazil.	
15.58	19,240	DFA	Nauen, Germany.	
15.60	19,220	WNC	Deal, N. J.	
15.94	18,820	PLM	Bandoeng, Java	5:10-6:40 a.m. and from 2:40 a.m. Tues. and Fri.; 8:40-10:40 a.m. Tues. Also telephony.
16.10	18,620	GBJ	Rodmim, England	Telephony with Montreal.
16.11	18,620	GBU	Rugby, England.	
16.19	18,500		Cottiano, Italy.	Telephone to ships.
16.30	18,400	PCK	Kootwijk, Holland.	Daily from 1 to 6:30 a.m.
16.33	18,370	PNC	Bandoeng, Java.	
16.35	18,350	WND	Deal Beach, N. J.	Transatlantic telephony.
16.38	18,310	GBS	Rugby, England	Telephony with New York. General Postoffice, London.
		FZS	Saigon, Indo-China	1 to 3 p.m. Sundays.
16.44	18,210	FRO	St. Assise, France.	
16.50	18,170	CGA	Drummondville, Quebec, Canada.	Telephony to England. Canadian Marconi Co.
16.57	18,100	GBK	Rodmim, England.	
		W9XAA	Chicago, Ill.	Testing, mornings.
16.61	18,050	KQJ	Bollinas, Calif.	
16.70	17,950	FZU	Tamatave, Madagascar.	
16.80	17,850	PLF	Bandoeng, Java ("Radio Malabar").	
		W2XAO	New Brunswick, N. J.	
16.88	17,830	PCV	Kootwijk, Holland.	9:10 a.m. Sat.
16.87	17,780	W8XK	Pittsburgh, Pa.	
16.90	17,750	HSIPJ	Itankok, Siam.	7-9:30 a.m., 1-3 p.m. Sundays.
17.00	17,640	Ship Phones to Shore	W8BN, "Leviathan"; GFWV, "Majestic"; GLSQ, "Olympic"; GDJJ, "Homeric"; GMIJ, "Belgianland"; work on this and higher channels.	
17.25	17,380	JIAA	Tokio, Japan.	
17.34	17,300	W2XK	Schenectady, N. Y.	Tues., Thurs., Sat., 12-5 p.m. General Electric Co.
		W8X1	Dayton, Ohio.	
		W6XAI	Oakland, Calif.	
		W7XA	Portland, Ore.	
		W7XC	Seattle, Wash.	
		W2XCU	Ampere, N. J.	
		W9XL	Anoka, Minn.	and other experimental stations.
17.53	17,110	W00	Deal, N. J.	Transatlantic phone.
		W2XDO	Ocean Gate, N. J.	A. T. & T. Co.

All Schedules Eastern Standard Time: Add 5 Hours for Greenwich Mean Time.

Meters	Kilo-Cycles	Station Name	Location	Notes
17.55	17,080	GBC	Rugby, England.	
18.37	16,320	VLK	Sydney, Australia.	Phone to England.
18.40	16,300	PCL	Kootwijk, Holland.	Works with Bandoeng from 7 a.m. Netherland State Telegraphs.
		WLO	Lawrence, N. J.	
18.50	16,200	FZR	Saigon, Indo-China.	
18.56	16,150	GBX	Rugby, England.	
18.68	16,080	MAA	Arlington, Va.	Time signals, 11:57 to noon.
18.80	15,950	PLG	Bandoeng, Java	Afternoon.
18.90	15,860	FTK	St. Assise, France	Telephony.
18.93	15,760	JIAA	Tokio, Japan	Up to 10 a.m. Beam transmitter.
19.01	15,750		Chi-Hoa, Saigon, Indo-China	Telephony.
19.50	15,375	FBBZ	French phone to ships.	
19.56	15,340	W2XAD	Schenectady, N. Y.	Broadcasts 3-6 p.m.; Sun., 1-3 p.m.; relaying WGY.
19.60	15,300	OKV	Lengby, Denmark	Experimental.
			Konigswusterhausen, Germany	After 7 a.m.
19.63	15,280	W2XE	Jamaica, N. Y.	
19.66	15,250	W2XAL	New York, N. Y.	
		W6XAL	Westminster, Calif.	
19.68	15,240	FYA	Pontoise (Paris), France	9:30-11:30 a.m. Service de la Radiodiffusion, 103 Rue de Grenelle, Paris.
19.72	15,210	W8XK (KDKA)	Pittsburgh, Pa.	Tues., Thurs., Sat., Sun., 8 a.m. to noon.
19.83	15,120	HVJJ	Vatican City (Rome, Italy)	5-6 a.m.
		JIAA	Tokio, Japan.	
19.99	15,000	CM6XJ	Central Tulumu, Cuba.	
		LSJ	Monte Grande, Argentina.	
		VK6AG	Perth, West Australia.	
20.20	14,850	HVJJ	Vatican City	Sunday, 5 a.m.; Tues. in English.
			Croydon, England.	
20.50	14,620	WMI	Deal, N. J.	
		XDA	Mexico City	2:30-3 p.m.
20.65	14,530	LSA	Buenos Aires, Argentina.	
20.70	14,480	W8XK	East Pittsburgh, Pa.	
		GBW	Rugby, England.	
		WNC	Deal, N. J.	
20.80	14,420	VPD	Suva, Fiji Islands.	
20.95	14,310	G2AH	Seething-on-Thames, England	Sat., Sundays, 3 a.m.
20.97-21.26	14,300-14,100	Amateur	Telephony.	
21.17	14,150	KKZ	Bollinas, Calif.	
21.50	13,940		Bucharest, Roumania	2-5 p.m., Wed., Sat.
21.59	13,890		Mombasa, East Africa.	
22.20	13,500		Vienna, Austria.	
22.33	13,100	WND	Deal Beach, N. J.	Transatlantic telephony.
22.68	13,220	Ship Phones		
23.00	13,043	0BE	La Punta, Peru	Time signals 2 p.m. to midnight.
		TGCA	Guatemala City, Rep. Guatemala.	10 p.m.-midnight.
23.35	12,850	W2XK	Schenectady, N. Y.	Antipodal program 9 p.m. Mon. to 3 a.m. Tues. Noon to 5 p.m. on Tues., Thurs. and Sat. General Electric Co.
		W2XCU	Ampere, N. J.	
		WDD	Ocean Gate, N. J.	
		W9XL	Anoka, Minn.	and other experimental relay broadcasters.
23.38	12,820		Rabat, Morocco	Sun., 7:30-9 a.m. Daily 5-7 a.m. Telephony.
23.16	12,780	GBC	Rugby, England.	
23.90	12,550	VBS	Glace Bay, Nova Scotia, Canada.	
24.11	12,290	GBU	Rugby, England.	
24.46	12,250	FTM	St. Assise (Paris), France	Works Buenos Aires, Indo-China and Java. On 9 a.m. to 1 p.m. and other hours.
		GBS	Rugby, England.	
24.63	12,280	Airplane	PLM, Bandoeng, Java	7:45 a.m.
24.68	12,150	GBS	Rugby, England	Transatlantic phone to Deal, N. J. (New York).
		FQD	FQE, Ste. Assise, France.	
24.80	12,090		Tokio, Japan	5-8 a.m.
24.80	12,090		Trieste, Italy.	
24.95	12,020	VIV	Ballan, Australia.	
24.89	12,045	NAA	Arlington, Va.	Time signals, 11:57 to noon.
		WSS	Annapolis, Md.	Time signals, 9:57 to 11 p.m.
24.98	12,000	FZG	Saigon, Indo-China	Time signals, 2-2:05 p.m.
			Oporto, Portugal.	

(NOTE: This list is compiled from many sources, all of which are not in agreement, and which show greater or less discrepancies; in view of the fact that most schedules and many wavelengths are still in an experimental stage; and that wavelengths are calculated differently in many schedules. In addition to this, one experimental station may operate on any of several wavelengths which are assigned to a group of stations in common. We shall be glad to receive later and more accurate information from broadcasters and other transmitting organizations, and from listeners who have authentic information as to calls, exact wavelengths and schedules. We cannot undertake to answer readers who inquire as to the identity of unknown stations heard, as that is a matter of guesswork; in addition to this, the harmonics of many local long-wave stations can be heard in a short-wave receiver.—EDITOR.)

Meters	Kilo-Cycles	Station Name	Location	Notes
25.10	11,945	KKQ	Bollinas, Calif.	
25.16	11,920	FYA	Pontoise, France	Variable beams to French Colonies, 12:30-2 p.m.
25.24	11,880	W8XK (KDKA)	Pittsburgh, Pa.	Tues., Thurs., Sat., Sun., 11 a.m.-4 p.m., and Sat. night Arctic Programs. Television, Mon. and Fri., 2:30 p.m., 60 lines, 1200 r.p.m.
		W9XF	Chicago (WENR)	
		W2XAL	New York (WENT)	
25.28	11,870	VUC	Calcutta, India	9:45-10:45 p.m.; 8-9 a.m.
25.30	11,860	VE9CA	Calgary, Alta.	
25.31	11,810	W2XE	Jamaica, New York (WABC)	7:30 a.m. through to 2 a.m. Sundays 8 a.m. to midnight.
		W9XAA	Chicago, Ill.	7-8 a.m., 1-2, 4-5:30, 6-7:30 p.m.
25.12	11,800	W2XAL	New York	
		W9XF	Chicago	
		VE9GW	Bowmansville, Canada.	
		PK6KZ	Maccassar, Celebes.	
		I2RO	Rome, Italy	Also relays Naples, 1:30-5:30 p.m.
25.47	11,780	VE9DR	Drummondville, Quebec, Canada.	
25.50	11,760	XDA	Mexico City	3-4 p.m.
25.50	11,750	G5SW	Chelmsford, England	7:30 S.-:30 a. m.; 2 p.m. to 7 p.m.
25.58	11,720	CJRX	Middlechurch, Man. Canada.	
		PPU	Rio de Janeiro, Brazil.	
25.63	11,690	FYA	Pontoise, France	Intercolonial broadcasting, 4-6 p.m.
25.65	11,680	YVQ	Maracaibo, Venezuela.	
25.68	11,670	KIO	Kahului, Hawaii.	
26.00	11,530	CGA	Drummondville, Canada.	
26.10	11,490	GBK	Bodmin, England.	
26.15	11,470	W8XK, S.S.	"Elettra," Marconi's yacht.	
26.22	11,435	DHC	Nauen, Germany.	
26.44	11,340	DAN	Norddeich, Germany	Time Signals, 7 a.m., 7 p.m. Deutsche Seewarte, Hamburg.
26.60	11,280	ONIBDK	Brussels, Belgium.	
27.30	10,980	ZLW	Wellington, N. Z.	Tests 3-8 a.m.
27.75	10,800	GBX	Rugby, England.	
28.00	10,710	CTIBO	Lisbon, Portugal.	Casablanca, Morocco.
		TGW	Guatemala City, Guatemala.	
28.20	10,630	PLR	Bandoeng, Java	Works with Holland and France weekdays from 7 a.m.; sometimes after 9:30.
28.41	10,540	WLO	Lawrence, N. J.	
28.50	10,510	RDRL	Leningrad, U.S.S.R. (Russia).	
		VLK	Sydney, Australia	1-7 a.m.
28.80	10,410	PKK	Kootwijk, Holland.	
		KEZ	Buenos Aires, Argentina.	
		LSV	Buenos Aires, Argentina.	
28.86	10,390	GBX	Rugby, England.	
29.30	10,250	T14	Heredia, Costa Rica	Mo. Wed. 7:30-8:30 p.m.; Thu., Sat., 9-10 p.m.
29.54	10,150	D18	Nauen, Germany	Press (code) daily; 6 p.m., Spanish; 7 p.m., English; 7:50 p.m., German; 2:30 p.m., English; 5 p.m., German, Sundays; 6 p.m., Spanish; 7:50 p.m., German; 9:30 p.m., Spanish.
29.98	10,000	CM2LA	Havana, Cuba.	
			Belgrade, Yugoslavia.	Monday 3-4 p.m.
30.15	9,950	GEU	Rugby, England.	
30.20	9,930	W2XU	Long Island City, New York	
			Posen, Poland.	
30.30	9,890	LSN	Buenos Aires, phone to Europe.	
		LSA	Buenos Aires.	
		EAQ	Madrid, Spain.	
30.64	9,790	GBW	Rugby, England.	
30.75	9,750		Aren, France	Tues. and Fri., 3 to 4:15 p.m.
		WNC	Deal, N. J.	
30.90				

Short-Wave Stations - When to Listen

(Continued from opposite page)

Table with columns: Meters, Kilo-cycles, Station Call Letters, Location, and Broadcast Schedule. Includes stations like CM2MK, CGA, GBC, etc.

Table with columns: Meters, Kilo-cycles, Station Call Letters, Location, and Broadcast Schedule. Includes stations like REN, W2XCU, W3XL, etc.

Table with columns: Meters, Kilo-cycles, Station Call Letters, Location, and Broadcast Schedule. Includes stations like HKE, ADA, HXD, etc.

"HAMS" PLEASE NOTE
At the suggestion of one of our readers, we are glad to announce that we will publish advertisements of radio experimenters, Hams, and all others who wish to swap or exchange used radio material.

(Continued on page 300)

ULTRA SHORT WAVE CONDENSERS

By DR. KARL STOYE

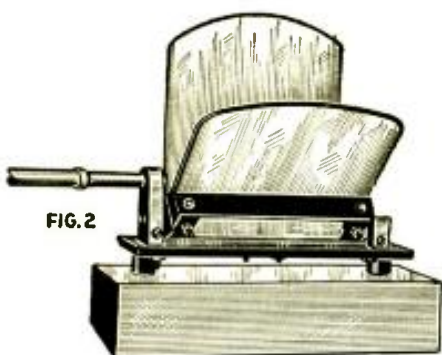

FIG. 2

This variable condenser was made from a honeycomb coil coupler and brass plates of desired size.

THE condensers described here have stood the test, both with transmitters and with receivers. The German short-wave amateur is compelled to make serviceable parts with slight means. Often one can put old parts together to make a new unit. A source of all kinds of serviceable parts is provided, for instance, by dismantled electric meters. Likewise, in the condenser shown in Fig. 1, the side-piece came from a meter.

The condenser consists of two brass cylinders with a sheet thickness of .04-inch and a length of 2 inches. The

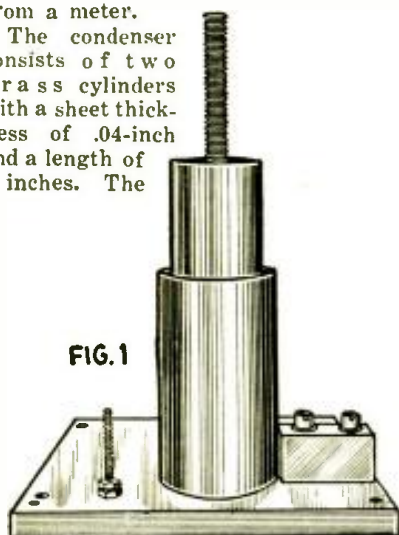

FIG. 1

upper cylinder (Fig. 3) has an outer diameter of 0.8-inch and an inner one of 0.72-inch. At both ends are put in threaded pieces .24-inch thick. The lower cylinder has an outer diameter of 1 inch and an inner one of 0.90-inch. The brass axle (with a thread) has a diameter of 0.2-inch and a length of 4.8 inches. It is fastened on an insulating plate 0.16-inch thick, by two hollow screws. The fastening must be secure, so that the inner cylinder will not strike the other in its rotation. Likewise the cylinder must, of course, so move up and down on the axle without wobbling; i.e., the thread must be cut very accurately. The connection of the condenser with the other parts of the apparatus is made, on the one hand, through the side-piece, by means of which also the outer cylinder is screwed tightly to the plate; and on the other hand, by passing the axle through

the plate and connecting it to the screw visible in Fig. 1. The up and down motion of the middle cylinder can be arranged in various ways; the author used a sort of hard-rubber fork for turning this cylinder.

The second condenser (Fig. 2) was produced from a honeycomb coil coupler with friction-hinge adjustment. Only the movable part is used; it was cut through in the middle. Two holes were bored through each part, in order to hold the movable plate tightly. The movable plate can be given different dimensions, according to conditions (3-, 5-, 8-meters wavelength). The writer used the following plate dimensions: movable, 3.2 inches high, 2.8 inches wide; fixed, 3.48 inches high, 2.8 inches wide. Fig. 4 shows the condenser as seen from the front. The plates consist of sheet aluminum 60 mils thick.—*Funk Bastler.*

The short-wave condenser at Fig. 1 was made from parts of an electric meter.

Fig. 3 illustrates section of variable condenser shown in Fig. 1; the upper cylinder moves up and down on a threaded rod.

Fig. 4 shows hinged type variable condenser.

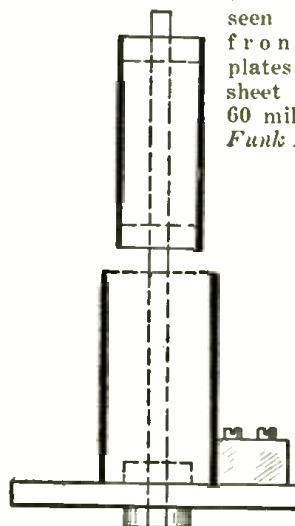

FIG. 3

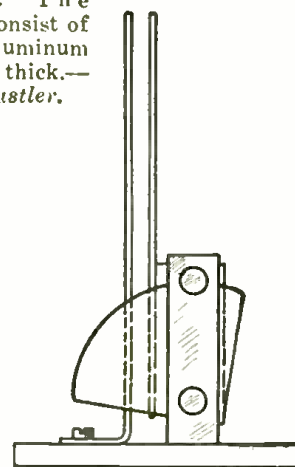

FIG. 4

Marvellous Reception by Coupling 2 Supers

By BURT H. TAYLOR, W1KB

(Continued from page 261)

phones on 20 and 80 meter bands from California with the volume of "locals" on the ordinary short wave receiver; also amateur phone signals from various other countries.

Now, to get back to code, all that is necessary to do is to pull the cord out of the second-detector socket and replace the tube and the grid leak, then put on the phones. The "HY-7" is coupled to the phones through one stage of audio.

Regarding this arrangement (using a local oscillator on the Graybar) I demonstrated to engineers of the Haverhill Electric Company by moving the Graybar to the other side of the room (where it was connected to another antenna) and then, with cord plugged to the second-detector socket of the "HY-7" and thrown up over the desk, I actually rebroadcast "Radio Roma" across the room to the

Graybar with no connection, and still had good house volume.

The accompanying diagram of the second detector socket of the "HY-7" shows how it is connected to the Graybar Superhet (or any receiver); making an automatic short-wave and regular-band receiver, and still being the "Rolls Royce" as a code receiver.

The Grid Leak shown is to be removed from clips when using the combination; or, as an alternative, the test cord is plugged into the plate connection of the same socket and connected to the Graybar's antenna post through a small fixed condenser. This probably gives a little more wallow, but I used the arrangement as shown the past year.

Now, as stated before, the "HY-7" I.F. is tuned to just above 1,500 kc. to allow the Graybar to tune just off the edge of

the regular broadcast band. You will note by that I have three stages of I.F. in this "HY-7" and that the detector stage is inductively instead of impedance coupled (all this was explained by Mr. Hatry in *Radio-Craft* last year, with diagrams).

With both sets switched on to receive short-wave broadcast or phone, the Graybar is dialed to just above 1,500 kc., and the short-wave tuning dial of the "HY-7" takes care of the rest, with the volume control on the Graybar. Now, to change to WEAf regular, all that is done is to reach over and turn the Graybar dial to that wave; and, ten to one, no further adjustment of volume control is necessary. With the Short-Wave dial left tuned to "Radio Roma" or any other, you can listen to WEAf on the test cord between the two sets.

Short Wave Question Box

Edited by R. William Tanner, W8AD

Push-Pull Transmitter Hook-up

Paul A. Johnson, Jamestown, N. Y., wants to know:

(Q.) A circuit of a good push-pull transmitter for use on 40 meters, using a plate voltage of 135 to 180.

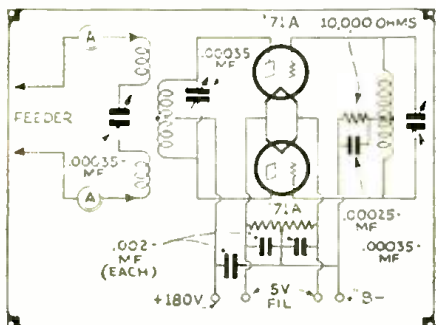

Diagram requested by Mr. Johnson, showing push-pull transmitter for use on 40 meters, using plate voltage of 135 to 180.

(A.) The circuit is given in these columns.
(Q.) What is the proper value of resistance to use across an audio transformer?
(A.) I assume that you mean the value of the resistor to shunt across the secondary, to eliminate "fringe howl." This will be somewhere between 100,000 and 250,000 ohms.

Wants Single Control Super-Het

Harold Berkman, Toledo, Ohio, wants to know:
(Q.) If it is possible to single-control the oscillator and first detector tuning condensers of a short-wave super-het?

(A.) Yes, it is easily possible to gang the condensers; but it is also necessary to shunt a vernier condenser across the first detector coil, and vary this at the same time the main dial is varied—and then, where is the single-control feature? There is none, of course.

(Q.) What size of fixed condensers to connect in series with each section of a two-gang .00035-mf. broadcast condenser, in order to tune the R.F. and detector stages of a short-wave receiver?

(A.) Fixed condensers of .00015-mf. capacity will be about right.

Best S.W. Converter

Jack Namaroff, Philadelphia, Pa., wants to know:

(Q.) What is the best type of converter to use with a broadcast set, to bring in short waves?

(A.) The type of converter using a screen-grid detector and '27 oscillator, utilizing the broadcast R.F. amplifiers as the I.F. amplifiers of a superhet, will afford the best sensitivity and selectivity.

Transmitter Inquiry

Orion Derlek, Dennis Port, Mass., inquires:
(Q.) Regarding the "Low Cost P-P Transmitter" (P. 129 Aug.-Sept. Issue)—can '10 tubes be used instead of '45's?

(A.) The '10 tubes may be employed; but this will require a power supply capable of delivering the proper filament and plate voltages.

(Q.) Can the coils be wound with solid copper wire, instead of tubing?

(A.) Yes, solid wire about the same size as the tubing can be used, with no decrease in output. Of course, for high-power transmitter

circuits, tubing would be far better; but, for transmitters of low power—using up to two 210 tubes—tubing is no better than solid wire, say No. 4 or 6.

(Q.) Can a Readrite ammeter be used to measure antenna current?

(A.) No, only a hot-wire or thermocouple meter may be used here.

Super-Converter

J. I. Frisman, St. Louis, Mo., asks:

(Q.) Can you give a circuit of a one-tube super-converter?

(A.) When are the short-wave fans going to do as the amateurs have done, and give up using an autodyne first detector in their super converters or superhets? Such a converter can only cause needless interference, to other short-wave listeners, of a type exactly like that caused by the old single-circuit regenerative broadcast receivers of a few years ago. This is, however, not the only disadvantage. It is necessary to tune the grid circuit to a frequency (differing from the signal frequency; the difference being the frequency of the I.F. amplifier. This *greatly* decreases the sensitivity. Also there are *always* two points on the dial for each station; no amount of pre-selector tuning eliminating this annoyance.

Transmitting Antenna

B. W. Ball, Houston, Texas, asks the following:

(Q.) Will you print a diagram of a suitable antenna for use with the transmitter (Page 129 Aug.-Sept. Issue)?

(A.) The diagram is shown here.
(Q.) Can this transmitter be used for phone transmission?

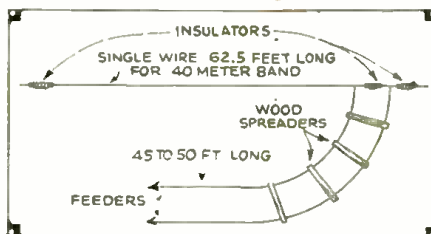

Data for constructing a short wave transmitting antenna with "feeder" line.

(A.) Modulating an oscillator directly is very unsatisfactory, and can only be accomplished at low percentages of modulation. Frequency modulation results, if the degree of modulation is much above 15 to 20 per cent.

Power Amplifier for Receiver

Charles Leininger, Venice, Calif., writes:

(Q.) Can you print a diagram of a power amplifier to use with a short wave receiver, using a '27 push-pull stage, followed by a push-pull pentode power stage?

Power amplifier for short wave receiver, using a '27 push-pull stage, followed by a push-pull "pentode" power stage.

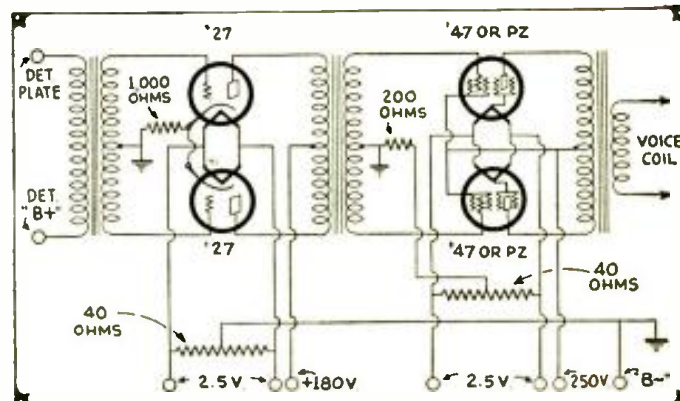

(A.) The circuit is given here.
(Q.) Would shielding eliminate hum, and what material should be used?

(A.) If the entire power supply is enclosed within a box made of sheet iron, hum due to induction should cause no trouble.

Circuit Query

Norton Smith, London, Ontario, Canada, asks:

(Q.) With reference to the circuit (page 23 June-July issue) what are the values of the condensers, resistors and audio transformers; and also what tubes are used?

(A.) The suggested values are as follows: .00014-mf. for the tuning and regeneration condensers; .00015-mf. for the grid condenser; and .00025 mf. for the antenna coupling condenser. The grid leak will be from 2 to 10 megohms, depending upon the characteristics of the detector tube. Using '01A tubes and a 6-volt "A" battery, the filament rheostats may be approximately 6 ohms.

Impedance and Choke Data

C. H. Bennett, Fall River, Mass., wants to know:

(Q.) What is the value of the impedance in Fig. 2 (Page 473 April-May Issue)?

(A.) This may be a regular type of 30-henry filter choke.

(Q.) What is the value of the R.F. choke in Fig. 1?

(A.) The article states that this choke consists of 40 turns of bell wire. However, a single-layer choke of, say, 150 turns of No. 36 wire on a 1/2" form would be preferable, on account of its lower self-capacity.

Two Tube Set

O. Long, Moose Jaw, Sask., Canada, inquires:

(Q.) What are the constants of the circuit of the two-tube set (Page 56 June-July issue)?

(A.) The constants follow:
L1, L2—any good set of plug-in coils;
C1—.00015-mf.;
C2—.00005-mf.;
C3—.0001-mf.;
C4—.000025 mf.;
C5—.00015-mf.;
R1—2 to 10 megohms;
R2—50,000 ohms;
R3—0.1- to 0.25-megohm.

Coil Size

Edward Camp, San Francisco, Calif., desires the following data:

(Q.) What are the sizes of coils (Page 474 April-May issue)?

(A.) For 12 meters, the grid coil would have approximately 4 turns and the flicker about 3 or 4 turns, when wound on a tube base. The turns should be spaced slightly. Any size wire from No. 30 to No. 24 will do.

How to Use a Wavemeter

By A. BINNEWEG, JR.*



The Delft wavemeter for measuring length of transmitted or received short waves.

D ID you ever look over a list of shortwave stations and then decide to see if you couldn't tune in some of the most distant (or "strange") ones? Undoubtedly you have done exactly that. You probably looked at the desired station's wavelength, then made a sort of a longing look at the dial on your receiver, and guessed where it would come in on your set. Chances are, you heard several possibilities near the place where you wanted to listen, and spent a lot of time tuning each one in and waiting for it to "sign." Well, all that is a lot of trouble and there's a way out! A wavemeter removes all of this guesswork and saves considerable time.

In fact, a wavemeter is an absolute necessity for every shortwave fan and experimenter. Dealers ought to use one to demonstrate their sets. It will help the fan tune in his stations and, to the experimenter, a wavemeter has numerous uses besides; such as checking receivers, getting the exact ranges that any coil you want to test will cover with a given condenser, checking the ranges that condensers cover with the same coil, testing oscillators and transmitters. Why, there is really no end to the uses of a wavemeter! No radio station or experimenter's laboratory is complete without one. Certainly, a wavemeter is much more essential than many of the useless "gadgets" one finds around the usual shortwave receivers. A popular, inexpensive wavemeter is shown in the photo herewith.

WHAT IS A WAVEMETER?

In its simplest form, a wavemeter is an accurate, calibrated tuned circuit. To use one, couple it closely to the secondary coil (tuned circuit) of the detector; be sure that the detector tube is oscillating. And be sure that the detector coil is being coupled to; it would be of no use to couple a wavemeter to a coil in the R.F. amplifier stages, because the sensitive condition does not obtain there. The detector tube should be just barely oscillating for best results. But be sure it is oscillating!

Be careful to use the proper plug-in coil, so that the wavemeter will tune to the wavelength that the receiver is tuned to. When thus coupled, and the dial of the wavemeter is varied, the detector tube will stop oscillating when the wavemeter-dial is tuned past the wavelength to

* Engineer, Delft Radio.

which the receiver is tuned. By varying the coupling between receiver and wavemeter, a very sensitive condition is soon found which yields very accurate results.

As soon as the point at which the wavemeter causes a click in the receiver (as heard in the headphones or loudspeaker) is found, the dial of the wavemeter is read and the wavelength to which the receiver is tuned is thus accurately found.

If an accurate wavemeter is desired, such as is necessary for general short wave tuning and test work, it must be calibrated from accurate standards. To design one of these instruments to cover the range of 14 to 250 meters, with the required overlap between coils, and such that the calibration remains constant, is a problem for shortwave specialists with the required laboratory apparatus. Careful shielding is also necessary to prevent hand-capacity effects.

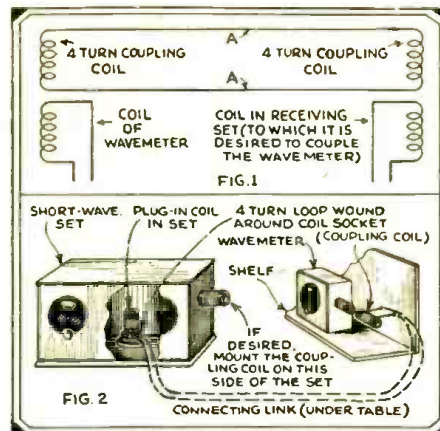

How wavemeter can be coupled to receiver by "link" circuit.

INTERESTING TESTS WITH A WAVEMETER

Suppose you wanted to locate a certain receiver dial-setting so that you could hear a certain station when it came on. First look up the wavelength of the desired station in *SHORT WAVE CRAFT*. Next select the particular coil which, when plugged into the wavemeter, will allow the wavemeter to tune to this wavelength. Then set the dial of the wavemeter to that wavelength. Bring the wavemeter close to the secondary of the receiver and vary the

receiver dial until you get the familiar click. When obtained, your receiver is tuned exactly to the proper wavelength and the desired station is then heard at once. It sounds long, perhaps, but it's all very easy, especially when you have a good wavemeter to start with and all the necessary instructions.

SPECIAL WAVEMETER CONNECTIONS

There are certain special cases where it is difficult to couple the coil of the wavemeter to the secondary (detector) coil in the set. The reason is that no plug-in coils are used in the short-wave receiver, making it unnecessary to have the coils readily accessible. Some sort of a switch is used in these sets. Instead of loose plug-in coils. In cases like this, the idea shown in Fig. 1 can be used. This consists of two small coils of about 4 turns each and a pair of wires serving as a connecting link. The connecting link is simply a closed loop with two 4-turn coils at each end of the line; each of these small coils is coupled to the desired coil in the usual way.

In this way, a wavemeter can be used with any set, no matter how far away the set is. If the leads A-A shown in Fig. 1 are made of sufficient length; the exact length makes no difference. The leads A-A can even be twisted together if desired, although results are a little better when they are kept apart about one-half inch. The line may be permanently installed, and the coil, which is coupled to the wavemeter, located at some convenient point near and outside of the set itself.

It is suggested that the small coupling-coil in the set be wound round the socket into which the set's plug-in coils are plugged, or coupled to the coils in some convenient way. One of the coupling coils can be wound on a tube-base if desired. Use about No. 18 wire for the coils and about No. 20 wire or so for the coupling line or connecting link. Couple one of the coils to the secondary of the set (just as you would couple the wavemeter coil itself) and couple the other coil to the wavemeter coil as shown in Fig. 1. The proper selection of coupling between wavemeter and coil to which it is coupled, will give the necessary fine adjustments.

The installation of one of these connecting links in a shortwave set is shown in Fig. 2. Of course, the coils used in the coupling link need never be changed, as they are of the correct dimensions for any wavelengths. The line with its coils remains permanently installed. It is better to use too-close coupling between the coil in the line, and the one in the set, than too loose; although the exact value to use is not at all critical.

New S-W Transmitters and Receivers

DELFT Radio has placed an entirely new and modern line of short-wave receivers and transmitters on the market for their large winter business. These sets include all modern features.

The receiving sets are designed for maximum distance at the lowest possible first cost. The new pentode tubes, costing little more than ordinary tubes, give results equal to two ordinary tubes and thus give loudspeaker volume where other sets, with the same number of tubes, give only results loud enough for headphones.

The Receiver Kits include a coil winder which makes the latest low-loss coils. In addition, each kit employs a pentode tube, which itself gives the amplification of two tubes. All in all, the loud volume obtained from these new kits is really surprising. In addition, the Kits are specially designed so that Television signals can be picked up. The reader is perhaps familiar with the fact that ordinary receivers cannot be used for television. Therefore, these kits can not only receive everything that goes on at

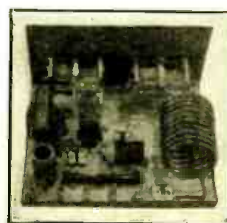

Above: New Delft S.W. transmitter kit assembled.

Right: Delft short wave receiver kit assembled.



short waves, but also television broadcasts as well.

The new Transmitter Kits are especially worthy of note. These kits include absolutely all transmitting parts so that any combination of tubes and batteries can be used up to 2 and including 2,

Type '45 or often 2, Type '10 tubes in parallel. No new parts need be purchased when larger power is used, because they will stand the higher voltage. Instructions are furnished so that AC tubes can be used, so no batteries at all are necessary if you are near, or have access to, light lines. The sets are for either AC or DC operation and will operate with batteries, "B" eliminators, power packs or any home-made power supplies you may make or purchase later. They are designed to operate in any short-wave band at high power if desired. Best of all, *no license is required* to experiment with one of these sets, so long as you do not connect a transmitting aerial to it. Thus, you can learn to adjust and operate these sets, and be prepared to pass the examination. Of course, these sets can be used on the air by even the *most experienced of amateurs* as well, as they are very pleasing to the eye. You can now have international communication by either code or voice for a very low price indeed!

SM AROUND the WORLD with the All-Wave SILVER-MARSHALL 726SW

In the 726SW there is available a combination of the very latest and most modern super-heterodyne broadcast and short-wave designs on one chassis.

In the 200 to 550 meter band, the 726SW is a nine-tube vario-mu pentode superhet employing nine tuned circuits. One precedes the '51 r.f. stage, a second is before the '24 first detector, and another with the '27 oscillator. The two tuned circuits ahead of the first detector, coupled with the '51 vario-mu tube, absolutely eliminate all cross-talk or image frequency interference. The two-stage i.f. amplifier, using '51 tubes, has a total of six tuned circuits (three dual tuned transformers) which definitely assures uniform and absolute 10 kc. selectivity at short or long waves.

A '27 second linear power detector feeds a compensated push-pull '47 pentode audio stage delivering from 5 to 7 watts undistorted power output, and in turn feeds a specially compensated electro-dynamic speaker unit.

The broadcast sensitivity ranges from less than one-half to seven-tenths of one microvolt per meter—so great that every station above the noise level can be tuned in easily. The selectivity is absolute 10 kc., and in any large city distant stations on channels adjacent to locals can be readily tuned in. From 60 to 100 different stations can be logged almost any night in any fair location.

The short-wave end of the 726SW is the dream of old—a true eleven-tube superhet using "double-suping" on not one, but two, intermediate frequencies. Yet it has but one dial—plus a non-critical trimmer! For short-waves, a '24 first detector and '27 oscillator ganged together are added by a turn of a switch, which selects between short-wave and broadcast band reception. A second selector switch chooses between four ranges (from 10 to 200 meters) at will—and all without a single plug-in coil.

The sensitivity, selectivity on short-waves are exactly equal to the broadcast band—giving thousands of miles of range.

Tubes required: 2—'24's, 3—'27's, 3—'51's, 2—'47's, 1—'80.

726SW All-Wave Superheterodyne, complete as described above, wired, tested, licensed, including S-M 855 electro-dynamic speaker unit. Size 20½" long, 12" deep, 8½" high. To be used on 110-120 volt, 50-60 cycle AC power. Price \$139.50 LIST.

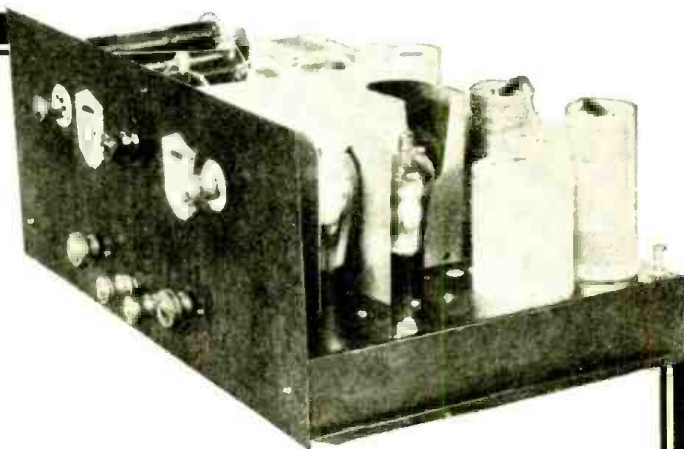

All in the 726SW

- Nine-Tube Broadcast Super
- Eleven-Tube Short-Wave Super
- No Plug-in Coil
- Pentodes in Push-Pull
- Three Vario-Mu Tubes
- Sensitivity Between .45 and .7
- Selectivity Absolute 10 kc.
- 10½" Electro-Dynamic Speaker

SILVER-MARSHALL, Inc.

6457 West 65th Street • Chicago, U. S. A.

Canadian Division: SILVER-MARSHALL of CANADA, Ltd.

75 Sherbourne Street, Toronto

Export Office: 41 Water Street

New York City, U. S. A.

SILVER-MARSHALL, Inc.
6457 W. 65th Street, Chicago, U. S. A.

Please send me full details on the S-M 726SW (enclosed you will find 2c).

Please send me FREE your new General Parts Catalog.

Name

Address

The total amplification of the receiver need not be used for the majority of long-distance reception, and for that reason there are two regulations for power; allowing the use of low amplification for the nearby more powerful stations. In fact, a range up to 2,000 miles in the broadcast band can be brought in with very good volume on low power, and only when extreme distance or short-wave reception is desired need the high power position be used.

How to Use Volume Control

Never advance the volume control past the point of stability. Tremendous amplification is available before oscillation will occur. The strength of the incoming signal is directly proportional to the amount of amplification required; and when a signal is so weak, due to atmospheric conditions, that same cannot be heard with a reasonable amount of amplification being used, nothing can be gained by advancing the volume control further.

Selecting Wave Bands By Switch

The range of the Lincoln De Luxe "32" equipment is from 15-550 meters. This range is divided into five groups to be selected by switch at left side of control panel and the range is divided as follows:

- 15— 30 meters 30— 50 meters
- 50—100 meters 100—200 meters
- 200—550 meters.

Each group will register from 0 to 100

The Lincoln All-Wave Super-Het

By H. WINFIELD SECOR.

(Continued from page 251)

on the dial. For instance, in the 15—30 meter band the 15 meters will register at low end of dial and the 30 meters at upper end of dial, and likewise throughout all of the group. The De Luxe "10" and "32" models tune very sharp and dial must be accurately set in resonance with the station as it is very easy to

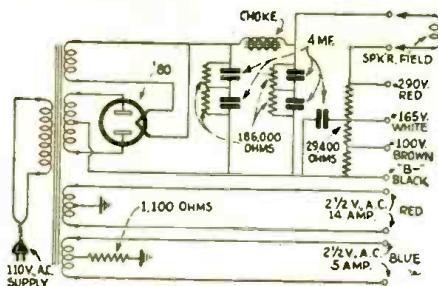

Diagram of Lincoln power supply.

pass over a short-wave station, especially in the higher frequencies. Also, it is very essential that the left-hand antenna trimming knob should be kept in resonance to bring in the signals.

Now assume that you wish to tune in G5SW (Chelmsford, England); from your log book you note that this station

uses a wavelength of 25.53 meters which falls in the 15-30 meter group. So merely turn the selector switch to the 15-30 meter position; turn your dial to about 65; bring the antenna trimmer to resonance; and tune slowly both sides of this position until G5SW is located. When W8XX is broadcasting on 25.25 meters, G5SW can be quickly located about one dial division above them.

The above procedure is followed for all short-wave reception. Stations in the 31-meter band are found on the lower portion of the dial when selector switch is set on the 30-50 meter position. The 49-meter band stations will then be found around 70 on the dial. The 85-meter band will be found near 60, with switch in the 50-100 meter position. One group of police calls will be found near 30 and another group near 70, with switch in the 100-200 meter position.

Tuning In the Broadcast Range

In placing the selector switch in position from 200-550 meters, you can tune the complete broadcast range; 200 meters coming in around the neighborhood of 5 on the dial. Where there is only one station to a channel, this station can be brought in if signal is available. Where more than one station is operating on the channel at the same time, a heterodyne will be found which is beyond the power of any receiver to separate. Many such channels will be found in the low- or wavelengths in the broadcast band, where from two to ten

50c. the Copy

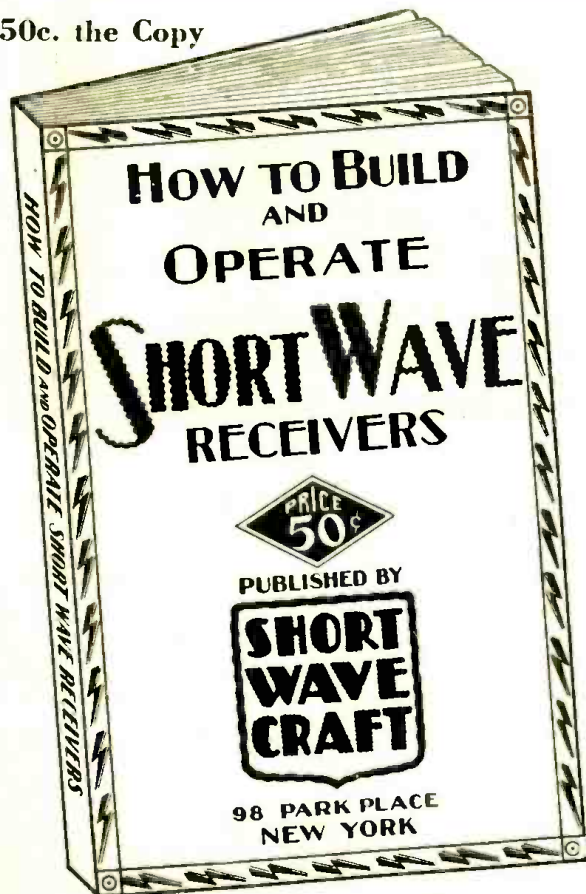

And NOW!

THE greatest book of its kind ever published. HOW TO BUILD AND OPERATE SHORT WAVE RECEIVERS is the largest and most up-to-date book on the subject ever put between two covers.

The book has been edited and prepared by the editors of SHORT WAVE CRAFT, and contains a wealth of material on the building and operation, not only of typical short wave receivers, but short wave converters as well.

Dozens of short wave sets will be found in this book, which contains hundreds of illustrations; actual photographs of sets built, hook-ups and diagrams galore.

WE SAY—AND REPEAT IT—THAT NOTHING LIKE THIS HAS EVER BEEN PUBLISHED BEFORE.

We could easily wax enthusiastic about this book, but we prefer to let you be the judge, and we know in advance from the letters that we will receive, that this is the ONE book short wave enthusiasts have been looking forward to for a long time.

The book comes with a heavy colored cover, and is printed throughout on fine-class bound paper. No expense has been spared to make this the outstanding volume of its kind. The book measures 7 1/2 x 10 inches.

This book is sold only at such ridiculously low price because it is our aim to put this valuable work into the hands of 50,000 short wave enthusiasts toward the end of this year.

Published by the publishers of SHORT WAVE CRAFT magazine. This alone will be your guarantee that it is a really worthwhile publication.

We know that if you are at all interested in short waves you will not wish to do without this book. It is a most important and timely new radio publication.

SHORT WAVE CRAFT
96-98 Park Place,
New York City. SWC-12
Gentlemen:—

I enclose herewith fifty (50c) cents for which please send me upon publication, a copy of your new book HOW TO BUILD AND OPERATE SHORT WAVE RECEIVERS. (Send money order, check, cash, or new U.S. Stamps. Register letter if it contains currency or stamps.)

Name
Address
City and State.....

Rush Coupon Today.

stations are allowed to operate at the same time.

This switch should always be in "radio" position when radio is used. When phonograph pick-up is used, place switch in *phono* position and turn volume control to point just above the position where switch shuts off.

The oscillator coil assembly is composed of four short-wave oscillator coils, and one broadcast oscillator coil, with the ranges mentioned in the previous data. Each oscillator coil acts independently and is selected by a special selector switch; the switch being of the double-wiper type, with a rotor not common to the shaft.

A 2-Tube Receiver—12,500 Mile Range

By WALTER C. DOERLE

(Continued from page 258)

doubtedly call for home-made plug-in coils, because of their convenience, we follow up our diagram with a discussion of this type of coil for the oscillating circuit. To hold the wire in place on the tube-base, the author has found orange shellac to have small loss, and it gives a shiny finish to the form. As to the condensers for use in this receiver, select those that have the smallest amount of dielectric in supporting the stator plates.

Have you ever experimented with various values of grid condensers and leaks in the detector circuit? Well, get about twelve leaks ($\frac{1}{2}$ to 10 megs), and twelve different sizes of grid condensers (.006 to .0001-mf.), but first of all figure out the possible number of combinations.

Use a 5-megohm leak and .0001-mf. grid-condenser. These values will make the receiver very sensitive.

Now, in our discussion we are near the audio-frequency transformer and our eyes immediately behold an R.F. choke. Gee, what a mean thing for the temper; but, at any rate, 300 turns of No. 36 D.S.C., magnet wire, close-wound on a $\frac{1}{2}$ " wooden dowel, will choke the R.F. current out of the transformer primary, even at 20 meters.

As to the audio transformer, we can't boast for any type; but a good 5 to 1 ratio and a hefty type, will be good.

The following is a list of parts for the set proper:

- 1—Bakelite panel 7"x10";
- 1—Baseboard 9x11";
- 3—UX Sockets;
- 1—Tuning Condenser .00014-mf.
- 1—Throttle Condenser .00025-mf.;
- 2—Condenser Plates $1\frac{1}{2}$ " square;
- 7—Terminal Post-strip;
- 7—Binding Posts;
- 5—M-gohm Grid-leak;
- 1—.0001-mf. Grid Condenser;
- 1—5:1 Transformer;
- 2—Telephone Bludging Posts;
- 2—3" Dials;
- 1—20-Ohm Rheostat;
- Hook-up wire, screws, etc.

COIL DATA

Range (meters)	S	Turns	T
15-45	5		6
25-75	9		5
60-125	16		6

All coils are close-wound with No. 24 enameled copper wire, and with no spacing between S and T.

WORKS ON ANY RADIO!

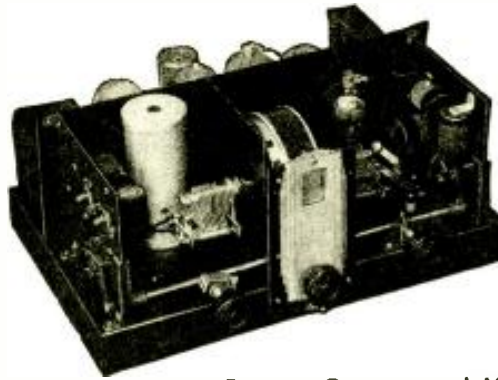

NATIONAL N. C. 5 CONVERTER

Extends the range of your own radio to bring in short-wave broadcasts and code from anywhere in the world. Contains exclusive features and additional equipment not found elsewhere, giving it a real punch and wallop that sets a new standard in converter performance.

Easy to Connect and Use With Any Radio

Connect antenna to converter and converter to antenna post of radio. Need not be disconnected when receiving ordinary broadcasts. Has own built-in power supply. R. C. A. License.

Extra Amplification Stages

The NC-5 Converter has exclusive HARMONIC TUNED INPUT CIRCUIT, automatically resonating a stage of high-frequency amplification, plus an additional stage of high gain amplification, which also serves as a low impedance coupling with the set.

Single Control Tuning

Specially designed to make circuits "track" each other accurately. No interlocking or "dead-spots". Operation is stable over the range.

No Plug-In Coils

The NC-5 Converter has a new coil-switching system with practically perfect results for converter use, but without the inconvenience of plug-in coils. The new

design helps, but R-39, the remarkable low-loss dielectric especially developed for National Company by the Radio Frequency Laboratories, really makes it possible. No ordinary insulating material works as well. There is no intercoupling between coils.

A Change in Color of Dial-Light Indicates Which Coils Are in Circuit

Attractive—Compact

Size, 8" x 17 $\frac{1}{2}$ " x 12". Standard Mode in beautifully finished metal cabinet.

TUBES USED

Two 235's, two 224's, one 280

De-Luxe Model

In hand-rubbed solid mahogany case with genuine inlay in front panel. Harmonizes with the most beautiful radio sets.

and— NATIONAL SW-5 THRILL-BOX

"What a kick this set has! Foreign stations so loud that you can hear the announcements three rooms away." . . . "I guarantee Rome, Italy on the loud speaker and the SW-5 has never failed me yet." "Neatness, precision, good results." . . . "5 continents and 23 countries received." . . . Truly a masterpiece in the SW field." (Names on request.) So write a few admirers of the SW-5 THRILL-BOX, the outstanding short-wave receiver for serious every-day short-wave phone or broadcast reception, for code or experimental use. If you have a regular radio and want to hear short-waves occasionally, the NATIONAL NC-5 Converter has just been announced (see above) but for every-day short-wave performance the THRILL-BOX is the receiver of them all.

Send in this COUPON for full information and prices

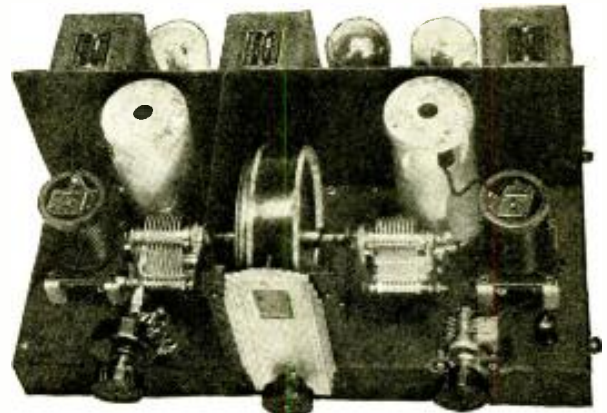

High-Lights on the SW-5

Range 9-2000 meters. Extremely high signal to noise ratio. True single-knob tuning. Set and forget the antenna trimmer. Easy to log with NATIONAL projector Dial, type H, no parallax. Special 270° Type S. E. Tuning Condenser with insulated main-bearing and Constant-impedance pigtail makes gang-tuning possible on the short waves. Equipped with standard set of 4 pairs of R. F. Transformers covering range of 15 to 115 meters, wound on forms of genuine NATIONAL R-39. Uses the new UX-235 Variable-Mu tubes, giving improved sensitivity and less critical operation. Humless A.C. Power Supply with special filter section. R. F. Filter on Rectifier Tube, and Electrostatic shield. R. C. A. Licensed.

NATIONAL SW-5 THRILL-BOX



NATIONAL COMPANY, INC.
61 Sherman Street, Malden, Mass.
Gentlemen:

- Please send me complete information and prices on your new NATIONAL NC-5 Converter.
- Please send catalog sheets on the improved SW-5 THRILL-BOX.
- I enclose 50c (stamps or coin) for your 64-page Handbook of Short-Wave Radio, describing in full the latest and best short-wave receiving circuits, adapters, converters, meters, etc.

Name

Address SWC-2-32

CLAROSTAT

**SHORT WAVE
and TELEVISION
CONTROLS**

**SPEED CONTROL
CLAROSTAT**

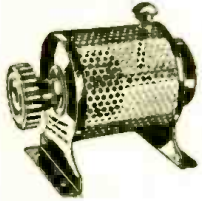

for
SCANNING
DISC
CONTROL
and Heavy Duty
laboratory use.

STANDARD CLAROSTAT

for
KINO LAMP
CONTROL
REGENERATION
CONTROL
PLATE VOLTAGE
CONTROL



**CLAROSTAT
WIRE WOUND
POTENTIOMETER**

for
VOLUME
CONTROL
Synchronizing
Control
Regeneration
Control
Bias and Plate
Voltage

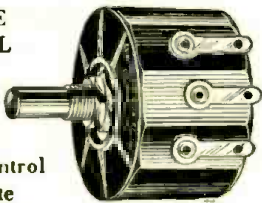

**CLAROSTAT
GRAPHITE ELEMENT
POTENTIOMETER**



for
Volume Control
Oscillation
Control
Tone Control

Write for Literature
Mention "Short Wave Craft"

Clarostat Mfg. Co., Inc.
285 N. 6th St. Brooklyn, N. Y.

Locating Ore Deposits By Ultra Short Waves

By A. BINNEWEG, JR.

(Continued from page 255)

transmissions of any nature whatsoever! It is readily seen, therefore, that ¼-meter operation results in greater portability of the apparatus and more satisfactory licensing conditions.

Construction of ¼-Meter Apparatus

There are a number of precautions which must be taken in the construction of apparatus for operation below one meter. It is not difficult to make most tubes operate at 1.5 meters, or so, but the operation of a ¼-meter oscillator is much more difficult.

Fig. 3 shows the essential connections for a ¼-meter oscillator. The radio-frequency chokes and grid-leak can be constructed like those already described for the 1.5-meter oscillator. The condenser, C, in Fig. 3 should be about 100 mmf. Undoubtedly, the experimenter will bring about many improvements in the design and circuit constants of Fig. 3, but the values shown should be used for first trial. The coil, L, of Fig. 1 has now been reduced to simply two parallel wires, and one of the condensers of Fig. 1 has been omitted. It is extremely important that the internal capacities of the tube used should be small. It is suggested that the work be carried out with a tube designed especially for operation at these frequencies.

The operation of any transmitter, at frequencies of the order of one meter, is such that modulation of the carrier is desirable. The wave transmitter, especially when batteries are used, is so sharp that it is often lost in receivers commonly used. For this reason, the wave must be broadened so that it can be easily picked up. The wave can be easily broadened by coupling the output of an audio-frequency oscillator into the grid circuit of the transmitter; such a complete arrangement is shown in Fig. 5. The oscillating circuit of the audio-frequency oscillator consists of an audio transformer. The audio oscillator is coupled through an amplifying tube connected across the grid-leak of the

transmitter. Other arrangements than Fig. 5 are possible, but this circuit has worked out well. The dotted lines in Fig. 5 suggest that both transmitter and amplifier tubes can be operated from the same plate battery if desired.

75-Centimeter Receivers

The ultra-short-wave receiver has the circuit shown in the accompanying drawing. Its response will be found quite broad; nevertheless, it should be tuned for a maximum effect. It is suggested that the reader try a crystal detector also, since the loading effects of ordinary tubes can be overcome. This can be judged near enough, perhaps, by listening in on the receiver at a distance from the transmitter, and sliding the fixed condenser (in the receiver's input circuit) along the parallel wires. If a power tube is used in the transmitter, it will be found that the tuning of the receiver will be quite different, because of the smaller tube (and consequently smaller internal constants) used. Use an extension handle to adjust the set; otherwise the presence of the body will have a detuning effect.

It is perhaps not necessary to state that there is much experimental and developmental work to be done yet on ¼-meter waves. The superheterodyne, in which a harmonic of the oscillator beats with the incoming signal to produce a low intermediate frequency seems, off-hand, to be a solution. The arrangement suggested here is not to be considered a final arrangement but as a good beginning. If you want to use an aerial on the ¼-meter receiver, for greater signal, take a piece of No. 14 wire (or even a piece of copper tubing, for rigidity) about 30 inches long, or so, and run about half an inch of it near the grid of the detector tube. Maybe you can show us a better arrangement, after you have tried it! Better get the transmitter blasting first!

A very novel supporting frame for a parabolic reflector is shown in accompanying sketches. By a hinged arrange-

**VOTING COUPON
For Proposed Radio 'Phone League**

I have read Mr. Gernsback's article on the proposed amateur Radio 'Phone League, and I approve of the movement.

I believe I can secure _____ members for the new League.

I think I can organize a local chapter of the League in my own town.

I understand that signing this blank obligates me in no way whatsoever.

Name

Address

City..... State.....

EVERYTHING

on the Air

with ONE RECEIVER

THE entire theatre of the air is yours with this powerful, eight-tube, world-girdling, Hammarlund Super-Heterodyne. By merely slipping in and out the five pairs of plug-in coils, *all wave bands from 14 to 550 meters*, at home and abroad, are brought to your loudspeaker, crisp and clear.

Uses the new Variable Mu tubes. Highly selective. Marvelous, controlled tone from resistance-coupled amplifier with Pentode output. Long-wave oscillator for pure code note.

The perfected product of Hammarlund's more-than-30-years of precision engineering. Handsome console cabinet, with hinged top, dynamic speaker and all tubes—*complete \$175.00*



HAMMARLUND-ROBERTS, Inc.
424-438 W33rd Street, New York.

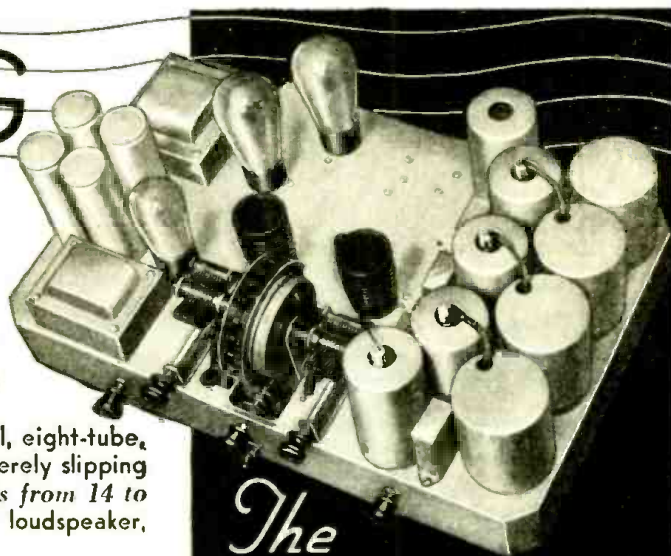

The
HAMMARLUND
"COMET"
All-Wave RADIO

Write Dept. SW-6 for
DETAILED DESCRIPTION.

ment, the reflector can be tipped and properly "aimed" at the hidden ore-bed; in order to obtain a maximum response at the receiver. By noting responses over different kinds of ground (the surface of the earth also reflects waves), one can "calibrate" the instrument, and know exactly what the outlines of the deposit, or underground lake, are. Gold, of course, or even buried treasure, if you are looking for it. (Who wouldn't be, if they knew where it was?) Anyway, this $\frac{3}{4}$ -meter stuff will make it easier to locate!) will have its own characteristic reflections, as noted by the responses received at the receiver. The reflector should be fitted with a degree-reading scale (such as a protractor) so that more accurate results will be secured.

The reader is warned not to expect too much at first from experimental apparatus of this nature. *Do not* build up a set in a hurry, rush out into the field, and expect to get immediate results. Experiment with it. Try out the transmitter first at some wavelength near 3 meters or so, then reduce the wave as low as you please; and go easy, or you'll get lost!

You can use a small aerial on the receiver, or even arrange a more complicated arrangement with a reflector, as at the transmitter. The receiving aerial will then be the aerial at the focus of the parabola. Couple this aerial to the set by running a length of wire parallel

to the aerial, and from there to a point near the grid of the tube.

For $\frac{3}{4}$ -meter operation, tubes are a problem. (For details see October-November *SHORT WAVE CRAFT* for an article on this subject by this writer.) For preliminary experiments, use a type '10 tube. For considerable power, use a UX-852 or a De Forest "H" tube. By using an R.F. transmission line, the power supply can be located at a considerable distance from the place where one is actually exploring. However, for work in the field, smaller tubes such as the type '30 dry-cell tubes must sometimes be used, although the results will not be so satisfactory. The most practical arrangement would be to use a gasoline engine driving a generator, for field work; in this way, the desired power could be obtained for the larger tubes.

To the man with small means, it is suggested that extensive experiments be carried out in some convenient location, in order to determine just "how little one can get by with" when the apparatus is to be carried into the field. Try out the preliminary work described in the October-November issue, before writing me.

A METER FOR ULTRA WAVES

If a sufficient number of requests are received for this wavemeter, Mr. Binneweg, Jr. will supply them at cost price (\$5.95 post-paid) to the readers of *SHORT WAVE CRAFT*. Mail your orders to the editor and if a sufficient number are received to warrant Mr. Binneweg carrying out his liberal offer, he will do so; otherwise the money will be returned to the readers.

The wavelength range covered (range 3 to 5.5 meters) by this ultra-short-wave meter will include the amateur 5 meter band. Mr. Binneweg states in his letter to the editor, "don't ask for any other ranges." The wavelength embraced by the instrument will permit the readers to become sufficiently acquainted with these frequencies to carry out experimental work with reflectors, and to apply such experiments to prospecting apparatus, etc.

The wavemeter will look approximately like the one shown on the enclosed illustration herewith.

If you are interested in obtaining one of these special ultra-short-wave meters, please send your check, or money order, together with your order to the Editor of this magazine.



3 to 5.5 meter wavemeter.

Navy Transmitting Tubes, 5 watts, made by G. E. 550 volts plate, 7.5 filament. All new and in original boxes. 75c

- UX210's, 15 watt rating. \$1.50
- UX250's 100% modulator. \$1.50
- UX281's, 110 mil. Rectifier. \$1.50
- Flament transformer for above tubes gives 7.5 volts at 2 amps. 15 watts center tapped. \$1.00
- 866 Mercury Vapor Rectifiers lowest price ever offered. \$2.95

RCA LICENSED TUBES

- UY227's. \$.35
- UX245's, each \$.55 and UX171A's. \$.45
- UX201A's, each \$.45 and UX226. \$.55
- UY224's, each \$.65 and UX280. \$.65
- The New Power Pentode, U247. \$.95
- New 2 Volt Power Tubes 230, 231, 232. \$.75
- New 2 Volt Power Pentode, 233. \$1.00
- UY235. \$1.00
- 236, 237, 238, Auto 6 Volt Tubes. \$1.00
- Genuine Mershon Electrolytic Condensers. \$.95
- Neon tubes for wavemeters in handy carrying case. \$.50
- Bakelite subpanel wafer sockets, UX or UY. \$.05
- Hard rubber panels, 7x10, 7x12. \$.55
- Western Electric Single Button Microphones. \$1.00
- Mesco Transmitting Keys. \$1.25

RADIOBUILDERS CONDENSERS

Mfd.	800v.	1000v.	1500v.	2000v.	3000v.
1	\$1.10	\$2.00	\$2.95	\$ 4.75	\$ 6.95
2	\$1.55	\$3.00	\$3.95	\$ 8.00	\$12.50
4	\$2.75	\$4.00	\$5.50	\$14.00	\$19.95

Above condensers tested at 40% overload.

Self-Healing Puncture Proof CONDENSERS

Mfd.	800v.	1200v.	1600v.	2000v.	2800v.
1	\$3.95	\$ 6.00
2	\$3.00	\$3.35	\$6.00	\$ 9.25
4	\$2.50	\$4.25	\$4.20	\$8.50	\$16.00

All condensers in heavy metal containers with large terminal insulators. Above ratings actual DC working voltages. All guaranteed.

- 800 volt Mica condenser, .0001 to .006. \$.15
- Stand off insulators, similar to GR, each. \$.09
- Air King Short Wave Coils, set of four. \$1.75
- .0001 midget condenser for above. \$.50
- Push Back Hook-up wire, 25' roll. \$.20
- Electric Soldering Irons. \$1.00
- Latest Amateur Call Books. \$.82
- Milliammeter 0-10 for Dynatron Oscillator. \$1.25
- Milliammeters 0-15, 0-25, 0-50, 0-100, 0-150, 0-200, 0-300, 0-400, each. \$1.00
- AC volt meters 0-6, 0-10, 0-15, each. \$2.50
- 7x18x7 solid walnut cabinets, special. \$1.00
- 2000 ohm head phones, pair. \$1.20
- Copper coil 2 1/4" diameter, 1/4" tubing, turn. \$.09
- Radiobuilders transmitter RF chokes. \$.50
- 20 ohm Kurech Kaach rheostats, 2 volt tubing with knob. \$.20

We specialize in obtaining complete kits for transmitters and receivers as described in Short Wave Craft. All merchandise guaranteed.

TERMS: Cash or C.O.D. no deposit required. All prices F.O.B. Irvington, N. J.

Visit our store when in town.

JUST SEND FOR OUR SPECIAL AMATEUR SUPPLY CATALOG. IT YOU WANT REAL RADIO PARTS AT LOWEST PRICES.

UNITED RADIOBUILDERS
1234-36 SPRINGFIELD AVE.,
IRVINGTON, N.J.

WE ARE RADIO BUILDERS AND APPRECIATED WITH SPECIAL EXPERT ATTENTION.

Planes Can Land in Fog By LIEUT. MYRON EDDY

(Continued from page 249)

any desired angle above the horizon to the projected beam.

The transmitter projecting the localizing beam along the runway operates on about 1,200 meters. It is a 200-watt set and uses small loop antennas. When signals from this beacon are picked up, the landing beam receiver aboard the plane is immediately switched on.

There is a horizontal doublet type antenna about five feet long on the plane, employed for the short-wave landing receiver. The regular airways beacon receiver, either visual or aural, takes care of the airways beacon, the airport boundary marker beacon along the runway.

The boundary beacon consists of a 50-watt transmitter feeding a loop-type antenna. Modulation of the radiated wave to the desired frequency, 1,000 cycles per second, is obtained by supplying the transmitting tube with a plate voltage of 1,000 cycles frequency. On the airplane, earphones connected in series with the main course indicator are employed with a special filter circuit. The boundary line is defined by a zero, as the plane passes over the boundary line; then an increasing signal as he comes within the landing-field area,

On the airplane, the signal current in the output circuit of the special short-wave receiving set employed to receive the landing beam is first rectified and then passed through a landing beam "indicator". This "indicator" is mounted on the instrument board of the plane.

To help in maneuvering onto the field a "rough distance indicator" has been developed which is also automatic. It works like the ordinary tuning meter, found on any receiver which has automatic volume control, and constantly indicates to the pilot the approximate distance of the

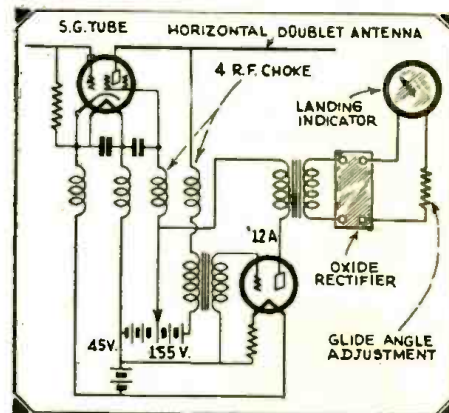

Diagram showing elements of landing beam receiver and indicator carried on plane.

plane from the localizing-beam transmitter. This transmitter is usually just back of the landing beam transmitter; and so the pilot usually "sets her down" just before the rough distance indicator registers zero—whether he feels like it or not! Otherwise he piles up on the transmitter antennas—if he does not see them at the last instant.

New All-Wave Receiver Using Auto Tubes By BERYL B. BRYANT

(Continued from page 253)

The only other additional part to be made is the plate for the ground and antenna binding posts; this is made of bakelite. The bakelite is laid out, and drilled in accordance with Fig. 1D; and the parts mounted. At this time the binding-post panel may be wired completely, mounting the antenna resistor underneath. After doing this, the binding-post panel is mounted on the top panel, immediately behind the radio-frequency tube. The panel is mounted and spaced from the metal base with long 6/32 brass screws and nuts; the height of the panel being made sufficient to clear the antenna resistor, R1.

Wiring the Receiver

In wiring this receiver, as well as any other, in which metal is employed for the chassis, it is excellent practice to wire in the same manner as if the chassis were made of some insulating material. In this way the ground circuit will be of the same radio frequency potential; whereas, if the metal chassis is used for the common connection, various points of the chassis will be at different radio-

frequency potentials, which will give rise to oscillations, broad tuning, and a multitude of other troubles.

The filaments are first wired, beginning with the radio-frequency tube; then across at the front to the detector, and lastly to the pentode. The negative of the filament is also grounded to the chassis at this point. A lead then runs to the filament switch and then out of the box. The supply lead for the positive filament should be of the same length as the negative lead from the switch; both should be about two feet in length or longer if desired.

Following the circuit diagram, Fig. 2, the Sprague bypass condensers are soldered directly to the socket prongs, with the ground ends soldered to the same point at which the bias resistors are grounded to the negative filament. A long lead is provided for the screen grid of the R.F. socket V1, of such a length to reach the volume control R7 when the top and the front panels are placed together. A lead is connected from the ground binding post B2 on the bakelite panel through the metal panel and con-

nected to the grounded end of the 500-ohm R.F. biasing resistor R2. The plate of the R.F. tube is connected to the "G" of the coil socket; and a long lead is provided from this point, to reach the stator of the tuning condenser when the panels are assembled. The condenser C6, which bypasses the secondary to ground, is soldered to the filament of the coil socket on the same side of the "G." This prong is also the plus "B" of the R.F. tube. The plate of the detector tube is next connected to the "P" prong of the coil socket, and the "F" prong of the coil socket is then provided with a lead, to connect to the stator of the regenerative condenser.

The grid leak R3 and condenser C7 are next connected by soldering the condenser to the "G" post of the coil socket, and the resistor to a ground point. A lead is run from the junction of the condenser and resistor to the grid post of the detector socket V2. The R.F. choke is next fastened into position, as shown, at a sufficient height from the bottom of the top panel to clear the .02-mf. coupling condenser C8.

The plate resistor R4, of 100,000 ohms, is soldered to one terminal of the choke, while a lead from the detector "P" prong of the socket V2 is soldered to the other terminal of the choke. The grid leak R5 of the power tube is soldered to one end of the condenser C8, and its other end to a ground point. The 1500-ohm biasing resistor of the pentode, R6, and its bypass condenser C9 are next soldered to the cathode terminal of the pentode socket V3, and their other ends to a ground point. A lead is next soldered to the junction of the condenser C8 and the gridleak R5, and passed up through the metal panel to the control-grid of the pentode. The free end of the detector plate resistor R4 is next connected to the "F" prong of the secondary of the coil socket, and then to the screen grid of the pentode socket V3. A lead is soldered to the plate prong of the pentode socket V3, and is later connected to the binding post B3 on the back panel.

The corner posts are next fastened to the corners of the top panel, and the front panel slipped into place. The leads from the "G" prong of the coil socket and from the "F" side of the tickler are connected to the tuning and regeneration condensers respectively. Next the side panel with the switch is placed in position. A lead from the screen-grid prong of the R.F. socket V1, which is bypassed by the condenser C5, is connected to the center terminal of the 50,000-ohm volume control R7. One side of R7 is connected to one of the terminals of the switch at position 1; the negative filament lead from the pentode socket is connected to the switch terminal 2, with the long lead provided on the common terminal of the switch running out. A long lead for the current supply of the R.F. screen-grid is soldered to the remaining terminal of the volume control.

The back panel is next put into position, soldering the lead from the plate of the pentode to the binding post B3. The plus "B" lead of the R.F., from the detector, and the pentode screen-grid are

ROYAL

SHORT WAVE TRANSMITTER RECEIVER, AND POWER SUPPLY KITS AND SETS

Takes the guesswork out of home construction! Every part needed down to the last nut is included. Complete construction and operating instructions in simple terms, easily understood by anyone. These scientifically designed kits use the highest grade parts throughout to obtain maximum results. Also supplied AWT (Assembled, Wired and Tested).

SHORT WAVE RECEIVERS

For reception (from foreign countries as well as U.S.) of broadcasting, code, airplane reports, television signals, ship conversations, police transmitters and others. All necessary parts including drilled panel and complete instructions. Micro-vernier dial makes close tuning easy. Any combination of tubes and batteries can be used. These sets are guaranteed to give better results than any others. Coil and condenser combinations given to cover from 14 to 200 meters or for amateur bands for "Hams." State your choice when ordering.

Model R1—A sensitive one-tube receiver with a world-wide range! Special refinements make this set superior to any other. AWT, \$9.25. Kit, \$5.95.

Model R2—Same as R1 but with a stage of quality audio amplification to increase the volume. AWT, \$11.65. Kit, \$7.75.

Model R3—Same as R1 but with two stages of quality audio amplification for loud speaker reception. Has special volume control and provision for C bias if power tube is used. THE BEST. AWT, \$13.75. Kit, \$9.25.

(Neat bakelite form plug-in coils are used instead of large sloppy coils with wire leads that are easily broken! Best results!)

SPECIAL!

The latest ROYAL Short Wave Receiver wasn't finished in time for us to give a full description and illustration in this issue. It's a positive knock-out! Uses a 233 two-volt screen-grid and a 233 Pentode tube. This combination in a perfected circuit gives amazing volume with extreme sensitivity! Loud speaker reception of many stations is possible. Needs only two dry cells, a 9 volt C battery, and three 45 volt B batteries. Tunes 14 to 200 meters. (500 Meter coil 75c additional.) Also supplied in special "Ham" type with the 20, 40, and 80 meter bands widely spread. State choice when ordering. Guaranteed to out-perform many higher priced sets! Model RR—\$13.95. Also in KIT form for those who like to "Roll their own". Complete with all necessary parts including instructions. \$9.95.

SPECIAL!

SPECIAL!

TRANSMITTERS

You can work these transmitters with dry cell tubes with batteries, up through receiver tubes with "B" Eliminators, to a real 210 power tube with one of our high-power transmitting power supplies and obtain amazing results all the way. Heavy copper tubing inductance, good quality variable condensers (add \$1.90 each if you wish Cardwell Condensers), heavy transmitting grid leak, special choke, large porcelain stand-off insulators, resonance indicator, sockets, condensers, dials, hook-up wire, etc., make these transmitters the finest money can buy! Puts out a strong, steady signal that will carry all over the world. Get "On the Air" NOW with a real outfit and experience a new thrill! Inductance supplied for 40 meter band. 80 meter band 50c extra. Simple attachment for phone transmission \$1.00 extra. Readrite meter 80c extra. Jewell \$5.00. (Meters not necessary for operation.)

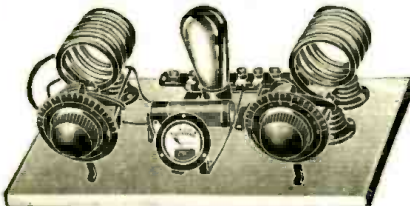

Model TS—An extremely simple transmitter to construct and operate. Only one dial to adjust. Uses the well-known Tuned Plate-Tuned Grid circuit noted for its stability. AWT, \$11.45. Kit, \$6.45.

Model TP—A standard TP-TG transmitter with more flexibility than the Model TS. Uses two variable condensers. AWT, \$12.95. Kit, \$7.95.

Model TH—Uses the famous Hartley circuit, a favorite with many. Most easily adjusted transmitter. AWT, \$12.45. Kit, \$7.45.

Model TP-P—The newly developed Push-Pull transmitter featured in Nov., 1930, issue of QST. Uses two as a single 210 with 600 volts and far steadier. For 245 tubes—AWT, \$14.95. Kit, \$9.45.

For UX-210 Tubes and all others. AWT, \$15.25. Kit, \$9.75.

Model T-75—An efficient 75 watt transmitter using an 852 type tube in a TP-TG circuit. Heavy copper strap inductances, 3,000 volt variable condensers, 6,000 volt Dubilier blocking condensers, etc. A real high-power outfit for consistent DX. AWT, \$36.95. Kit, \$18.95.

SPECIAL LOW POWER TRANSMITTER. Completely wired and tested! All you do is plug in tube and start sending. Uses any receiving tube. Complete with meter and resonance indicator. **Model TC**, \$9.95.

TRANSMITTING POWER SUPPLIES

These well filtered units will give your transmitter a pure DC note with a "Wallop" behind it! Contains heavy duty power transformer, large choke, high voltage condensers, sockets, cord and plug, etc. Delivers both filament and plate voltages. If desired in neat crackle finished metal cabinet add \$1.50 to kits and \$2.00 to AWT.

All operate from 110 volt 60 cycle AC house line. **Model PA**—Uses one 280 tube. Output is 300 volts DC at 50 MA, 7½ volts at 2 amp. (easily cut to 5 or 2½ V.) AWT, \$6.15. Kit, \$4.50.

Model PB—Uses one 280 tube. Output is 350 volts DC at 100 MA. 2½ V. CT—2A. 2½ V. CT—3A. 1½ V—8A. AWT, \$10.95. Kit, \$7.95.

Model PC—Uses one 281 tube. Output is from 400 volts DC at 75 MA to 700 volts at 40 MA. 7½ V CT—2A (2½ V—3A, 1½ V—9A, 50c extra). AWT, \$13.25. Kit, \$9.95.

Model PD—Uses two 281 tubes. Output is 500 volts DC at 125 MA. 7½ V CT—2½ A. 2½ V CT—12A. AWT, \$15.95. Kit, \$10.95.

Model PE—Uses two 281 tubes. Output is 650 volts DC at 170 MA. 7½ V CT—2½ A. 2½ V CT—12A. AWT, \$17.95. Kit, \$12.95.

Model PH—A 1,500 volt, 250 MA power supply for 50 and 75 watt transmitters. Especially recommended for use with the Model T-75 Transmitter. Also supplies filament of 10 volts at 8 amps. CT. Uses Royal high voltage filter condensers, Royal high-power transformer, heavy choke, etc. Takes two UX-866 Mercury Vapor rectifying tubes. (Not available in metal cabinet.) AWT, \$43.95. Kit, \$36.95.

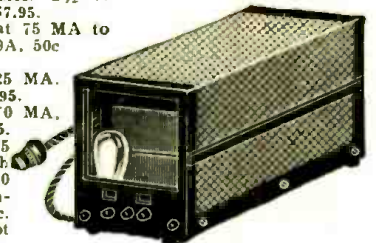

SHORT WAVE ACCESSORIES

To insure the maximum results from your receiver and transmitter we advise the use of our SPECIAL SHORT-WAVE TUBES. Every one is tested in a short-wave receiver or transmitter. RCA Licensed. Free replacement for 15 days. UX-201A, 40c. UX-199, 95c. UX-210, \$2.95. UX-230, 231, 237, 85c. UX-232, 233, 235, 236, 238, \$1.10. UX-245, 55c. UX-247, \$1.20. UX-250, \$2.05. UX-280, 60c. UX-281, \$2.45. UX-866, \$4.50. Sensitive 2,000 Ohm headsets, \$1.40. Baldwin Loud Speaker Units, \$1.45. Phone Plugs, 25c. Antenna Kits, 95c. High Grade Batteries: Dry Cells, 35c. 4½ Volt C, 35c. 22½ Volt C, 85c. 45 Volt Standard B, \$1.40.

All of our Short Wave Apparatus is designed by Government licensed short wave operators with a vast experience in this field.

20% DEPOSIT REQUIRED WITH ALL ORDERS.
Foreign Orders should contain full remittance plus transportation.

Harrison Radio Company

189 Franklin Street Dept. C-4 New York City

TRANSMITTING SETS



We have the latest and best! The sets have heavy copper tubing coils already wound (for 80- and 40-meter bands; 20-meter coil, 50c extra), best variable condensers, special transmitting choke and heavy-duty gridleak, fixed condensers, sockets, dials, good panel and sub-panel with aluminum brackets, hookup wire, all hardware, etc.—everything you need to build the set complete. Transmits all around the World! Latest Circuits! FULL INSTRUCTIONS, with numerous hookups of rectifiers, filters, power supplies, transmitting aerials, etc., etc. Sets will work with dry-cell, tubes and batteries (range 500 to 1000 miles on low power) at first, or larger tubes up to a 210, or even 2, 210's or 45 tubes in parallel! (50 watts!) Hookups supplied so you can use AC tubes (no batteries!), if desired. Attachment for phone transmission, \$1 extra. Plate Meter, 90c extra (though not necessary for operation). Get a good-looking panel-mounted set that looks business-like. MODEL A TRANSMITTER: Single-Control Transmitter. Works on either 40 or 80 meters without changing coils! (This feature alone beats any other set!) Uses famous T.P.T.G. circuit. A neat panel-mounted job. Kit, \$6.25. Same set for baseboard mounting, \$5.95. MODEL B TRANSMITTER: Uses Hartley Circuit. Famous all over the World. Kit, \$6.95. We will ship either of above sets already assembled and tested for \$5 extra for shop work. Nickel-plated "Mike" with special hard rubber handle, \$5.95. Filament transformer for AC operation, \$3.25. 1/2-in. copper nipples, sealed in end of pc. of 3/4" glass tubing, 5" long; fine for stand-off insulators, variable gridleaks, etc., 20c ea. Type 45 transmitting Tubes, \$1.25.

hookup wire, all hardware, etc.—everything you need to build the set complete. Transmits all around the World! Latest Circuits! FULL INSTRUCTIONS, with numerous hookups of rectifiers, filters, power supplies, transmitting aerials, etc., etc. Sets will work with dry-cell, tubes and batteries (range 500 to 1000 miles on low power) at first, or larger tubes up to a 210, or even 2, 210's or 45 tubes in parallel! (50 watts!) Hookups supplied so you can use AC tubes (no batteries!), if desired. Attachment for phone transmission, \$1 extra. Plate Meter, 90c extra (though not necessary for operation). Get a good-looking panel-mounted set that looks business-like. MODEL A TRANSMITTER: Single-Control Transmitter. Works on either 40 or 80 meters without changing coils! (This feature alone beats any other set!) Uses famous T.P.T.G. circuit. A neat panel-mounted job. Kit, \$6.25. Same set for baseboard mounting, \$5.95. MODEL B TRANSMITTER: Uses Hartley Circuit. Famous all over the World. Kit, \$6.95. We will ship either of above sets already assembled and tested for \$5 extra for shop work. Nickel-plated "Mike" with special hard rubber handle, \$5.95. Filament transformer for AC operation, \$3.25. 1/2-in. copper nipples, sealed in end of pc. of 3/4" glass tubing, 5" long; fine for stand-off insulators, variable gridleaks, etc., 20c ea. Type 45 transmitting Tubes, \$1.25.

Delft All Short Wave Wavemeter



This wavemeter is simple to use and saves time in tuning in foreign stations. Look up the wavelength of station wanted, set wavemeter to this wavelength (marked on wavemeter dial), then tune receiver to the wavemeter. Any station easy to find. Not connected to set in any way, just brought near it. Nothing else needed to use it with your set. Tunes in 11 to 250 meters, so any station can be found. Accurate. Shielded. Calibration remains constant. Numerous other uses: Checking receivers, coil and condenser ranges, transmitters, etc. Absolute necessity to experimenters. Use it to demonstrate your sets. Works with any short-wave regenerative receiver like DELFT, Pilot, S.M., National, etc., etc. Works with battery or electric sets alike. Also works with adapters. Complete Wavemeter with plug-in coils, large accurate calibration chart and FULL INSTRUCTIONS. List Price \$15. Your Special Price Postpaid, \$8.95. Jobbers and dealers see us. HAM-BAND Wavemeter. Looks like above meter, 1/2" of 1" accuracy. With calibrated coil for any one Ham band, \$6.95. For each extra band desired, add \$2.00.

COIL WINDING SET



Makes latest low-loss accurately-spaced short-wave coils. Set includes special collapsible accurate turn-spacing coil-winding form and all necessary forms, etc. for making finest coils money can buy! Also FULL INSTRUCTIONS showing all coil and condenser sizes for any short wave. Nothing else to buy. Complete, \$1.89 Postpaid. . . . Short-Wave Tuning Condenser (.00015 mfd.) \$1.35. Regeneration-Control Condenser, \$1.25. . . . Experimenter's Surprise Packages of Used Radio Parts: Pkg. No. 1, \$1.49 postpaid. Pkg. No. 2, \$2.49 Postpaid. Includes parts worth many times this price!! Low-Loss, 2-in. diam. coil stock, already wound, 2c per turn.

Get Complete Plans and Descriptions how to make them, of different Radio Prospecting methods. Many pages of diagrams, useful information (by A. Himmeweg), \$2.00. . . . We carry the famous line of SARGENT SHORT-WAVE CONVERTERS AND SUPERHETERODYNE RECEIVERS. Do you want something fine in S-W Converters? Looks like midket receiver, contains own power. No messy wires. Best in the country. Price, \$69.95 with tubes. Write for description of this fine line. . . . Used DC Broadcast Receivers, perfect condition, \$5 each. Latest Natural Tone Code-Practice Set. Uses '99 tube. 2 dry cells run it. \$3.85. Tube: \$1.25. . . . 4-Prong S-W tube-base, plug-in coils, set of 3 (115-125 meters) for .0001, .00015 condenser; for detector, \$1.50 for R.F. Amplifier, \$1.25. S-W hookups FIVE with a set of coils. . . . Send few stamps for catalogues. . . . S-W Adapter Kit, AC or DC, \$5.95. Complete. Two per cent off for cash in full. Foreign Orders Cash. If C. O. D. send \$1 Bill or stamps, pay rest to postman when delivered.

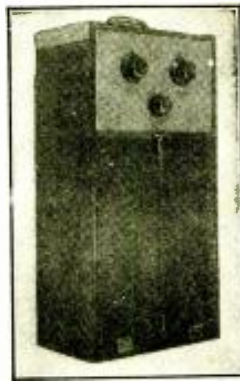

This 2-Tube Portable Receiver

can be used for ANY purpose. Light in weight. Complete in itself. 1000 miles on small aerial! Extras slip inside case. Uses 2-volt tubes and PEN-TODE TUBE. Size: 8" x 18" by 5" deep. Gets ANY short wave! Complete Kit (plug-in coils, case, — everything!) \$18.00 with tubes. Full Instructions. Nothing like it on the market!!

NEW SHORT WAVE RECEIVERS!

All-Electric or Battery Sets Using Pentode Tubes!

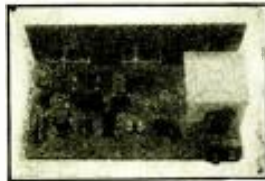

These Modern Short-Wave Receiver Kits use the new pentode tubes! Remember: a pentode tube costs no more but gives the volume of two ordinary tubes!! The set has to be specially designed to use this tube too! Guaranteed to outperform anything on the market! Brand new and up-to-the-minute, yet the lowest in price on the market! These sets get everything that can be picked up on short waves—broadcasting, U. S. and foreign, code, music, Television, etc. The Kits furnish ALL PARTS, panels, baseboard, all hardware—everything to build the set. You can use any kind of batteries or tubes. AC Kits also listed below. A fine coil winder also furnished so you can make coils to cover any wavelengths at all, as well as any extra coils you may need for R.F. amplifiers, etc. All sets listed below are similar to photos. One Tube Receiver with Special Sens-itive Circuit. Note: This little set is BETTER than any other because it can be used as a separate one-tube set or as an adapter just the way it is, and also as a superheterodyne converter of the latest design by building a simple oscillator to it. Full Instructions. Kit, \$5.95. Set Complete, \$7.45. AC Kit, \$6.45. Two-Tube Set using new Pentode Kit, \$8.95. Set, \$11.50. AC Kit, \$8.95. Three-Tube Set using new Pentode (works speaker). Kit, \$8.50. Set, \$13.50. AC Kit, \$10.50. Our coil winder makes coils that give results equal to an extra tube! These sets PERFORM! Easy to Build! . . . Four-Tube Set: one stage of tuned R.F., detector, audio and pentode in last stage. A Universal Short-Wave and Television Receiver. Kit, \$15.00. AC Kit, \$17.50. (A 4-tube with a Pentode works like a 5-Tube!) Filament transformer for AC Kits, \$3.25 (will light 7 AC tubes if desired). New 2-volt dry-cell tubes, \$1.30 each. Fine headphones, \$1.95 pr. AC tubes, \$1 each.

Add Tubes Ahead of Your Present Set and Increase your Distance Thousands of Miles!



These Sets Can Be Added Ahead of ANY S.W. RECEIVER. A DAPTER OR CONVERTER!

(AC or DC) You get ALL PARTS (Plug-in Coils—everything!) Full Instructions. No New Power Packs or Batteries necessary for any of the sets below because ALL PLATE POWER COMES FROM YOUR PRESENT SET! Easy to assemble. For Light-Socket Operation: (Type '21 s.z. tubes). One-Tube Kit for baseboard mounting (1-tuned R.F. stage), \$4.95. Same but TUNED R.F. STAGE, also for panel mounting, \$7.95. Two-Tube Kit, \$9.45. For Battery Operation: (Use dry-cell or s.z. tubes type '99), same as above AC Kits, but \$1 less in each case. Filament Transformer for A.C. Kits, \$3.25. Prices, less tubes.

next soldered to the other binding post B4. A long supply lead is also soldered to this post.

The receiver is now turned over, and a lead soldered to the junction of the antenna series condenser C3 and the antenna resistor R1. This lead should be of sufficient length to reach the control grid of the R.F. tube, and provided with a control grid-clip. The lead for the control-grid of the pentode also gets a clip.

The coils are of simple construction, and are wound on tube bases; three are employed for the short-wave band. The tabulated data are given in Fig. 3, along with the proper connections of the windings. For those who desire operation of the receiver from the A.C. line, a simple power supply unit is given in Fig. 4.

Parts List

- One—Hammarlund Type ML 5 short-wave condenser (C1)
- One—Hammarlund Type ML 11 short-wave condenser (C2)
- One—Hammarlund Equalizer condenser, 32 mmf. (C3)
- Two—Sprague or Aerovox tubular bypass condensers, 0.1 mf. capacity (C4, C5)
- Two—Sprague or Aerovox tubular bypass condensers, 0.5 mf. capacity (C6, C9)
- One—Aerovox moulded mica condenser midjet type, .00015-mf. (C7)
- One—Aerovox moulded mica condenser, .02-mf. capacity (C8)
- Two—Lynch metallized resistors with pigtailed, 1 watt, 100,000 ohms (R1, R4)
- One—Lynch metallized resistor with pigtailed, 1 megohm, 1 watt (R5)
- One—Lynch metallized resistor with pigtailed, 6 megohm, 1 watt (R3)
- One—Lynch metallized resistor with pigtailed, 1500 ohms, 2 watt (R6)
- One—Electrad 500-ohm pigtail grid-suppressor resistor (R2)
- One—Electrad 0-50,000 ohm bakelite shell Supertonatrol (R7)
- One—Bryant Electric switch, power type, single pole single throw two position (obtainable from Blan the Radio Man, Cortlandt St., N. Y. C.)
- One—Eby wafer socket, type 236 (V1)
- One—Eby wafer socket, type 237 (V2)
- One—Eby wafer socket, type 238 (V3)
- One—Pilot moulded bakelite socket, type 216 (V4)
- One—Pilot 80-millihenry R.F. choke
- Four—Pilot binding posts (B1, B2, B3, B4)
- Two—Sheets aluminum 1/4 inches long by 3/4 inches wide by 3/64 inches.
- Two—Sheets aluminum 8/4 inches long by 5/4 inches wide by 3/64 inches.
- Two—Sheets aluminum 5/4 inches long by 4 inches wide by 3/64 inches thick
- Four—Aluminum Corp. of America aluminum corner posts 5/4 inches long tapped for 6/32 screws.
- Three—Hammarlund screen-grid tube shields (V1, V2, V3)
- One—Coil shield can 3 inches diameter by 4 inches high
- One—Bakelite or hard-rubber panel 1 1/4 inches by 2 inches by 3/16 inches.
- Two—National type C vernier dials (C1, C2)
- One—236—One 237—One 238 automobile tubes. (Arcturus used in tests.)

DELFT
Phone: Higate 0748

DELFT RADIO
524-C Fairbanks Avenue
OAKLAND :: CALIFORNIA

SHORT - WAVE RADIO SPECIALISTS

The A.C. Superregenerative

By CLIFFORD E. DENTON

(Continued from Page 265)

their respective coils. The upper right-hand knob controls R2, which is insulated from the panel and varies the voltage on the oscillator's plate; the lower knob, governing R1, which is also insulated from the panel, controls the screen-grid voltage of V1.

Varying the Suppressor-Frequency

The switch Sw. which cuts in or out the condenser C3 shunting L3, changes the frequency of the local oscillation. With the parts utilized, the oscillating circuit works at the natural frequency of the transformer (30 kilocycles) when C3 is out of circuit; when it is cut in, its capacity of .001-mf. tunes the oscillations to 21 kilocycles. In Table I, the values of C3 corresponding to various suppressor frequencies, and the signal frequencies to which they are best adapted, are shown as computed on this basis. With other specifications of L3, of course, capacity values will change in inverse proportion to the inductance comprised. (See "How to Figure the R.F. Coil Secondary," by the author, beginning on page 37 of the July, 1931, issue of *Radio-Craft*.)

It is even possible for the ingenious constructor to use a fan switch, or condensers fitted with plug-in terminals, to approximate most closely the optimum suppressor-frequency over the whole range of the receiver's tuning.

The base is drilled for the 5-prong detector socket V1; the 250-millihenry R.F. choke RFC; the equalizing condenser C4; the bypass condenser C5; the A.F. transformer T; the oscillator socket, V2; the A.F. socket, V3; the pentode socket, V4.

The A.F. coupling condenser C10 is bolted to the base. The condenser bank with five 1-mf. units, C6, C7, C8, C9, C12, is placed in the center; with the voltage divider resistor R8 held in place, by bus-bar connections to the condenser bank. Mounting C11 near socket V4, and the oscillator coil L3 near V2, completes the layout.

Wiring and Operation

The filaments are wired in first, running the twisted leads under the chassis. All other leads are run in the most direct manner, depending upon the design of the parts used, and their placement. The center-tapped resistor R6 is soldered to socket V4, and the resistors R3, R4, R5, R7 are soldered to their respective terminals, becoming self-supporting.

Little more need be said; as the illustrations show the simplicity of the whole design and wiring.

The leads to the plug-in R.F. coils should be left just long enough so that the metal cover can be removed to replace tubes, when required. Do not depend upon the metallic connection between shields at this point for grounding. Run wires to all grounded parts, especially between tuning coils and condensers.

Hum and other local disturbances seem low in comparison with the signal level,

and the high signal-noise ratio is an excellent condition in a short-wave receiver.

More letters covering experiences with the super-regenerative circuit are invited; and, if questions do not come too fast, and are accompanied by stamped and self-addressed envelopes, the author will endeavor to answer them.

List of Parts Used

Two Hammarlund "MLW-125" 125-mmf. short-wave condensers, C1-C2, and two Kurz-Kasch vernier dials:

One Hammarlund 14-to-110 meter "Model LWT-4" short-wave kit, L1;

One Hammarlund 14-to-110 meter "Model LWT-4" short-wave kit, L2;

One Hammarlund "Type RFC 250" 250-mh. R.F. Choke, RFC1;

One Hammarlund "Type EC 80" 80 mmf. equalizing condenser, C4;

One Plechthelm filter block (five 1-mf. units), C6-C7-C8-C9-C12;

One Ferranti "Type AF-5" 3.75-to-1 ratio audio transformer, T;

One Sangamo .002-mf. double fixed condenser unit, C5-C13;

One Aerovox .001-mf. fixed condenser, C3;

One Sangamo .006-mf. fixed condenser, C10;

One Aerovox 25-mf., 25-volt dry electrolytic condenser, C11;

Two Electrold 50,000-ohm "Super-Tonatrols," R1-R2;

Two Electrold 20-ohm V-type resistors, R6-R9;

One Electrold 500 ohm wire-wound grid resistor, R3;

Two Durham ½ meg. 7-watt resistors, R4-R5;

One Electrold 400-ohm wire-wound grid resistor, R7;

One Electrold "R 71" 13,000-ohm voltage divider, R8;

One Carter battery switch;

One Acme 30 kc. I. F. transformer or equivalent (see preceding article for other options), L3;

Four Pilot UY (5-prong) sockets, V1-V2-V3-V4;

One Yaxley 7-wire cable, 3-4-5-6-7-8;

Two Eby lettered binding posts, 1 and 2;

One output connection block, 9-10;

One aluminum cabinet 7x9x18x3/32" thick;

Miscellaneous hardware (two National screen-grid clips; screws, nuts, lock-washers, wire, etc.).

Data for the coils L1 and L2 were also given in the Oct.-Nov. issue of *SHORT WAVE CRAFT*.

Another alternative is therefore given here. Take a Silver-Marshall "130 T" coil form (1 inch in diameter, 2½ inches long, with 98 threads in the winding space) and wind on it 630 turns, in seven layers, of No. 32 D.C.C. wire, for the secondary or grid coil. Over this, at the lower end, the pickup coil L3 is wound—100 turns of No. 38 enamelled wire. Do not bank-wind.

The tickler or plate coil is 300 turns of No. 38 enamelled, wound into the small slot which is cut into the base of the coil form for the purpose. The form is made to plug into a regular UY socket, for ease in connection.

With a shunt capacity of .001-mf., the secondary will then tune to about 45 kilocycles, suitable to an ultra-short wavelength; and higher capacities will lower the frequency in proportion to the square roots of their value—as indicated in the table, which was made for a transformer of much higher inductance. For the coil just described, the capacities needed will be in the order of .01-mf. at 20 meters; .05 at 40, and 0.2 at 80 meters.

YOUR FUTURE IN RADIO



... prepare for it at
RCA INSTITUTES

RCA Institutes . . . America's oldest radio training school, founded 22 years ago . . . offers ambitious men elementary and advanced courses in many branches of practical radio. RCA Institutes is directly associated with the most complete research laboratory in the radio industry.

Modern equipment. Instructors of practical experience. Four resident schools—New York, Chicago, Boston, Philadelphia. Enroll any time. Courses starting every six weeks. Also extension courses for home study, with free scholarships for outstanding graduates. Tuition moderate. Investigate today.



A Radio Corporation of America subsidiary

RCA Institutes, Inc., Dept. SWC-12
75 Varick St., New York, N.Y.

Gentlemen: Please send me your General Catalog. I am checking below the phase of radio in which I am particularly interested.

Aircraft Radio
 Broadcast Station and Studio
 Television

Talking Pictures
 Recording on Disc and Film
 Servicing Home Entertainment Equipment.

Name.....
Address.....
Occupation..... Age.....

Proven Television NOW



ONLY
\$19.75

Price of scanning
disc alone \$2.50

SEE-ALL Televisor Kit

No need to wait any longer to enjoy modern television when SEE-ALL offers proven equipment at such low prices.

Less than 20 minutes
required to assemble it.

All essential parts and simple instructions to assemble a fool-proof televisor included.

SEE-ALL Short-wave Receiver lists for \$39.50 less tubes.

At your dealers
otherwise send purchase price
for delivery postpaid.

TELEVISION MFG. COMPANY
OF AMERICA, INC.
5 UNION SQUARE NEW YORK CITY

The Largest Variety of Tubes in the World!

PENTODES — SCREEN GRIDS — AMPLIFIERS — VARIABLE MUS — DETECTORS — POWER — TELEVISION — PHOTOELECTRIC CELLS — RECTIFIER AND CHARGER BULBS, ETC.

30-Day Replacement on Every Tube!

All tubes are guaranteed to be first-grade quality

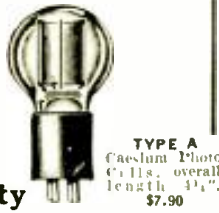

TYPE V
Television Tube, 1 1/2" square cathode, overall size 2"x2". . . \$3.85



TYPE X
Television Tube 1" square cathode, overall size 1 1/2"x3/4". . . \$3.85



TYPE O
Potassium Photo Cell, 1" overall. \$3.85



TYPE P
Caesium Photo Cells, overall length, 3 1/4". \$5.90

All tubes are guaranteed to be first-grade quality—comparable to the best obtainable on the market today. We will replace within 30 days any tube that has not given complete satisfaction.

Such an amazing tube sale has never been conducted.

COMPLETE STOCK ALWAYS READY FOR IMMEDIATE SHIPMENT

Order from this page and note the following terms: No order accepted for less than \$5.00. It is not necessary to send the full amount of cash with the order as long as your order is accompanied by 20% of the value. Shipment will go forward to you by express or parcel post C. O. D. All prices are F. O. B. Factory, Newark.

UX-201A30	Special radio frequency 201A—a super-sensitive 201A.....	.60
UX-22630	Special radio frequency 201A—a super-sensitive60
UY-22730	Special 171AC 1-2 amp. extra coated filament60
UX-171A30	T-14 (210A High Mu) high emission Switch tube, 201A or 112 or 171 double life—all in one60
UX-17130	Adapter tube 226, 227, 171 A, to convert bat. sets to AC, each.....	.60
UX-24040	UX-210—For power amplifier	1.10
UX-12040	UX-250—Power amplifier	1.10
UV-19940	Ballast tube	1.00
UX-199, Standard Base40	UX-222—Screen grid	1.10
UX-19940	Photoelectric cell "Caesium." Size overall 4 1/4"	7.90
UX-11240	WD-11—Detector Amp.60
UX-112A40	WD-12—Detector Amp.60
UX-200A40		
UY-22440		
UX-24540		
Quadrode 5-prong 201A for special circuits60		
Special detector tube 200A—a super-sensitive detector60		

RECTIFIER AND CHARGER BULBS

125 Mil. rectifying tube (B. H. type).....	\$1.40
6/10 amp. trickle charger bulb.....	2.00
2 amp. old and new type charger bulbs (list \$4.00), our price (Tungar Type).....	2.00
5 and 6 amp. old type charger bulbs (list \$8.00), our price (Tungar Type).....	3.75
UX-280—Used as a full-wave rectifier for high emission40
UX-281—Half wave rectifier.....	1.10
Rectifying tube especially designed for use with Freshman Master "B" Eliminators UV brass base, limited quantity.....	.30
UX-866—Half-wave Rectifier mercury vapor.....	5.00

DISCOUNTS: 100 tubes and over 10%. 500 tubes and over 10% and 10%

NEW TYPE TUBES

UY-236—Screen Grid Radio Freq. Amp.85
UY-237—Detector Amplifier85
UY-238—Power Amplifier Pentode85
UX-280—Dry Cell amp. and detector60
UX-231—Dry cell amp.60
UX-232—Dry cell screen grid amp.60
UY-247—Power pentode85
UY-235—Super control screen grid amp.85
UY-551—Variable Mu85

ARCO TUBE CO. 38-40 Park Place, Newark, N. J.

How High Is That Balloon?

By CAPT. JAMES A. CODE, JR.

(Continued from page 248)

The transmitter is so attached to the balloon that the supporting and trailing wires constitute an antenna and counterpoise, and act as two legs of an ideal dipole radiator. The frequency radiated depends on the length of the legs chosen in conjunction with the circuit inductance, and the length of these legs is arbitrarily chosen as 40 feet; which determines the wavelength at about 125 meters. The length is not critical, however, and the legs may be shortened or lengthened as desired. One leg may even be omitted entirely; and then the frequency, as determined by the capacity of a single wire, is sufficient to maintain effective oscillations at a much shorter wavelength.

Signals Heard Eleven Miles

The transmitter signals are readable up to 11 miles and, with a fresh battery, the transmitter will operate from 3 to 5 hours.

When actual balloon tests are made, the transmitter is first adjusted on a test stand, immediately before the balloons are released, and it is kept operating until it is removed for attachment to the upper antenna leg which holds the balloons captive. The transmitted signal is a clear, musical note, of a tone-modulated continuous wave. The entire signal energy is confined to a narrow frequency-band and, since no carrier wave exists in the system, heterodyne reception is resorted to after the balloons have travelled two or three miles and the signal has become weak. The result gives the signal a hissing sound which is readily distinguished.

The direction-finding receiver is portable. It covers a band of frequencies higher than the broadcast band and employs tuned, single-control radio amplification; the controlled regeneration is confined to the detector, so that C.W. signals may be received. The input employs capacity neutralization to eliminate the antenna effect, and an aperiodic loop is used.

Consideration was given to the problem of constructing three-dimensional direction finders; since this would permit direct determination of the angle of elevation of the balloons, which is obtained with the visual theodolite method. It would appear that a combination loop and dipole, rotatable about a vertical and horizontal axis, would solve the problem; but, since the capacity to ground of the dipole is more difficult to correct than that of the loop, the idea has been dismissed for the present. Instead, it was decided to rely upon giving the balloons the proper inflation to determine the elevation by their ascensional rate, and to construct a simple direction finder. The finder as developed serves the purpose extremely well, and is correct to within one-half a degree.

Special NET PRICE LIST

MICROPHONES

No. 300 Single Button Carbon Type Stretched Diaphragm	\$ 9.00
No. 301 Two Button Carbon Type Stretched Diaphragm	15.00
No. 302 Two Button Heavy Duty Type.....	30.00
No. 303 Two Button Concert Model.....	45.00

Hand Types, also Condenser Types now in fabrication.

MICROPHONE REPAIRS

Any Two Button Microphone reconditioned at net each (any make).....

MICROPHONE INPUT TRANSFORMERS

No. 410 For Single Button	\$ 2.50
No. 510 For Two-Button	3.25
No. 310 For Two-Button HEAVY WORK in both 100 and 200 Ohms.....	9.00

Also send for Price List and Catalog A of other Public address equipment and complete public address systems.

MILES REPRODUCER CO.
26 East 22nd St. New York

You Can Become a Fast Capable RADIO OPERATOR at HOME



By **CANDLER**
Scientific Method

In less than half time required by any other. Nothing like it. Amazing results. FREE ADVICE if you're "stuck." Thousands fast Radio operators taught by CANDLER, world's only Code Specialist. FREE BROCHURE will save you time and money. All questions answered personally. No obligation. If Radio operator, ask about ADVANCED COURSE for SPEED and Copying Behind, and "MILL" Course.

Candler System Station for our Students now on the air.
THE CANDLER SYSTEM CO. Dept. SW-4
6343 So. Kedzie Ave., Chicago, Ill.

Whatever
your **HOBBY!**
you'll find it in

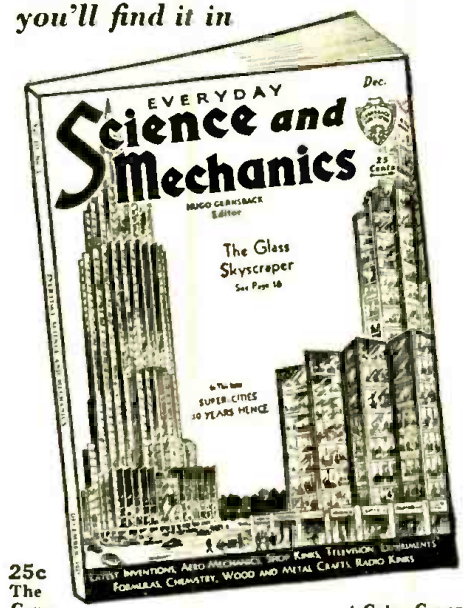

25c
The
Copy

4-Color Cover
Over 100 Illustrations
96 Pages—9x12 inches

MR. HUGO GERNSBACH's latest magazine contains the most important and recent developments in Science, Mechanics, Radio, Television, Aviation and Chemistry. For everyone, regardless of age, EVERYDAY SCIENCE AND MECHANICS will be found to be useful and instructive. Thoroughly illustrated with scientific events from all parts of the world, and helpful to thousands of high school, university students and instructors who wish to advance their scientific knowledge.

Many excellent pages for the home workshop man who finds pleasure in building things; experiments in electricity, chemistry and formulas of all kinds.

Just to Mention a Few Departments

- LATEST INVENTIONS
- AERO-MECHANICS
- SHOP KINKS
- TELEVISION
- EXPERIMENTS
- FORMULAS
- CHEMISTRY
- WOOD AND METAL CRAFTS
- RADIO KINKS
- AND OTHERS

Special Offer!
8 Months for \$1.00

On All Newsstands
NOVEMBER 1st
Mail Coupon NOW!

EVERYDAY SCIENCE AND MECHANICS
98 Park Place, New York, N. Y. SWC-12

I enclose herewith One Dollar for which you are to enter my subscription to EVERYDAY SCIENCE AND MECHANICS for the next Eight Months.

Name

Address

City State

A Short-Wave Super-Converter That's Different

(Continued from page 260)

"self-contained" power supply. (This converter is supplied in kit form; and also completely wired, at small additional cost.

The converter consists of a tuned detector, using a '24 tube, in conjunction with a '27 tube in a specially-designed oscillator circuit, and an '80 type rectifying tube. The power supply operates from any 100-120 volt, 25-60 cycle circuit or (by quick change of two power-transformer leads) from any 200-240 volt, 25-60 cycle alternating current lighting circuit; and provides all "A," "B," and "C" power for the converter. The converter comes wired for operation on 100-120 volt 25-60 cycle current.

Performance of this "Super-Het" Converter

The converter designed by Mr. Silver, operated in combination with any standard broadcast receiver (either of the T.R.F. or the super-heterodyne type) which has a normal amount of sensitivity, makes a short wave super-heterodyne which will give *loud-speaker reception* of short-wave phone and short-wave broadcast programs of practically all American short wave stations and most foreign ones.

The antenna lead should be removed from the broadcast receiver and connected to the antenna binding post at the rear of the converter. The shielded wire coming out of the converter should be connected to the antenna binding post of the broadcast receiver, and the wire connected to the shielding on this lead connected to the ground post on the broadcast receiver. Insert the power cord of the converter in the nearest light socket, and the converter is ready for operation.

No "Squeal" Heard—A New Feature!

In tuning the converter, care should be taken to see that a short-wave station is not passed without noticing it. The short-wave detector is of the non-regenerative type, and no regenerative squeal will be heard. The dial should be rotated very slowly, and the compensating knob to the right of the dial knob frequently adjusted, to be sure that the receiver is operating at maximum sensitivity.

Correction Notice

In the last issue of SHORT WAVE CRAFT we published a table entitled "Don'ts for the Short Wave Listener" and we credited this to Philip's Radio, operators of station "PCJ", Eindhoven, Holland. We have been informed by Mr. A. J. Green, President of the International Short Wave Club of Klondyke, Ohio, that this list of "Don'ts" was originally prepared by them and we are glad to give them due credit.

YOU CAN'T SEE IT —BUT IT'S THERE!

No nearly imitative rearrangement of the design of the CARDWELL, the original metal end plate—grounded rotor condenser has ever matched the unique electrical efficiency of the genuine CARDWELL.

You Can't SEE It, But It's THERE

Enhancing its remarkable efficiency is the ruggedness and strength of the good CARDWELL. No dubious expedient making for cheapness of manufacture is employed, yet CARDWELLS cost you no more.

The CARDWELL featherweight "Midway," a pioneer in its class, is made in 13 sizes for transmitting, receiving and neutralizing. The 413-B, 150. mmfds., for 3000 volts, weighs but 7 ounces and occupies a panel space of only 3" x 2½", with the depth behind panel 4½ inches. Other sizes in proportion.

Send for literature describing a wide variety of transmitting and receiving condensers.

CARDWELL CONDENSERS

The Allen D. Cardwell Mfg. Corpn.
85 Prospect Street, Brooklyn, N. Y.

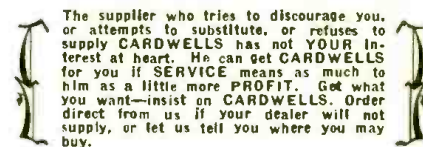

The supplier who tries to discourage you, or attempts to substitute, or refuses to supply CARDWELLS has not YOUR interest at heart. He can get CARDWELLS for you if SERVICE means as much to him as a little more PROFIT. Get what you want—insist on CARDWELLS. Order direct from us if your dealer will not supply, or let us tell you where you may buy.

"THE STANDARD OF COMPARISON"

SERVICE MEN

Send for this Book

FREE!



YOU NEED IT!

Everything for your business from the finest mike to the smallest screw is in this book.

GUARANTEED QUALITY GOODS

PRICES LOWEST EVER QUOTED

Fresh new dependable Merchandise at Bargain Prices!

Leading Manufacturers Lines Complete
Send For Your Copy Now!

HEADQUARTERS
for SERVICE MEN'S SUPPLIES

RADOLEK CO.

601 W. Randolph St.
CHICAGO
Illinois

USE THIS CONVENIENT COUPON

Radolek Co.,
609 West
Randolph St.
Chicago, Ill.

Please send me without obligation your Service Man's Supply Book.

Name

Address

City State



PRESTON DYNATRON OSCILLATOR

RADIO frequency circuits in both Tuned Radio Frequency and Superheterodyne sets must be adjusted to greater accuracy than is possible by the use of the broadcast wave. The Preston test oscillator covers the broadcast band from 550 to 1500 K.C. and instructions are supplied for testing and adjusting superheterodynes. The operation is very simple, and a calibration chart and wiring diagram is fastened in the cover of carrying case. Two tubes are used of the new '32 type. One acts as a radio frequency oscillator and the second tube is used to audibly modulate the radio frequency current generated by the first tube. Dry cells supply the current and a 5-prong plug and cable is furnished. The whole device is very simple and easy to operate. A valuable instrument for experimenters and custom set builders.

List Price \$20.00
SPECIAL TO EXPERIMENTERS.....\$16.75

Preston Output Meter for use with test oscillator. Used for trimming condensers, checking tubes by substitution, adjusting detector voltages and other adjustments.
 List Price\$7.50
SPECIAL TO EXPERIMENTERS \$5.50



Mail Remittance Directly to

The Beede Electrical Inst. Corpn.
 Penacook, New Hampshire
 Send for Bulletin S. W. 10

Gem Short Wave Unit for Local and Long Distance SHORTWAVE BROADCAST

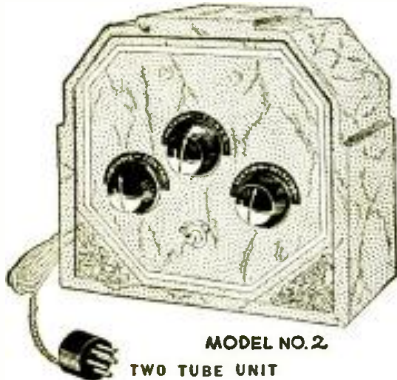

MODEL NO. 2

TWO TUBE UNIT

This unit including with plug-in coils ranging from forty to two hundred meters. The Short Wave Unit is universal, either for No. 227 or No. 224 Detector Tubes. Once this unit is attached to your radio, it can always remain. A switch on this unit is to cut on and off your regular broadcast reception. We guarantee Short Wave Broadcast in the United States and Canadian Stations. For foreign stations, if all is favorable, this unit will receive them with great clarity and volume.

Extra coils as low as seven meters can be obtained from us at a price of 50 cents each. Regular price of this unit is \$15.00, special for this issue only \$9.00 with money order accompanying coupon. 20 cents extra for postage anywhere in the U. S. A. and Canada.

NAME
 ADDRESS
 CITY

Essenbee Radio Devices Co.
 732 Mather St. Chicago, Ill.
 ERC

A New Converter of Novel Design

By **JAMES MILLEN**

(Continued from page 257)

when using the two '35 variable-mu tubes in the circuit, is of some advantage,

The filter comprises a small choke coil which, because of the low value of current drawn through it, can have an exceedingly small air gap and, consequently, high inductance without danger of saturation. On both sides of the choke are located 8-mf. electrolytic filter condensers. The power pack is entirely shielded from the detector and the oscillator circuits, by means of the welded-steel partition, running lengthwise along the chassis. The power transformer also supplies the necessary heater voltages to all five tubes.

The I. F. Amplifier

In order that the converter might be universal in its application to any type of broadcast receiver, a stage of high-gain I. F. has been incorporated as an integral part of the converter. Such an arrangement is the outgrowth of an idea originally suggested by L. W. Hatry, who will be remembered as the developer of the "HY-7" superheterodyne, described last year in SHORT WAVE CRAFT.

In addition to furnishing a voltage gain of approximately 100, this stage of amplification also serves as a low-impedance output, or coupling-network; so that the output lead from the converter may be connected directly to the antenna post of the broadcast receiver, without either making the set oscillate, or having the antenna coupling system of the set act as such an extremely low-impedance "load" on the output circuit of the first detector as to prevent an appreciable signal getting into the broadcast receiver.

The output lead, from the plate circuit of this I. F. tube to the antenna post of the broadcast receiver, is shielded in order to prevent pick-up of any local interference or low-frequency transmitting station. To further minimize the possibility of any such pick-up troubles, where the converter is used with an unshielded R. F. chassis, an I. F. frequency of 575 kc. has been selected.

Coils Selected by New Switches

Numerous methods have been suggested for eliminating plug-in coils for short-wave receivers and converters but, in the final analysis, it must be admitted that nothing has yet been recommended that approaches in effectiveness the 6-prong plug-in system. For purely converter use, however, where the number of coils to be switched in any one circuit are few, the system developed for the new "NC-5," illustrated herewith, has been found decidedly satisfactory. Perhaps one of the main reasons is the use of the new "R-39" molding material; which permits the many mechanical design tricks without the introduction of prohibitive electrical losses, which would be incurred should ordinary bakelite be used for this purpose.

NEWARK ELECTRIC Short-Wave Converter

New In Design: 15 to 200 Meters. World Wide Reception; Unlimited Range. Model 440, 4 Tubes \$34.50. Model 400, 3 Tubes \$29.50



The N. E. short wave converter operates with any make of radio. It merely connects to the antenna post of your receiver. Has self-contained power pack, no other connection, can be left connected permanently, has change-over switch for either short wave or broadcast reception. Model 400 three-tube for extremely sensitive receivers. Model 440 four-tube with R.F. stage for any type receiver.

Sent prepaid if check accompanies order: or C.O.D. with one dollar deposit.

NEWARK ELECTRIC CO.
 A Radio Service Institution
 229 West Madison St., Chicago, Ill.

YOUR NAME on the
VOTING COUPON
 —page 286—will help organize the
RADIO PHONE LEAGUE

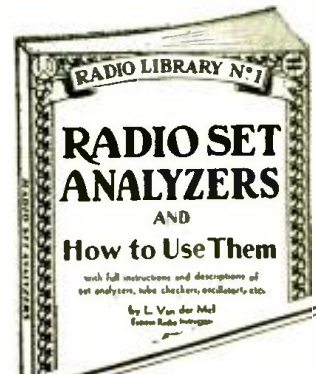

A Timely NEW Radio Publication

JUST OFF PRESS!

If you are a Radio Service Man or if you intend becoming one, this book is absolutely invaluable to you. It goes into every phase of testing and gives you the very information you have been looking for. It contains also complete description and hookups of important analyzers on the market. Fully illustrated with important diagrams, hookups and other illustrations. The only book of its kind in print.

Send fifty cents today for your copy

GERNSBACK PUBLICATIONS, Inc.

98C Park Place New York, N. Y.

The coupling transformers, working between the high-frequency pre-amplifier and the first detector, are truly transformers, with the primary interwound between the secondary in the fashion developed in connection with the "SW-5" short-wave receiver.

A mechanically-operated color screen on the drum-dial illuminator is driven by the same knob that drives the frequency-changing switch, indicates which coil is in use.

Economical Modulators for Amateur Transmitters

(Continued from page 270)

age of the normal gain through the tube will vary as shown in the curve. From this information we may calculate the percentage of modulation corresponding to a given modulation voltage. This latter curve, shown as Fig. 2, indicates that a signal voltage of only seven volts will provide for a modulation percentage of over 60, at which point the curvature of the characteristic becomes excessive. Now 60% modulation in an amateur transmitter, with little or no distortion, is nothing to be sneezed at; and the fact that a mere seven volts is required from the A.F. amplifier for maximum modulation means that a '27 or an '01A with a good impedance-matching transformer is all the modulator tube we require.

Fig. 3 is a schematic diagram of a small transmitter employing this system of modulation. The plate supply for such a transmitter will require but a single '80 rectifier, as employed in receivers using a '45 output tube. Where higher power is required, additional tubes may be added; or two '45s as "Class B" amplifiers may be employed in the output stage.

For the Advanced Amateur

For those advanced amateurs, for whom the power involved in the system above is too meager, the writer has a second message involving the DeForest 565 7.5-watt screen-grid tube used as a modulated R.F. amplifier. Curves involving the changing gain of the 565 tube (when it is provided with a screen-grid potential varying about a fixed value of 140 volts, a control grid bias of -30 volts, and a plate voltage of 450) indicate that linear modulation over a range of some 65 to 70% may be obtained with an A.F. signal of 45 volts.

For a modulator a '27 tube, resistance-coupled to the screen-grid lead of the 565 in the manner shown in Fig. 4, will serve our purpose admirably. In this case it will be necessary to work the '27 very close to its maximum capabilities, with a full 180 volts on the plate and a grid bias of 13.5 volts. The plate current of the '27 under these conditions is 5 milliamperes; a terminal voltage of 450 will be required to compensate for the drop through the 50,000-ohm coupling resistor and for the fact that the grid bias is taken through a 2,700-ohm resistor. The 565 screen-grid tube must be followed by "Class A" or linear amplifiers, or by "Class B" amplifiers in push-pull, if quality is to be maintained.

Arco New UX 866s, guaranteed 1000 hours...	\$ 3.35
Carrier screen-grid cap \$3.10 Also tube shield...	.60
Universal double button Hand-Mike microphone	8.90
Slightly used West. Elec. 212D tubes	\$35.00.
New ones	50.00
West. Elec. shielded three wire cable, cloth covered. Special per ft.	.10
Hardwick-Hindle 10,000 ohm 50 W grid leaks...	.50
Cardwell .00023 mfd. 3000 volt. Variable Condenser	3.25
Four gang .0005 variable condensers	1.80
Teleplex with 3 taps	13.00
Crosley double chokes, 175 mills.	1.75
Signal Corps panel mfg., 4 pole double throw switch	.60
Aerovox 8 mfd 500 volt, dry Elec. Cond.	1.18
1—Used National Radio Institute Course, special.	22.00
Arco 750 volt, and 7 1/2 volt, power pack, fully filtered	15.00
Victor ABC power transformers for that November, 1930, transmitter	2.45
Metal Monitor cans, 5 x 6 x 7, drilled, and removable cover	1.20
Latest Ward Leonard transmitting grid leak for 210, 211, 203A, 10,000 ohm	.90
Ward Leonard No. 507-37 grid leak for UX 852 tube	.80
Ward Leonard grid leak No. 507-51 for UV 204A	2.70
Ward Leonard grid leak No. 507-68 for UX 245	1.20
Aerovox .004 midjet fixed condenser	.27
Cardwell midway 105 mmdfd, Type 404B	1.40
Cardwell 15 mmdfd, balanced midjet condenser...	.75

RCA UX 250 new, original cartons	3.40
Genuine De Forest 510 tubes	5.20
New latest type R-3 rectobulbs, each	6.95
New type R-81 rectobulbs, each	3.50
New CoCo UX 866 tubes, unconditionally guar.	4.50
RCA UX 240 Hi-Mu tube	1.00
G.E. oil immersed filter condensers uncondi. guaranteed six months, slightly used.	
2 mfd. 20,000 volt, 2 mfd. 4000 volt, 3 mfd. 3500 volt, 5 mfd. 3300 volt, special, each	20.00
G.E. double 30 henry choke total 180 mills, special	2.10
20— or 40— or 80 meter band spread coils for National Sets, per set	3.75
Arco 50-watt sockets	.95
Arco 75-watt sockets	1.35
Arco 204A 250 watt sockets	1.95
Arco sockets for 212-A or D tubes	3.50
Arco 2 mfd. 1000 volt condensers	.70
Arco 3 1/2 mfd. 1000 volt condensers	.90
Arco 4 mfd. 1000 volt condensers	1.00

Above all unmounted but sealed in Paraffin.

Sturdy leads.

2 mfd. 1150 volt sealed in fiber box. Beautiful job	1.50
4 mfd. 1250 volt oil impregnated condensers.	3.25
All above condensers are working voltage not D.C. rating, Hi.	
Arco 1 mfd. 3500 volt transmitting filter condensers	9.50
Arco 2 mfd. 3500 volt transmitting filter condensers	14.00
Arco 1 mfd. 3000 volt transmitting filter condensers	8.50
Arco 2 mfd. 3000 volt transmitting filter condensers	12.50
Arco 4 mfd. 2000 volt transmitting filter condensers	9.50
Arco 8 mfd. 2000 volt transmitting filter condensers	12.50
Arco 16 mfd. tapped at 8 mfd. 1250 volts D.C.	8.50
Arco 1 mfd. 1500 volt condensers	2.90
Arco 2 mfd. 1500 volt condensers	3.50
Arco 4 mfd. 1500 volt condensers	5.75
All Arco high voltage condensers are guaranteed one year.	

600 Volts 800 Volts

1 mfd. \$.20	1 mfd. \$.30
2 mfd.25	2 mfd.40
3 1/2 mfd.35	3 1/2 mfd.50
4 mfd.40	4 mfd.60
Universal Microphones, Model BB	14.50
Universal Microphones, Model KK	28.00
Universal Microphones, Model LL	42.50
Universal Baby Mikes QRQ	2.85
Universal Baby Mikes with switch, 25 ft. cord.	4.30
Universal Hand-Mike	5.75
Arco calibrated Monitors with batteries, three coils and individual calibrated charts.	9.35
Arco calibrated wavemeters	6.25
Clarostat 250-watt primary rheostats, each	3.50

HERE'S ALL YOU NEED TO GET INTO THAT FREQUENCY MEASUREMENT CONTEST

Build that Dynatron Frequency Oscillator. We have everything.

2 Spool No. 30D.C.E. wire	\$.50
5 mfd. by-pass condenser	.30
1 .006 Sangamo condenser	.50
1 Weston Milliammeter 0-10 mills.	4.50
1 Five wire battery cable	.35
1 Gen. Radio 557 condenser	3.50
1/2" Bakelite form	.20
1 Vaxley 60 ohm rheostat	.60
1 Electrode 200 ohm potent.	.90
1 National Precision dial	3.75
1 RCA UX 232	.50
1 Rubber Panel, 7 x 9 3/16	1.38
The above job completely assembled and wired less batteries, including calibration with chart.	\$8.50 extra.

RCA Licensed 233 D.C. Pentode	\$ 1.65
RCA Licensed 247 A.C. Pentode	1.14
1 Used A.C. Pilot Suser Vasp with band spread	34.50
Genuine National .0005 23 plate var. cond., list \$5.00	1.65
RCA UX 210 new, original cartons	4.20

INCLUDE POSTAGE WITH ALL ORDERS AND 20% DEPOSIT AGAINST C.O.D. SHIPMENTS

Visit Our Radio Shack When In Town—Good Time Assured Hi—What Have You for Sale or Trade? Over 35,000 Square Feet of Space Devoted to Short Wave and Transmitting Apparatus. WE CARRY EVERYTHING FOR THE HAM IN STOCK MORE FOREIGN TRADE SOLICITED Open Evenings Write for free Ham Sheet

UNCLE DAVE'S RADIO SHACK

356 BROADWAY Long Distance Phone 4-5746 ALBANY, NEW YORK

REVOLUTIONARY

That describes this ultra modern short wave tuner—

The VARI-COIL

Gives you single dial control over a range 16 to 100 meters with perfect regeneration over entire scale. It uses the best of materials with sound engineering principles.

Write for information.

ARTHUR J. HURT & CO.
550 Clayton St., Denver, Colo.

Everyone Interested in SHORT WAVES should read the announcement on Page 286 of the new Radio Phone League

LEARN BY LISTENING Telegraphy

Morse or Continental

TELEPLEX is more than a machine—it is a SYSTEM. It teaches you expert sending and receiving, Morse or Continental Code—for amateur work

or a good-pay position. TELEPLEX is used by the U. S. Army and Navy and leading radio and telegraph schools.

Entirely NEW code course in 12 rolls of tape. During the last ten years, TELEPLEX has trained more operators than all other methods combined.

Write for Folder SW-6

Teleplex Co.

76 Cortlandt St., New York

Teleplex



Aluminum Box Shields

Beautiful Silver Dip Finish

- 5 x 5 x 5 Knocked-down
Coil Shield (like pictured
on right) 1.00
- 5 x 9 x 6.....\$1.87
- 6 x 10 x 7 Monitor Size... 3.25



We make any size to order.
Alcoa Shield Plate, 25c; 7x16 Aluminum Panel, 75c



"BUDDY" Test Prod

Always sharp pointed, using phonograph needles, 4 ft. wires, spade or phone tips. Colored nipples identify each lead.
75c each. \$1.50 per pair.
WE SPECIALIZE IN RADIO PARTS EXCLUSIVELY — parts furnished for any kit in any magazine.

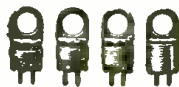

Short wave coils,
\$1.75

- .00035. Midget Cond. \$1.75
 - #0 Millihenry Choke..... .59
 - Pilot Coil Forms..... .35
 - 3 Gang, 4 Point Switch 2.25
 - 2 Gang, 4 Point Switch 1.65
 - Sponge Rubber Phone Cushions 50c pair
- Please include sufficient postage

BLAN, The RADIO MAN, Inc.
Dept. SWC 1231
89 CORTLANDT ST. NEW YORK, N. Y.

We carry a complete line of the following parts and units:

- | | | |
|----------------|---------------------|-----------------|
| Aerovox | Pilot | R. C. A. |
| Amerfran | Readrite | Peerless |
| Best | Signal | Farrand |
| B. & L. | Siemens-Halske | Oxford |
| Carter | Thordason | Eria |
| Clarostat | Tom Lab | Muter |
| Cardwell | Teleplex | Baldwin |
| Electrad | Elkon | Rola |
| Esico | Weston | Duo |
| Flechthelm | Sangame | Utah |
| Fleron | Yaxley | Magnavox |
| Franklin | American Microphone | Wright-Decoster |
| Hammarlund | Universal | TUBES |
| Harwick Hindle | Shallcross | R. C. A. |
| Jewell | SPEAKERS | Cunningham |
| Muter | B. B. L. | Tungsol |
| Marco | Bosch | |
| National | Jensen | |

WRITE IN FOR OUR PRICES ON THESE ITEMS
FLECHTHEIM METERS

- 0-300 DC volts.....\$1.95
- 0-500 DC volts..... 1.95
- 0-600 AC & DC volts..... 2.50
- High Tension Test Prods..... 35c
- Amplion Single Button Hand Microphone..... 3.95
- Hammarlund Variable Condensers—.0005......95c

- FARRAND INDUCTOR DYNAMIC SPEAKERS**
- 8-inch\$6.95
 - 12-inch 7.95
- R. C. A. Magnette Chassis.....\$2.75
Jensen—D-7 D.C. 110 v..... 7.95
Victor—D. C. Speaker..... 5.95
R. C. A. 106—A. C. Speaker..... 6.95
- Super-Peerless 12-inch A. C.—using Double Rectifier and Elkon Hum Condenser..... 10.95
Peerless D. C. 12-inch Dynamic Speaker..... 6.95
Oxford—14-inch Auditorium A. C. Speaker..... 12.95
Oxford—12-inch D. C. Dynamic Speakers..... 7.95
New Prime Motor—100 volt. A. C..... 6.95
Muter A. C. 10-inch Speaker..... 7.95
- We specialize in Amplifiers and Public Address Systems; also Transmitters. Send in your inquiries.

- CARTER RHEOSTATS**
OHMS
- | | | | |
|-----|------|--------|------------------------------|
| 1/5 | 25 | 2000 | All at One Special Low Price |
| 1/2 | 75 | 3000 | |
| 6 | 250 | 6000 | |
| 15 | 500 | 10,000 | |
| 20 | 1000 | 25,000 | |
- 25c ea.

- CARTER SHIELDED VOLUME CONTROLS**
OHMS
- | | | | |
|----|------|--------|---------|
| 5 | 100 | 2000 | Special |
| 10 | 200 | 5000 | |
| 20 | 500 | 10,000 | |
| 50 | 1000 | 40,000 | |
| | | | |
- 50c ea.

- CARTER SHIELDED VOLUME CONTROL with SWITCH**
OHMS
- | | | | |
|----|------|--------|---------|
| 5 | 100 | 2000 | Special |
| 10 | 200 | 5000 | |
| 20 | 500 | 10,000 | |
| 50 | 1000 | 40,000 | |
| | | | |
- 59c ea.

- CARTER SHIELDED POTENTIOMETER with SWITCH**
OHMS
- | | | | |
|-----|------|--------|---------|
| 100 | 1000 | 5000 | Special |
| 200 | 2000 | 20,000 | |
| 500 | 3000 | 40,000 | |
- 59c ea.

TRY-MO RADIO CO.
177 Greenwich St. New York City

The New Pilot All-Wave Receiver

(Continued from page 275)

from the ideal intermediate frequency for waves below 200 meters. The "All-Wave" was designed to use two I.F.'s so as to give maximum efficiency on both spectra. When the short wave section is used the antenna is coupled to the detector tuned circuit through a fixed condenser. The oscillator and detector circuits are magnetically coupled. Both circuits are tuned by a two-gang variable condenser with a small additional vernier across the detector tuning condenser to provide accurate tuning. This is especially necessary on short-wave sets where antenna constants and large frequency coverage make it almost impossible to absolutely align both detector and oscillator circuits with a ganged condenser.

The induced voltage from the oscillator mixes with the incoming signal in the grid circuit of the detector and the resulting beat, which is about 550 kc., is impressed across a circuit tuned to that frequency and transferred from there to the grid of the second '24 tube. This tube, which is a very efficient amplifier, is coupled to the broadcast section of the set through a fixed condenser.

A tuned plate oscillator is used in this section to secure maximum frequency stability.

The coils are located about the wave-changing switch so that the effect of any one coil upon any one other coil is negligible. The forms are so situated that three are mounted directly on the switch and two, covering the fourth and fifth bands, are mounted on top of the chassis, which thereby acts as a shield between the two sets of coils.

Switch Is Reliable

The switch itself is absolutely fool-proof and represents a very ingenious extension of the most common form of switch—the knife-blade type, the detector grid, the oscillator plate and the oscillator grid are the points that are switched.

Separate Power Supplies

Each section has its own power system and is adequately filtered so that there is no possibility of hum troubles. This separation of power systems allows for easiest serving and makes for greater simplification. Each section can be removed and inspected separately.

The spectrum between 10-200 meters is divided into five bands which allow for an unusually wide coverage. These bands are 10 to 19 meters, 19 to 35 meters, 35 to 65 meters, 65 to 110 meters, and 110 to 200 meters. There is, of course, generous overlap between bands.—*Radio Design.*

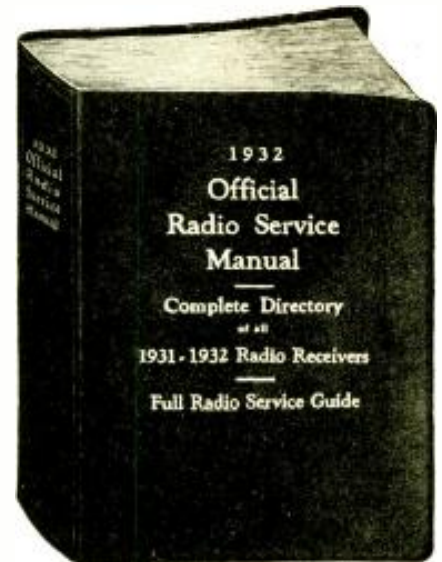

Difficult Problems in RADIO are Solved in the 1932 Manual

In all Radio history no book, so complete and thorough, as the 1932 OFFICIAL RADIO SERVICE MANUAL has ever appeared, wherein solutions of most complicated radio problems can be found, quickly and accurately. Every conceivable radio subject is carefully explained with illustrations and diagrams.

Briefly here is what is to be found in the 1932 Manual:

A step-by-step analysis in servicing a receiver which embodies in its design every possible combination of modern radio practice; it is fully illustrated and thoroughly explained. It is the greatest contribution to the radio service field.

Chart showing the operation of all types of vacuum tubes, whether new, old or obsolete. An exclusive resume of the uses of the Pentode and Variable Mu Tubes and their characteristics.

Complete discussion of the superheterodyne and its inherent peculiarities. Also a special chapter on tools used on superheterodyne circuits.

Schematic diagrams and circuits complete with color codings.

Important chapters on commercial aircraft radio equipment; new data on commercial short wave receivers and converters.

Servicing and installation of public address systems and talking machine equipment.

Standardized color codings for resistors. Operation of old and new testing equipment: tube voltmeters, output meters, oscillators and aligning tools.

A full section on Midget radios—their design, circuits and types. How to service them most economically.

Hundreds of schematic diagrams of older radio receivers which have never been published.

Blank pages for recording notes, diagrams and sketches; these pages are transferable to any part of the book.

OVER 1,000 PAGES

Over 2,000 Diagrams, Charts and Illustrations; Flexible Looseleaf Binder; 9x12 Inches; Complete Directory of All 1931-1932 Radio Receivers; Full Radio Service Guide; For Radio Service Men; Dealers, Jobbers, Manufacturers, Set Builders and Experimenters.

Clip Coupon NOW!

GERNSBACK PUBLICATIONS, Inc.
96-98 Park Place, New York, N. Y. SWC-12
Enclosed herewith \$5.00 (check or Money Order preferred) for which you are to send me One Copy of the 1932 OFFICIAL RADIO SERVICE MANUAL and the Supplements every 60 days, ABSOLUTELY FREE.

Name

Address

City State

Incorporate Companies

Organize, re-organize and arrange stock or bond issues. We help you raise working capital.

Write:

Bond House of Illinois
612 N. Michigan Ave., Chicago, Ill.

DEALERS WANTED EVERYWHERE

to sell
THE POLICE LOWWAVE CONVERTER

A new invention that is easily attached to any radio—by means of which anyone can tune in, at any time on local police broadcasting and get such thrilling—exciting—and often sensational—items as headquarters puts on the air for Radio-Police squads. Simple instructions are furnished.

Sells for Only \$3.00

Send \$1.75 for sample, no stamps. Or if you wish, send 10c in stamps for C.O.D. order and pay postman the balance of \$1.69.

Police Lowwave Laboratories
1460 Huron St. Toledo, Ohio

KNOW the EFFICIENCY of your tubes



Tests all tubes in general use—including the new Pentode and Variable Mu series. Uses only two sockets! By turning selector switch to designation on chart of type of tube to be tested, accurate readings may be made in a minimum of time! Correct readings for each type of tube are permanently indicated on the chart, as your accurate guidance.

Ideal for use by service men, dealers, experimenters and even for the consumer who wishes to test his tubes at home. The

The Price makes it possible for everyone to own. \$9.95
MADSEN INSTRUMENT COMPANY
98 Park Place, New York, N. Y.

Do You Tune or Simply Fish for Short Wave Stations?

INTERNATIONAL SHORT WAVE RADIO NEWS will bring you up-to-date schedules of Short Wave Stations throughout the World for 12 months for only \$1.00, single copy, 10 cents. In addition **INTERNATIONAL SHORT WAVE RADIO NEWS** will bring you all the important "dope" of happenings in Short Wave Radio everywhere.

Order Your Copies Today

INTERNATIONAL SHORT WAVE RADIO NEWS
Box 22, Boston, 30, Massachusetts
Jamaica Plain Station



SHORT WAVE IS HERE

New Adapter Fits Any AC Radio
New WORKRITE Adapter brings Police, Foreign, Airplane, Amateur, and leading U. S. Short Wave Stations, on any A.C. Radio. All wave lengths. Easily attached. Big demand. We guarantee it. Special proposition to live dealers and agents.

Write today to
TWENTIETH CENTURY CO.
1567 Coke Bldg., Kansas City, Mo.

All-Electric Single Dial Tuning, S-W Super-Het

By K. KONIG

(Continued from page 269)

screwed to the bottom with properly bent flanges; see Fig. 2.

On the under side of the subpanel (Figs. 4 and 5) we find the potentiometer P, whose center connection is bridged by the condenser C11, also the lead-off condenser C8 and the decoupling devices—R4 with C13, and R5 with C14. In fastening these parts one can often make use of the fastening screws of the parts mounted on the upper side of the subpanel. The metal cans of the block condensers are, as is seen in Fig. 4, grounded by a lug placed under the fastening screws; likewise the mounting angles W, and the already mentioned angle strips WS. The heater wires have holes drilled for them, so far as possible. On the side wall of the power unit we find six insulated terminals mounted. In Fig. 4 one of these practical terminals is drawn separately in an extra illustration. On the threaded part "s" are two insulating discs "a" and "b"; of which "b" extends into a corresponding hole in the metal plate with a cylindrical projection "i." According to the thickness of the metal plate used, one can adapt projection "i" to the thickness of the plate, using a file. The two hexagonal nuts hold "a" and "b" firmly against the plate; and the lead wire is put under the terminal screws.

The terminals of the A.C. power transformer marked "8 V" furnish an A.C. potential of 11.5 volts. The copper-oxide system Cu operates in bridge hookup as a full-wave rectifier, and is of suitable dimensions for an A.C. potential of about 12 volts, and a D.C. output of about 6 volts, at 1 ampere. "A" and "B" are the connections for the secondary side of the A.C. power transformer (8 V); C and D are the terminals for the direct current. An automatic switching device is AU, which, on the opening of the cover, cuts off the A.C. supply current. The device consists of two springs "f," which were taken from a commercial switch. The two springs are mounted on an insulating plate P1, which is fastened to the side wall by an angle mounting.

The second part of the switching device (Fig. 6), the contact closer, is fastened to the lid of the case at the right spot. It consists of an insulating plate P, on which there has been fastened by two screws S a properly bent strip K of spring sheet metal. Through holes L, in plate P, it is fastened on the lid of the case.

The receiver and power unit represent together a very stable chassis. Finally, the parts on the front panel have to be connected; the voltmeter V, the switch A-E, and the resistance R7, likewise the terminal screws on the receiver side. The final result is shown in Fig. 7.—*Funk Bastler.*

RADIO TELEVISION

The good jobs in any profession are held by the better-than-average men—the men with technical engineering training.

The leaders in radio today are the men who were STUDYING radio ten years ago. The leaders in Radio and Television tomorrow will be the men who are seriously preparing today.

We offer Advanced Courses in Practical Radio and Television Engineering for the experienced radioman—Complete Courses in Practical Radio and Television Engineering for the less experienced radioman.

Send in the coupon for complete details TODAY.

Capitol Radio Engineering Institute
Riggs Bank Bldg., 14th & Park Road, N.W.
Washington, D. C.

Please send me without obligation complete details of the following course: (Check course).

- Advanced course in Practical Radio Engineering
- Complete course in Practical Radio Engineering
- Advanced course in Practical Television Engineering
- Complete course in Practical Television Engineering

Name

Address

.....(Jan. 3, 11, C.)

See JERRY GROSS if You Want Transmitting Equipment, Parts or Short Wave Material

Special transmitters, etc., built to order at reasonable prices.

Eisemann Headphones 2200 ohms... real sensitive. Special per pair \$1.50.

8-8 mfd. 450 V Aerovox Electrolytic Condensers, \$1.35 each. (Limit, four to a customer.)

AND HERE'S GOOD NEWS

Jerry's Free Code class on the premises from 6 to 7 P. M. Wednesday nights. This is a good chance to learn the code. Bring your own headphones.

Copper tubing all wound ends drilled free 1/4" x 2 3/4" diameter, 10c per turn.

Aluminum Panels { 1/16" — 7/10c per square inch
3/32" — 3/4c per square inch
1/8" — 1c per square inch

Write for our prices on aluminum cans. ALL NATIONAL RECEIVERS IN STOCK. GET OUR PRICES BEFORE BUYING. Don't be fooled by other sets. The National set has a tuned screen Grid Stage.



23 Warren Street New York City

ATTENTION Dealers and Servicemen

Write now for our new 1932 Radio catalogue. Everything listed at lowest possible wholesale prices.

JOHNSON RADIO MFG. CO.
Tarrytown Rd. Pleasantville, N. Y.

AUTOMATIC VOLUME CONTROL

Is obtainable in the HY-7 Short-Wave Superheterodyne. With or without A. V. C., as you wish. Write now.

National, Aerovox, Flechthelm, Pilot, Electrad, International, Centralab, Polymet, Sprague, Cardwell, Insuline, Frost, Tobe, Siemens-Halske, Clarostat, etc. 24 HOUR MAIL-ORDER SERVICE.

Write now, inclose 4c, for volume-control booklet. Helps on all repair and replacement problems. Simplifies every volume-control job.

NEW ACSW-5 by National

Uses '45 and '35 Tubes—in Stock

Kit price\$46.74
 Factory wiring 5.88
 Power-pack 23.24
 Standard SW-5, '35 and '27 tubes.
 Kit price\$46.74
 Factory wiring 5.88
 Power-pack 20.57
 SW-3—Wired 32.34
 D.C. 2 volt models at comparable prices.
 Act now, offer good for 30 days.
 Full stock National Parts.

Hatry & Young

119 Ann St.



Phone 5-2755

HARTFORD, CONN., U. S. A.



Stoppani Belgian Compass

Being a precision instrument, the Stoppani Compass lends itself admirably for use in the Radio Experimenter's test laboratory. It affords an ideal means of determining the polarity of magnets, electro-magnets and solenoids carrying current. Since the compass needle is itself a magnet, having a North-seeking pole (which is actually the South pole) and South-seeking pole (which is actually the North pole); and since, as we all know, like poles attract each other and unlike poles repel each other, it is merely necessary to bring the compass in the vicinity of the magnet under test. The North pole of the compass needle will then point to the North pole of the magnet under test or the South pole of the needle will point to the South pole of the magnet depending, of course, upon their relative positions.

May Be Used As a Galvanometer

Because of its uniform magnetic properties, high sensitivity, and delicate frictionless bearings, the Stoppani compass may be utilized to advantage as a highly precise galvanometer for detecting electric currents in experimental or conventional radio circuits. The Compass is easily and readily converted into said galvanometer by merely winding several turns of ordinary radio wire completely around the face and lower case of the compass; leaving small spaces between turns to observe the movements of the needle. The ends of the wire are brought out as test leads to be inserted in series in circuits under test. A deflection of the compass needle in either direction indicates the presence of an electric current. Incidentally the intensity of the current may be closely approximated since the force with which the needle gyrates is proportional to the intensity of the current flowing through the wire. Stoppani Compass is an ideal SURVEYORS' instrument with elevated sights. It is made of Solid Bronze, Parkersized, non-rusting, graduated in 1/10. Ruby Jewelled, 4 inches square. Fitted in a hardwood case, with set screw in corner to hold needle rigid when not in use. The United States Government paid more than \$30.00 for this precision instrument.

Our Price \$4.50

Gold Shield Products Company
 102 Chambers Street New York, N. Y.

"HAM" ADS

Advertisements in this section are inserted at the cost of two cents per word for each insertion—name, initial and address each count as one word. Cash should accompany all "Ham" advertisements. No less than ten words are accepted. Advertising for the February-March issue should be received not later than December 10th.

UV203-A, socket \$10. Radiola 28, \$10. Radiola III, \$2.50. Silver Marshall "B" Eliminator, \$5.00. German Seibt headphones, \$2.00. RCA 210 Uni-Reetron with tubes, \$9.00. Silver Marshall 210 Unipac, \$25.00. E. Carter (W2CG1), 922 Crane St., Schenectady, N. Y.

WANTED—SW Receiver. Transmitter. Write Armstrong, Holderness School, Plymouth, N. H.

SWAP stamp collection, photoelectric cell, radio magazines, parts and books for other parts, radio magazines, camera or ? Esperanto correspondence wanted. Lindberg (W8CIL), Sherman, New York.

DON'T grope in the dark for short wave stations. Read the International Short Wave Club magazine and learn what others are hearing. News is mailed to you within five days after it is received at headquarters, in time to be of value in tuning-in. Ask the fan who is a member. Send for particulars. International Short Wave Club, Klondyke, Ohio. The Oldest short wave broadcast listeners' organization in the world.

HAVE Adding Machine; Addressing Machine; Multigraph; Philco B Eliminator. Want rotary converter, (32 v. DC—110 v. AC); Semi-Automatic key; Power transformers; Short-wave super; Transmitter parts; meters, etc. Send list and full descriptions. Hubert Sherman, Cloverdale, Ind.

SPECIAL—Power packs for 4 UX 210s 550 Volts pure DC at 160 mills, 7½ volts AC for filaments at 5 amperes CT. at \$15.00. Filter chokes 160 mills 42 henry \$2.00. 500 mills \$5.00; also filter condensers any rating. 40% off. Wireless Supply Company, Charlotte, Mich.

TWO tube, combined transmitters and receivers put up for \$6.50. John Kumpas (WICPU), 54 Cobasset Street, Worcester, Mass.

The Propagation of Short Waves

By ROBERT MEYER

(Continued from page 274)

is shown in its summer and winter positions. Although both illustrations show the same time position of 18 o'clock (i.e., 6 P. M.) Greenwich time, the continents differ greatly in their positions to the network of conductive lines. For instance, the course of radio waves from Europe to South America is considerably longer in winter than in summer, and the operating conditions are worse.—*Wissen und Fortschritt.*

How to Cure "Dead Spots"

(Continued from page 273)

and the writer has designed one in which no serious dead spots occur over the whole of the short-wave tuning range. This consists of a ½-inch ebonite or bakelite tube, 4 inches long, on which is wound one layer of No. 36 wire.

Dead spots will also sometimes occur when a tickler coil of too many turns is used. Always use a tickler coil as small as possible, consistent with steady regeneration effects.—(EDITOR'S NOTE: Wire sizes are British Wire Gauge.)

Enhanced Audio Amplification

(Continued from page 276)

But this is not all; accentuation, or the reverse of the low-note reproduction can (within limits) be varied by changing the value of condenser "C." If its capacity is 0.5-mf., a rising characteristic of 1.4 times that with a 1-mf. condenser can be obtained at 40 cycles; whereas, if its capacity is 2 mf., a falling characteristic of 0.875 times that of the 1-mf. capacity is obtained.

Therefore, if your speaker is deficient in its bass response, the value of "C" should be altered to 0.3 or 0.5 mf.—E. T., Somerset, G2DT (England).

Simple Sending Antennas for Amateurs

(Continued from page 259)

wire is to be a multiple of half the wavelength. A length of 40 meters is especially favorable; since with it 20-, 40-, and 80-meter waves can be sent.

The tuning is done in this way; first, the absorption circuit is brought in resonance with the sender, as determined by the hot-wire ammeter. The antenna is connected at the side opposite the meter which, with correct adjustment, should not be affected by this. In practice, however, current changes of 15 to 20% play no important part; and operation is possible even with fluctuations of over 30%.—From "Radiowelt."



45 VESEY STREET
NEW YORK

New York's Headquarters for
Transmitting Apparatus

IT'S A WOW

A Real 5-Meter Xmitter.

LEEDS leads again with the latest
56 MC transmitter kit

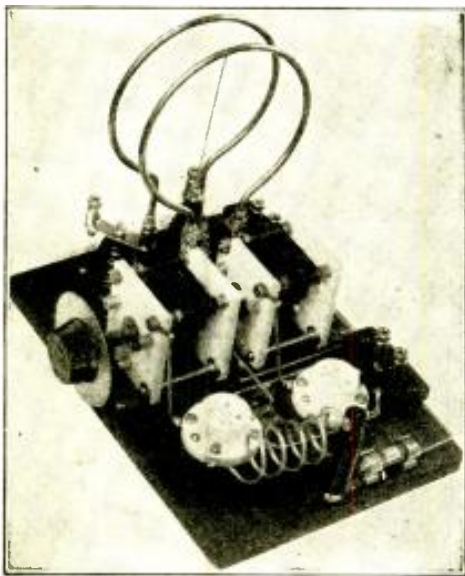

COMPLETE KIT, \$18.50

This 5 meter transmitter, fully described in Oct. 1931 General Radio Experimenter.

Write for FREE folder giving complete data and hook-up

We recommend Hulls 5 meter super regenerator receiver described in July Q.S.T. 1931.

Composed of the following parts.

1 Aluminum Panel 5"x7"x1/8"	\$.25
1 Aluminum Panel for base 5"x8"x1/8"	.28
2 Aluminum Brackets 2 1/2"x6 1/2"	.30
1 National Type "A" Dial	1.47
1 Special Insulated Coupling	.25
1 Cardwell 406-B	1.65
1 Bakelite 1/4" Rod	.15
1 Cardwell Balancer Condenser	.75
1 .00025 Fixed Condenser	.15
1 .004 Fixed Condenser	.30
2 1 mfd Flechtheim or Aerovox @ 60c.	1.20
1 .1 907 Condenser	.25
1 .001 Condenser	.21
1 Lynch 2 meg Resistor	.30
1 50,000 W.W. (larostat)	.90
2 2,000 ohm Electrical Suppressors @ 24c.	.48
1 150,000 ohm Lynch Resistor	.30
4 General Radio 274-J Jacks @ 5c.	.20
1 Pair Plug-in Coils as specified	.70
1 R. F. Choke as specified	.35
3 General Radio 438 Sockets	1.05
1 Phone Jack	.30
5 Eby Binding Posts @ 9c.	.45
1 General Radio 285-H Transformer	1.30
1 Oscillator Coil as specified, wound on bakelite form	1.50
1 pair bakelite end plate for condenser mount as specified	.50
Hardware	.85
	\$16.39

COMPLETE KIT
specially priced. Any parts sold
separately as listed. **\$14.75**

Note above prices approximately 30% discount have been deducted from the regular list price.

When to Listen In
By "BOB" HERTZBERG

(Continued from page 263)

Holland

One of the less-frequently heard Dutch stations is PCV, located at Kootwijk, Holland. This uses a wave of 16.85 meters, and, like its brother station PCJ, announces in several languages. It is on the air Saturdays at about 10:30 in the morning, EST.

California

The west coast station that has been working with Bangkok, Siam, is KER, Bolinas, California, on approximately 29 meters. There is a whole flock of KE-stations at this place likely to be heard on a number of wavelengths at all hours of the day and night.

Australia

Following is the complete schedule of station VK2ME, Sydney, Australia: Midnight to 2 a. m., E.S.T., for American countries bordering the Pacific. 4:30 to 6:30 a. m. for New Zealand, Fiji, New Caledonia, New Guinea, and Islands of the Pacific and Eastern Australia. 6:30 to 8:30 a. m. for West Australia, Java, Japan, China, Straits Settlement, Burma, Ceylon and India. 2:00 to 4 p. m. for Great Britain, Western Europe, South Africa, British East African possessions, Egypt and other African countries. All programs include as a sort of identifying signal the laugh of the Kookaburra, an Australian bird sometimes called the "laughing jackass".

Melbourne, Australia, VK3ME, transmits on the same wavelength from 5:00 to 6:30 a. m. every Wednesday and Saturday.

More Time Signals

Mr. Ernest Madison, of Scranton, Iowa, sends in some dope on station NPO, the U. S. Naval Radio Station at Cavite, P. I. He has received a letter from them, part of which follows:

"NPO broadcasts time signals for the Manila Observatory twice a day at 11:00 a. m. and 10:00 p. m., 120th East Meridian Time. NPO uses the following frequencies, one of which you can hear an hour of the day: 17744, 13575, 13308, 9650, 8892 and 18100 kilocycles. Transpacific traffic is handled on 13575 and 9650 kc. with a 25-kw. crystal-controlled transmitter.

Arlington Time Signals

The Naval radio station at Arlington, Virginia, is undoubtedly the best known of all stations transmitting time signals. We have been able to obtain the operating schedule, which is published herewith in full.

NAA Daily Time Signals

Hours, E.S.T.	Kilocycles	Meters	Power
3:00 a. m.	17.8 (arc) A1	16850	350 K.W.
	113 A2	2840	5 K.W.
	4015 A1	74.72	10 K.W.
11:55-12:00 Noon	8030 A1	33.98	10 K.W.
	113 A2	2840	5 K.W.
	690 A3	434.5	1 K.W.
Noon	4015 A1	74.72	10 K.W.
	8870 A1	33.82	10 K.W.
	12045 A1	24.91	10 K.W.
	16060 A1	18.68	10 K.W.
	17.8 (arc) A1	16850	350 K.W.

A New Console Receiver
for S. and B.C. Waves

(Continued from page 263)

A big advantage of the Stewart-Warner converter is that in changing from the broadcast band to short waves—and vice versa—it is not necessary to disconnect the converter and attach the antenna to the broadcast receiver. This, as well as the change from one short-wave range to another, is accomplished by the "range switch".

A NEW
CIRCUIT

The Engineering Department of the Shallcross Mfg. Company has designed a general-purpose

COMBINATION
MULTI-RANGE

Voltmeter and Milliammeter,
A.C. and D.C.

employing the new Weston A.C. and D.C. Type 301 Universal Meter and

SHALLCROSS
Super Akra-Ohm



RESISTORS

The voltage range is from 5 to 1000 volts, 1000 ohms per volt and the current range is from 1 to 500 Milliampères A.C. and D.C. A complete diagram and full information on the construction of this circuit are contained in our Bulletin 150-X, which also contains very useful information on the application of Akra-Ohm Resistors to multi-range voltmeters, ohm meters, etc.

Our new Bulletin 150-X will be sent upon receipt of 4 cents in stamps.



THE ONLY WAY

To be sure you won't miss an important article is to subscribe to
SHORT WAVE CRAFT

PANELS
TUBING & RODS

FORMICA, BAKELITE AND HARD RUBBER—STANDARD OR SPECIAL SIZES

Cut While You Wait

Drilling, Engraving and Special Work



All Sizes of

ALUMINUM

CANS, PANELS

AND CHASSES

Made and Cut to

Order

Neutralizing
Screw Drivers,
Short or
Long Sizes



COUPLINGS in
Brass and Bake-
lite for 1/4 inch
Shafts

INSULATING BUSH-
INGS for all size Shafts

TEL. CORTLANDT 7-4885
Mail Orders Filled Immediately

United Radio Mfg. Co.
191 Greenwich St. New York

— no greater magazine published on TELEVISION —

Now 25c A Copy

4-Color Cover 9 x 12 in.



On All Newsstands

A Brief Summary of Contents

Prominent Television Authorities

AYLESWORTH—REPLOGLE—DR. NOACK—VON ARDENNE—NASON—ZEH BOUCK—DR. BUSSE BOOGARD

FEATURES:

- Editorial. The Promise of Television, by Merlin H. Aylesworth, President, National Broadcasting Co. Von Mihaly Television System Used at German Station. Television Images Caught at Sea. In the Television Eye. Strike One! Greets Japanese Visualists, by H. Winfield Secor. What Will the Radiovisor of Tomorrow Be Like? by D. E. Replogle. Television at the German Radio Exposition, by Dr. Fritz Noack (Berlin). Yes—Europe Sees Images With Cathode Ray Tubes, by Baron Manfred Von Ardenne. The Crater Tube, by D. E. Replogle. Building a 1,200-Cycle Synchronous Motor, by Kenneth E. Sherman. Getting Started in Television, by Edwin J. Bachman. How I Built My Home Radiovisor, by Edmund Deane, Jr. A Short Course in Television, Lesson 5, C. H. W. Nason, Television Engineer. Stenode Applied to Television, by Zeh Bouck. Jenkins New Home Projector Produces Brilliant Images. Hints on Using a Braun Tube As a Scanner, by Dr. Ernst Busse. Can the Amateur Help Perfect Television? Yes—Says A. G. Heller, Chief Engineer, Insulline Corporation of America. A Super-Crater Neon Tube, by C. H. W. Nason. Possible Solutions of the Television Problem, by P. F. v. d. Boogaard, University of Lieke. An Electronic Light Valve, by Wolf S. Pajes. TELEVISION RECEIVERS: Combination Television and Broadcast Receiver.

- New 3 By 3 Ft. Image Projector. Cathode Ray Receiver. How the Crater Tube Works. This Outfit Receives Radio Movies 1,000 Miles, by Raymond Stepiens. Building a 1,200-Cycle Synchronous Motor. Getting Started in Television. How I Built My Home Radiovisor. The Theory of Lens Disc Projectors. The Stenode Television Receiver. New Jenkins Home Projector. A Braun Tube As a Scanner. How to Build An Automatic Synchronizing Brake. What Shape Scanning Hole? New Television Kits Help Popularize the Art. A Super-Crater Neon Tube. New Photo-Tells and Neon Tubes. Hints on Synchronizing. TRANSMITTERS: Cathode Ray Transmitters. The Necessary Difference in Transmission Frequency for Television. MISCELLANEOUS: Chicago Steps Ahead in Television. Behind the Scenes in a Television Studio. A 60-Cycle Plonic Wheel. Tin-Foil On Neon Tube Brightens Image. Synchronizing the Television. The "Multi-Screen" Makes Images Visible From All Angles. Novel Television Ideas From Vienna. Keeping in Step, by Henry Townsend. Seeing Is Believing (\$5.00 Prize for Best Image Photo). Digest of Television Patents. The Television Question Box. Television Time-Table.

Timely developments in radio's latest wonder, Television, are published in every issue of TELEVISION NEWS—Mr. Hugo Gernsback's latest magazine. Rapid advancement in this art today is becoming a repetition of the radio cycle of years ago. Daily broadcasts are becoming more numerous and experimenters are following in quick order in building television sets for experimental purposes. Foresight of its development can be seen by the pioneers of radio—they are equipping themselves now with television experience.

The articles published in TELEVISION NEWS are of primary importance to experimenters—they are simple in construction, understandable and replete with diagrams, photographs and illustrations.

S-W Stations of the World

(Continued from page 279)

- 124.2 2,416—WPDI, Columbus, O. — WPDE, Louisville, Kentucky. —KGPB, Minneapolis, Minn. — WPDJ, Passaic, N. J. —WPDS, St. Paul, Minn. — WPGA, Tulare, Calif.
124.5 2,410 —WCK, WRDR, WMD, Detroit (Belle Isle, Grosse Pointe, Highland Park, Mich. —WPDW, Washington, D. C. —KGPB, San Francisco, Calif. —KGGP, Vallejo, Calif. Police Dept. —W3XAG, Baltimore, Md., Police Dept.
125.1 2,398 —W9XL, Chicago, Ill. —W2XCU, Ampere, N. J. —And other experimental stations. —W2XAD, W2XAF, Schenectady, — WPDJ, Kokomo, Ind. Police Dept.
125.4 2,392 —WIOXAL and WIOXAO, Portable, National Broadcasting Co. —W2XCZ, Portable, N.B.C.
128.0-129.0 —Aircraft.
129.0 2,325 —WIOXZ, Airplane Television.
130.0 2,306 —ODDX, S.S. "Bremen" and "Europa" testing.
135.0 2,220 —Stockholm, Sweden. —Oslo, Norway.
136.4 to 142.9 meters—2,100 to 2,200 kc. Television. —W2XBS, New York, N. Y., 1,200 R.P.M., 60 lines deep, 72 wide, 2-5 p.m., 7-10 p.m. ex. Sundays. National Broadcasting Co. —W2XR, Long Island City, N. Y. 48 and 60 line, 5-7 p.m. Radio Pictures, Inc. —W3XAD, Camden, N. J. —W2XGW, Schenectady, N. Y. —W3XAK, Bound Brook, N. J. (Portable, 60 lines). —W8XAP, Pittsburgh, Pa. 1,200 R.P.M., 60 holes, 1:30-2:30 p.m., Mon. Wed., Fri. —W9XAP, Chicago, Ill. —W6XS, Gardena, Calif. Don Lee, Inc. Los Angeles.
142.9 to 150 meters—2,000 to 2,100 kc. Television. —W2XAP, Jersey City, N. J. —W2XCR, Jersey City, N. J. 3-5, 6-9 p.m. ex. Sun. —W3XK, Wheaton, Maryland, 10:30 D.M.-midnight ex. Sun. Works with W3XJ. —W2XBU, No. Beacon, N. Y. (1-2 p.m.). —W2XCD, Passaic, N. J. 2-3 p.m. Tu., Thur., Sat. —W9XAD, Chicago, Ill. —W9XAA, Chicago, Ill. —WIOXG, portable, De Forest Radio Co. —VESAU, London, Ont., Canada. —VESRM, Toronto, Ont., Canada.
150 2,000 —RA72, Smolensk, USSR.
149.9-174.8—2,000-1,715—Amateur Telephony and Television.
160 1,875 —Cuxhaven, Germany. Elbe-Weser Radio.
174.0 1,723 —ZL2XS, Wellington, New Zealand.
175 1,715 —W9XAN, Elgin, Ill. —W6XK, Los Angeles, Calif. And other experimental stations.
175.2 1,712 —Municipal, Police and Fire. —K6KM, Beaumont, Texas. —WKDT, Detroit, Mich. —WEY, Boston, Mass. —WPDB, WPDC, WPDD, Chicago, Ill. —WKDU, Cincinnati, O. —KSW, Berkeley, Calif. —WKDU, Cincinnati, Ohio. —KUP, Dallas, Texas. —WMDZ, Indianapolis, Ind. —KGPC, St. Louis, Mo. —KGOY, San Antonio, Texas. —K6JX—Pasadena, Calif. (Police Dept.). —St. Quentin, France. —F8FY, Cannes, France. 5 p.m. Wed.; 4 a.m. Sunday.
176.5 1,700 —Orly, France.
178.1 1,684 —WKDX, New York, N. Y., Dept. Plant & Structures. —K0X, Honolulu, T. H. Mutual Telephone Company.
180.0 1,662 —WMP, Framingham, Mass. (State Police). —WRDS, Lansing, Mich. (State Police).
186.6 1,608 —W9XAL, Chicago, Ill. (WMAC) and Aircraft Television. —W2XY, Newark, N. J.
187.0 1,604 —W2XCU, Wired Radio, Ampere, N. J. —W2XCD, DeForest Radio Co., Passaic, N. J. 8-10 p.m., synchronized with television broadcasts. —WIXAU, Boston, Mass. —W3XJ, Wheaton, Md. —W2XAD—W2XAF, Schenectady. —W3XX, Carversville, Mo. —W3XN, Dallas, Texas. —W2XDD, Portable. —And other experimental stations. —Ornskoldsvik, Sweden.
187.9 1,596 —WCF, New York, N. Y. (Fire Dept.) —WKDT, Detroit, Mich. (Fire Dept.). —K6KM, Beaumont, Texas. —K6PA, Seattle, Wash., Fire & Police Depts.
189.4 1,584 —WIOXAL, WIOXAO, Portable (N. B. C.)
192.3 1,560 —Scheveningen, Holland.
194.3 1,544 —W2XDA, New York.
196 1,530 —Karlskrona, Sweden.

COMPLETE COURSE IN TELEVISION

Over 200 Illustrations, Diagrams, Circuits and Photographs — Actual Photographs of Television Transmitters and Receivers.

Rush Coupon TODAY!

Special Offer

VOID AFTER DECEMBER 31st

The regular price of TELEVISION NEWS is \$1.50 a year (Canada and foreign, \$1.75). Up to December 31st, if you use the coupon at the left, we will accept \$1.25 (Canada and foreign, \$1.50) for a full year's subscription. THIS OFFER WILL NOT BE MADE AGAIN.

Published Every Other Month

TELEVISION NEWS SWC-2-4

88 Park Place, New York, N. Y.

As per your special offer, I enclose herewith \$1.25 (Canadian and foreign \$1.50) for which enter my subscription to TELEVISION NEWS for One Year.

Name

Address

City..... State.....

PATENT Z.H. POLACHEK DO IT TRADE-MARK BY 31st NEW YORK NOW REG. PATENT ATTORNEY PROF. ENGINEER WHAT IS YOUR INVENTION? Send me a simple sketch or model for CONFIDENTIAL ADVICE

DATAPRINTS!!

ARRIVED AT LAST!

Blueprint Construction Data for Building Apparatus that many amateurs have longed to own, but lacked the Construction Data.

How to build 1/16 H.P. 110 volt A.C. 60 cycle motor (Suitable for Television).....	\$1.00
How to build 60 cycle Phone Wheel.....	.50
Data for a 1,200 cycle Phone Wheel.....	.50
Construction data for powerful battery electro-magnet.....	.50
Data for 110 volt, D.C. magnet to lift 25 pounds.....	.50
Data for 110 volt, D.C. Solenoid to lift 2 pounds through 1 inch.....	.75
Data for 110 volt, D.C. Solenoid to lift 6 pounds through 1 inch.....	.75
Data for 12 volt, D.C. Solenoid to lift 2 pounds through 1 inch.....	.50
Tesla or Oudin coil data for 30 "30" spark.....	.75
Tesla or Oudin coil data for 6 to 8" spark.....	.75
Transformer data: 100 to 5,000 watt. (1 primary and 1 secondary) (specify size and voltage desired).....	1.00
Home Refrigerating Machine.....	1.00
Telegraphone (records voice on steel wire).....	.75
10 Short wave operating kinks.....	.75
10 Television operating kinks.....	1.00
(Including lens disc and center tubes).....	.75
Electric chime rings for ordinary clocks.....	.75
Electric Ice Skates—how to make.....	1.00
How to Thaw Pipes Electrically.....	1.00
20 Motor Circuits.....	1.00
20 Telephone Hook-ups.....	1.00
20 Tests for Motor Troubles.....	1.00

Send Check or Money Order (cash at own risk) no stamps. Prices quoted are postpaid.

The DATAPRINT Company
RAMSEY, N. J.
Lock Box 322

Get Started in RADIO

Write for free booklet telling about this growing and most promising industry. The radio operator is an officer aboard ship. His work is light, pleasant and interesting. He has many opportunities to travel to all parts of the world. You can qualify in a short time in our well-equipped school under expert instructors.

Announcing a New Course in TELEVISION

Starting January 4, 1932

Information on Request.

West Side YMCA Radio Institute

7 West 63rd Street New York
Established 1910

FOR REAL SATISFACTION



SIEMENS & HALSKE
CONDENSERS
RESISTORS
MICROPHONES
MORRILL
CONDENSERS

Write for Circular S3

MORRILL & MORRILL

Sole U. S. A. Distributors

30 Church St. New York City

Send for FREE



THE AIREX CO., Inc.
67 Cortlandt St., New York City

The Workrite Converter

(Continued from page 257)

—2-'24 screen grid, 1-'27, and 1-'80 tubes. The wavelength range covered is 14 to 200 meters; the popular band from 23 to 50 meters is tuned without changing the coils.

STATEMENT OF THE OWNERSHIP, MANAGEMENT, CIRCULATION, ETC., REQUIRED BY THE ACT OF CONGRESS OF AUGUST 24, 1912.

OF SHORT WAVE CRAFT, published BILMONTHLY at Mt. Morris, Ill., for Oct.-Nov., 1931.

State of New York; County of New York, ss. Before me, a Notary Public in and for the State and County aforesaid, personally appeared Hugo Gernsback, who, having been duly sworn according to law, deposes and says that he is the Editor of the SHORT WAVE CRAFT and that the following is, to the best of his knowledge and belief, a true statement of the ownership, management, etc., of the aforesaid publication for the date shown in the above caption, required by the Act of August 24, 1912, embodied in section 411, Postal Laws and Regulations, to wit:

1. That the names and addresses of the publisher, editor, managing editor, and business managers are: Publisher, Popular Book Corp., 98 Park Place, N. Y. C.; Editor, Hugo Gernsback, 98 Park Place, N. Y. C.; Managing Editor, H. Winfield Secor, 98 Park Place, N. Y. C.; Business Managers, none.

2. That the owner is: (If owned by a corporation, its name and address must be stated and also immediately thereunder the names and addresses of stockholders owning or holding one per cent or more of total amount of stock. If not owned by a corporation, the names and addresses of the individual owners must be given. If owned by a firm, company, or other unincorporated concern, its name and address, as well as those of each individual member, must be given.) Popular Book Corp., 98 Park Place, N. Y. C.; H. Gernsback, 98 Park Place, N. Y. C.; H. Winfield Secor, 98 Park Place, N. Y. C.

3. That the known bondholders, mortgagees, and other security holders owning or holding 1 per cent or more of total amount of bonds, mortgages, or other securities are: (If there are none, so state.) None.

4. That the two paragraphs next above, giving the names of the owners, stockholders, and security holders, if any, contain not only the list of stockholders and security holders as they appear upon the books of the company but also, in cases where the stockholder or security holder appears upon the books of the company as trustee or in any other fiduciary relation, the name of the person or corporation for whom such trustee is acting, is given; also that the said two paragraphs contain statements embracing affirming the full knowledge and belief as to the circumstances and conditions under which stockholders and security holders who do not appear upon the books of the company as trustee, hold stock and securities in a capacity other than that of a bona fide owner; and this affiant has no reason to believe that any other person, association, or corporation has any interest direct or indirect in the said stock, bonds, or other securities than as so stated by him.

5. That the average number of copies of each issue of this publication sold or distributed, through the mails or otherwise, to paid subscribers during the six months preceding the date shown above is — (This information is required from daily publications only.)

H. GERNSBACK.

Sworn to and subscribed before me this 29th day of September, 1931.

MANNIE COYNE.

(My commission expires March 30, 1932.)

New York Chapter of International Short Wave Club

This club, which has been meeting regularly at Peter's Banquet Hall, 217 Fulton Street, Brooklyn, New York, has had a steady growth in membership, which is now over the 300 mark, and the club has commenced to hold meetings in New York City. The office of the secretary of the club is located at 1622-44th Street, Brooklyn, N. Y. The club has held many successful meetings and is promising some extremely interesting attractions for the coming meetings.

450 Miles on a Gallon of Gas!

According to a recent article by the president of the world's largest motor research corporation, there is enough energy in a gallon of gasoline if converted 100% in mechanical energy to run a four cylinder car 450 miles.



NEW GAS SAVING INVENTION ASTONISHES CAR OWNERS

A marvelous device, already installed on thousands of cars, has accomplished wonders in utilizing a portion of this waste energy and is producing mileage tests that seem unbelievable. Not only does it save gasoline, and reduce carbon formation, but it also creates more power, quicker starting, snappy tick up, and a smoother running motor.

To Make Up To \$100 a Week and More

To obtain national distribution unlikely men are being appointed everywhere to help supply the tremendous demand. Free samples furnished to workers. Write today for this free sample and big money making offer.

WHIRLWIND MFG. CO.
Dept. 764-A, Station C Milwaukee, Wis.

WIRELESS or WIRE TELEGRAPHY

Everything Needed to Acquire Either or Both Codes

Code Transmitter
10 Rolls of Tape (2,000 ft. mtr.)
Complete Book of Instruction.
(Both Codes)

Extra Tapes

Write for Details

INSTRUCTOGRAPH CO., Dept. S.W.4
912 Lakeside Place Chicago, Ill.



The Masterpiece

In Microphone Construction — The New Heavy Duty Model "B B"

Model "B B"
List Price
\$25.00

A two-button microphone that has become the talk of the radio industry. It is 3 in. in diameter by 2 in. thick and is nearly twice as heavy as any other microphone in its class. Equipped with Extra Heavy 21 Kl. Gold Spot Centers, Duralumin diaphragms, Hair Fine precision of manufacture. Fully guaranteed. Finished in highly polished chrome plate. Compare this new, heavy duty Model "BB", listing at \$25.00, with any \$10.00 to \$50.00 microphone on the market.

UNIVERSAL MICROPHONE CO., Ltd.
1163 Hyde Park Blvd., Inglewood, Calif., U.S.A.

Radio Bargains

De Jur-Ansee, .0011 Vari-Cond.....	\$1.45
Federal 1 mfd. 1,000 Volt, metal can insulated.....	1.35
Federal 2 mfd. 1,000 Volt, metal can insulated.....	1.75
Told 30 hen. 100 mill. metal case.....	1.25
Midget Transformer, High 375-0.375, 5V-2A, 2 1/2V-2A, 2 1/2V-10A.M.....	2.25
Aluminum Can, 10Lx5 1/2x1 1/2 W.....	1.85
8 mfd. Mershon Electrolytic 150 P.W.V.....	.85
8 mfd. Elkon Dry, 130 P.W.V.....	.80
Gen. W. Walker Super Converter, Model 4X for 110 volt, 50-60 cycle A.C. current. List \$30.50, nos 2 221 Sc. Gr., 1-227, 1-280 less tubes.....	21.25

We can supply any type filament or low voltage transformer built to your specification, also Condenser Blocks.

PEERLESS TRADING CO.
118 West Street New York City

Back Number SALE!

4 Copies for \$1.00

Single Copies at Thirty-five Cents Each

HERE is a great opportunity to make a complete set of the issues of **SHORT WAVE CRAFT**—at a most sensational saving. This *back number sale* enables our readers to make a comprehensive file of all the latest material in the Short Wave field. These few complete books, which are easily accessible, might be used as a permanent reference.

Each issue on the newsstand sells for fifty cents per copy. This sale may be the last at such a tremendously low price of **FOUR FOR ONE DOLLAR**. Of course single copies must be sold at thirty-five cents each. Fill in the coupon at the bottom and mail NOW! Your copies of **SHORT WAVE CRAFT** will be sent to you immediately.

SHORT WAVE CRAFT, SWC-2-4
96-98 Park Place, New York, N. Y.

As per your special offer, I enclose herewith One Dollar for which please send me the four issues of **SHORT WAVE CRAFT** indicated below:
Single Copies at Thirty-five Cents Each

- October-November
- December-January
- February-March
- April-May
- June-July
- August-September

Name

Address

City..... State.....

SWAPPERS

SWAPPERS are swappers of correspondence. During the past few years we have noted that Short-Wave enthusiasts love to get acquainted with each other by mail in order to swap experiences.

Rules: Use a postcard only. Never write a letter. Address postcard as follows:

SWAPPERS
c/o SHORT WAVE CRAFT
96-98 PARK PLACE
NEW YORK, N. Y.

On the blank side of the postal PRINT clearly your name, address, city and State. Don't write anything else on card. We will then understand that this is your request to publish your name and address and that you wish to enter into correspondence with other short-wave readers. There is no charge for this service.

—EDITOR.

- JACK BANNON
412 Seneca St., Oil City, Pennsylvania
- GEORGE J. BARMAN
232 W. Second St., Chillicothe, Ohio
- ARCHIE BENNETT
1st Bn. 8th F. A., Schofield Bks., T. H.
- KENNETH BLOCK
870 Riverside Drive, New York City
- ALEXANDER R. BUDNIK
474 So. 12th St., Newark, N. J.
- ARTHUR P. K. BYRNES
Kenya, Salisbury Rd., Holland-on-Sea, Clacton-on-Sea, Essex, England
- ALBERT J. CANNING
1242 Madison Ave., Paterson, N. J.
- E. C. CHAMBERLIN, JR. (W9HVD)
6815 Chappel Ave., Chicago, Illinois
- FORMU. CIPHER. Q7YX
Point Rock, New York State, U. S. A.
- AUSTIN E. DIXON
R. F. D. 5, Box 75, Jacksonville, Florida
- JOHN J. DWYER
"Ellmore", Young, N. S. W., Australia
- HARRY W. GAUNT
524 Broad St., Meriden, Conn.
- IRVING GOLL
165 Cleveland Ave., Trenton, N. J.
- FRANK GREGOR
1921 W. 14th Ave., Gary, Ind.
- ALDEN R. GRIMES
2923 W. 43rd St., Minneapolis, Minn.
- DON HOLIDAY, W9DOY
c/o Radio Station WDAY, Fargo, No. Dak.
- WILLIAM HOPWOOD
Pirimon, Pa.
- JOSEPH JACKSA (W6CSV)
742 Madison St., Albany, Calif.
- LANE P. JACKSON
Box 664, University, Alabama
- BRUCE LEWIS KELLEY
120 Lenox St., Rochester, New York
- EDWARD KLASTER
2958 E. 34th St., Cleveland, Ohio
- R. A. LATHROPE
554 Broadway, Niles, Michigan
- FRED S. LEACH
McLean, Illinois
- EVERETT LINDQUIST
Vasa, Minnesota
- EDWARD MARKETTE
Box 75, La Belle, Florida
- FRANK J. MAYERNIK, W2ASM
6708 53rd Rd., Maspeth, L. I., N. Y.
- JOHN McNESSOP, JR.
218 Berlin Ave., Southington, Conn.
- EDWARD McQUADE
9 Lincoln Ct., Marlboro, Mass.
- JOSEPH J. MEKSRAITIS
541 School St., Minersville, Pa.
- EDWARD MOORY
Care Radio W5BDR
Box 311, DeWitt, Arkansas
- RUSSELL OLESON
320 S. Grove St., Waupun, Wis.
- ALEX. POLITYKA, JR., W8FLA
431 W. Lloyd St., Shenandoah, Pa.
- EDWARD J. POLITYKA
408 W. Atlantic St., Shenandoah, Penna.
- VINCENT RYAN
16 Hamilton Ave., So. Norwalk, Conn.
- CHARLES E. SMITH
24 Upland St., Lyman, S. C.
- LEO SABOLESKI
406 No. 2nd St., Minersville, Pa.
- WILLIAM SPANGENBERG
872 Woodward Ave., Brooklyn, N. Y.
- MARK THOMPSON, JR., W8AFP
Box 1, Indianola, Pa.
- FRANK WENCEL
2615 Evaline St., Hamtramck, Michigan
- ARMY-AMATEUR NET CONTROL STATION,
Long Island, W20Q,
249 Jericho Tnpk., Mineola, N. Y.
(Newbold Wheelock)

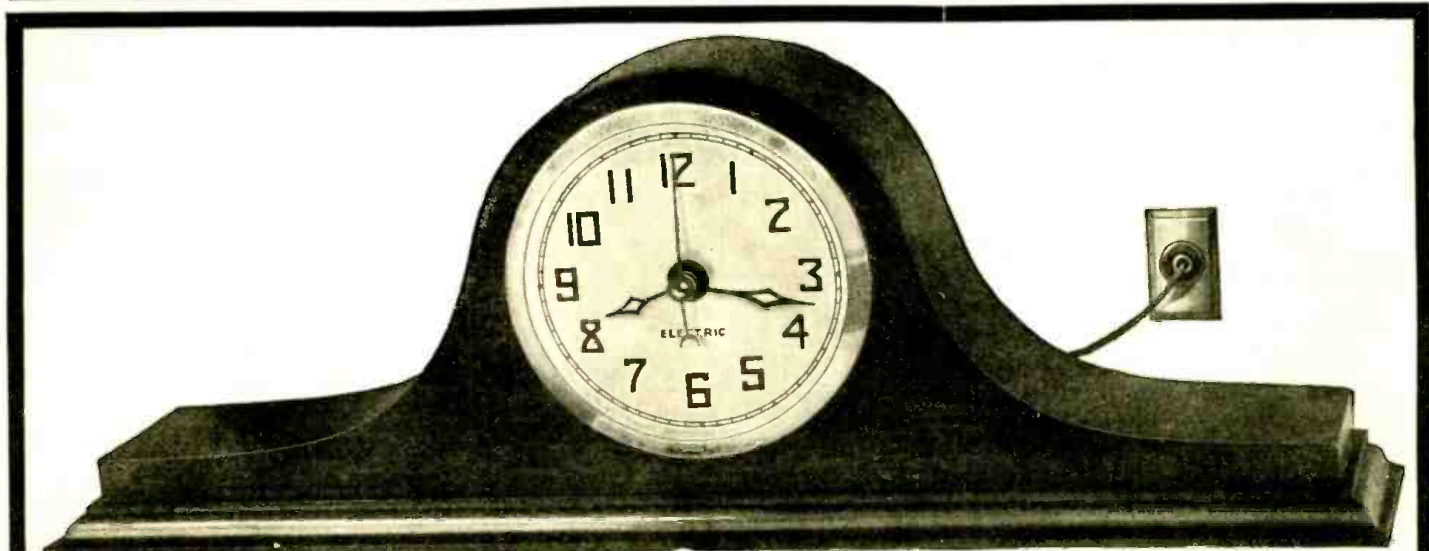

ELECTRIC MANTEL CLOCK

110 Volt A. C., 60 Cycle. 14 in. Base. An Ideal Holiday Gift.

YOUR PRICE

\$3.85

(List price \$6.75)
In lots of Three \$3.50 each
In lots of Six \$3.00 each

Here is the ideal small mantel clock for office desk, den, shop or store. It keeps perfect time by electricity, right from your house lighting current. 25 year guarantee. Finished in mahogany. 14 inches long at the base, and 5½ inches high. Sweep second indicator. Beautiful dial and rim. Convex lens. Made by one of the largest manufacturers of electric

clocks. Almost a million in use. We will ship one of these clocks to you, C.O.D., if you prefer. Or you can send cash with order. Sold on a money-back guarantee. Get one of these clocks for the family as a Christmas gift. Everybody can use an electric clock. Here is your opportunity to get one at a very low price. Only \$3.85

We Ship Same Day Your Order Reaches Us.

R. A. MATLI CO., 1114 Mission St., San Francisco, Calif.

STOP SHOPPING!!

HERE'S a NEW plan, which saves you money. Stop shopping—the lowest prices are right on this page. Yes, lower than in our own catalog. Why? Because no house can get out a new catalog every month, but by advertising in this magazine we can bring

you the latest and lowest prices up to the time this ad is printed. We watch our competitors and do not allow anyone to undersell us. We meet ANY price on NEW merchandise. Order direct from this page and save money. 100% satisfaction on every transaction.

Patent "250" Power Auditorium Amplifier



One of the Most Powerful Super Power Amplifiers ever made.

Now \$8.75

CONTAINS 2 STAGES SUPER POWER A.F. AMPLIFICATION

This famous amplifier is provided with input and output transformers for working from a phonograph pick-up into a 2000-ohm transmission line or into the coupling transformer furnished with most dynamic reproducers. This degree of power output provides satisfactory coverage for auditoriums having a volume of 25,000 cubic feet. The input voltage necessary to provide maximum output is but .025 volts.

Ideal for theatres seating approximately 3,000 people, dance halls, schools, lectures, hospitals, auditoriums, outdoor gatherings, etc., etc. The gigantic power is at all times within control—for that matter, it can be used in any home, as the volume can be regulated down to a whisper! A PHONOGRAPH AMPLIFIER—PUBLIC ADDRESS AMPLIFIER SYSTEM, ETC. 1.50 of the "26 tube in the input stage makes the long "warming up" period unnecessary. Shipping weight, 30 lbs. Overall size, 16 x 9 1/2 x 6 1/2" high. List Price, \$90.00.

No. 1925—Patent Model 250 Power Amplifier (less tubes). Your Price \$8.75

RADIO MIRROR PENLITE

The Latest and Cleverest Tool for Radio Servicemen. The only device that enables you to LOOK AROUND CORNERS or UNDERNEATH inaccessible spots. Your vision is ONLY in a straight line, but with the Mirror-Penlite you can look around a 45 degree angle. You can now look under the whole chassis and see every nut, every wire, every socket, levelling condensers, transformers, etc. This is made possible by the powerful pocket flashlight which is attached to a GENUINE DENTAL MAGNIFYING MIRROR. Mirror clips on or off so flashlight can be used alone if desired. The cleverest device yet. Complete with battery and bulb. Shipping weight, 8 ozs. No. 1695—Mirror-Penlite. List Price \$2.50. YOUR PRICE..... 85c

NEW! "LITTLE GIANT" DYNAMIC SPEAKER

Absolutely the smallest, yet dynamic speaker that will withstand the strain of modern output power tubes, ever manufactured.

Suitable for use on midsize, portable and automobile receivers. Measures but 6 1/2" in length overall, having a 4 1/2" in diameter and weighing but 1 lb. This "Little Giant" has, under test, actually flooded a ten-room apartment with faithfully reproduced music of virtually original tone quality. Field winding has a resistance of 2500 ohms and may therefore be energized by using it as a filter choke in the power pack, thereby serving a double purpose. This last feature makes the "Little Giant" excellently suited for portable A.C. sets, since it does away with filter chokes and thus with considerable weight. Equipped with built-in output transformer to work from any standard output power tube arrangement. Specify the power tube or tubes used when ordering. Shipping weight 5 lbs. List Price \$6.50. No. 1549. LITTLE GIANT DY. NAMIC SPEAKER. Your Price \$2.50

Baldwin RIVAL Speaker Unit

A loud speaker unit bearing the world famous Baldwin mark. Designed for use with horn type speakers or with old style phonographs. Complete with coil. Shipping weight 1 lb. POSITIVELY LOWEST PRICE THIS UNIT HAS EVER BEEN SOLD. No. 1520—Baldwin "Rival" Unit. YOUR PRICE..... 45c



NEW READRITE Analyzer

This three-meter analyzer has selector switch

for checking all parts of tube circuits by connecting to the set sockets. Selection for testing voltages of plate, grid, cathode and screen-grid done quickly and accurately. Plate current, filament volts, line and power supply volts are measured. Grid swing test for tubes used. Just push one button for screen-grid and other button for other tubes. Makes testing of all type tubes simple and thorough. 4 1/2-volt grid battery is furnished. Battery is used for grid test and continuity testing of transformers, chokes, etc. Capacity and resistance charts furnished showing use of instruments for testing condensers, also measuring resistances up to 100,000 ohms. Eight scale readings of meters may be used separately with the jack terminals provided. Scale readings are 0-60-300-600 D.C. volts, 0-10-140. Tube voltages are 0-60-300-600 D.C. volts, 0-10-140. Size 10 1/2 x 3 1/2 x 3 inches. Shipping weight 15 lbs. List Price \$25.00. No. 700—READRITE ANALYZER. YOUR PRICE..... \$14.70

700 A.C. volts and 0-20-120 milliamperes, A.C. and D.C. filament voltages are accurately measured on the one meter. Strong case with leatherette covering. Attractive. Compact. Size 10 1/2 x 3 1/2 x 3 inches. Shipping weight 15 lbs. List Price \$25.00. No. 700—READRITE ANALYZER. YOUR PRICE..... \$14.70

Free 36 page Radio Treatise No. 23



The new Summer Edition of our greatly enlarged RADIO SERVICE TREATISE has just come off the press. If you liked the Winter Issue, you will like this one a hundred-fold. It contains some 75 new hook-ups, circuit diagrams, and some 350 illustrations. POSITIVELY THE GREATEST BOOK EVER PUT OUT BY ANYONE. Among the new matters listed are:

VACUUM TUBE TREATISE, with many illustrations; full page Vacuum Tube Average Characteristic Chart; How to Take Care of Your Tubes; How to Connect Phonograph Pick-ups; Improving the Tone Quality of Old Sets; Connecting Additional Loud Speakers; All fully illustrated with diagrams.

Other articles: Modernizing Old Radio Sets; How to Control Battery to Power Sets; Selection of Tubes; Push-Pull Amplifiers; Rebuilding Audio Transformers; Piano Attachments; How to Choose Power Transformers; Voltage Dividers; Wattage of Power Transformers; Selecting and Installing Replacement Parts in Radio Sets; Filter Condensers; Repairing Eliminators.

WRITE TODAY. Enclose 2 cents for postage. Treatise sent by return mail.

75 New Hook-Ups, etc. 350 Illustrations.

NEW! NEW!! Superheterodyne S-W Converter

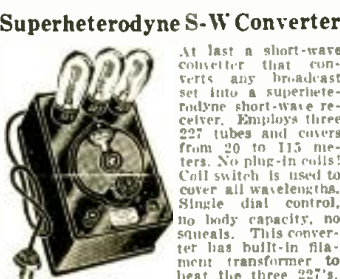

At last a short-wave converter that converts any broadcast set into a superheterodyne short-wave receiver. Employs three 227 tubes and covers from 20 to 115 meters. No plug-in coils! Coil switch is used to cover all wavelengths. Single dial control, no body capacity, no squeals. This converter has built-in filament transformer to heat the three 227's.

All you need to obtain from your receiver is a positive B voltage anywhere from 45 to 180 volts. Voltage is not critical; no modulation of the receiver. So simple a child can operate it. Size 7 x 10 x 5 inches. Shipping weight, 8 lbs. List Price \$25.00. No. 1614—Super Converter (less tubes). YOUR PRICE..... \$14.69

World-Wide Short-Wave Set NOT A CONVERTER

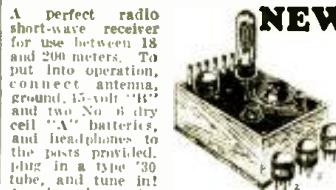

A perfect radio short-wave receiver for use between 18 and 200 meters. To put into operation, connect antenna, ground, 15-volt "B" and two No. 6 dry cell "A" batteries, and headphones to the posts provided. Plug in a type "30" tube, and tune in! An ingenious circuit makes possible a 3-coil single-winding plug-in design. This little instrument has the same sensitivity as many big, shielded short-wave receivers costing ten times as much. A power amplifier may be added for any degree of volume, complete with 1 plug-in coil. Has fine vernier dial for precision tuning. Never has a first class short-wave set sold for so little money. This short-wave set measures 5 1/2 x 7 1/2 in. high, over all. Shipping weight, 3 lbs. List price, \$12.50. No. 1666—World-Wide S.W. Set. YOUR price..... \$6.25

6 MONTHS GUARANTEED NEONTRON TUBES

Sold on a 6 MONTHS FREE REPLACEMENT GUARANTEE BASIS, PROVIDING TUBE LIGHTS! All tubes are carefully meter-tested before shipment, and carefully packed. Do not confuse these HIGH QUALITY tubes with any other "low priced" tubes—our low prices are possible because we do a VOLUME business!

NEW					
Choice	Choice	Choice	Choice	Choice	Choice
Price	Price	Price	Price	Price	Price
226	112A	215	222	230	237
227	200A-199X	280	210	232	217
171A	1991-V-120	171	250	232	238
201A	221		281		236-37
					551
63c ea.	69c ea.	79c ea.	1.58 ea.	1.08 ea.	1.50 ea.

R.C.A. LICENSED TRIAD AND PERRYMAN TUBES

These nationally advertised tubes are guaranteed UNCONDITIONALLY for six months. The prices are actually higher than our NEONTRONS because these tubes are of much better quality. See listing above for tube numbers.

Choice	Choice	Choice	Choice	Choice	Choice
Price	Price	Price	Price	Price	Price
76c	96c	86c	\$1.76	\$1.46	\$2.09

THORDARSON "245" Power Transformer

A Miniature Power Plant — Supplies All ABC Voltages — 80 Watts

In addition to supplying a full 250 volts to the filaments and 50 volts to the grids of two type "45" tubes in push-pull, this transformer may be used to light the filaments of seven or eight 2.5-volt filament tubes; and by connecting in series two of the three 2.5-volt filament secondaries it is possible to light 5-volt filaments too. Five secondaries: S1—5 V., 2 Amp.; S2—310 V. Cent. T.; S3—2 1/2 V., 3 Amp. Cent. T.; S4—2 1/2 V., 10 1/2 Amp.; S5—2 1/2 V., 3 Amp. Cent. T. Just the power transformer to build, using up a high-grade public address amplifier to use a screen-grid A.F. amplifier to boost the output of a microphone or phonograph pick-up; following this with two stages of push-pull amplification consisting of two "27's in the first stage and two "45's in the second. Bottom of transformer has bakelite panel on which are mounted all taps. It outperforms ANY similar transformer. Many Service Men keep this model transformer on hand for emergency replacements in hundreds of makes of radio sets. For 110-120 volts, 50-60 cycles. Size: 5 in. high x 4 x 3 1/2 in. Shipping weight, 8 lbs. List Price, \$15.00.

No. 1450—Thordarson Power Transformer. YOUR PRICE..... \$3.84

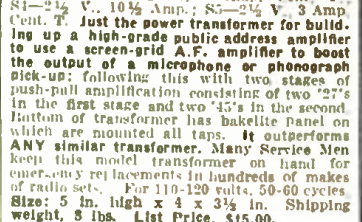

Flewelling-Dayton SW Adapter

This wonderful instrument connects to any A.C. radio set by putting into tube socket in place of the tube (which must be a type "27" or "heater" tube) the plug which is on the end of its 2 ft. cable; then put tube into tube-socket of adapter. Remove aerial from broadcast set and connect to antenna post on adapter. Special plug in coil No. 1 covers a wavelength band of 17 to 29 meters; coil No. 2, 27-28 meters; coil No. 3, 17-84 meters. Plug-in coils and adapters come with the adapter. 5 1/2 x 7 1/2 x 4 1/2" high, overall. Ship. weight 4 lbs.

No. 1613—Dayton Flewelling Short-Wave Adapter. List Price, \$15.00. YOUR PRICE (without tube).... \$4.93



Short-Wave Converter

Build a short wave converter at lowest price on record, but with which excellent results are obtainable nevertheless. The voltage for the three 227 tubes used may be obtained from an external filament transformer or from a secondary winding of 2 1/2 volts in a power pack. Wavelength from 30 to 110 meters. No plug-in coils; coil switch is used to cover wave band. Single dial tuning; no grunting, no body capacity, no squeals. Leak condenser modulation. Converter consisting of all parts (less filament transformer) including cabinet, panel, diagram and 1-page instruction sheet (less tubes). No. 1619—YOUR PRICE..... \$4.85

No. 1615—6-Volt Battery Model, same price.

High-Voltage Condenser Units

We guarantee these condensers unconditionally. They are ideal for general replacement purposes and can be installed in any new power pack. All condensers are furnished with 8-inch lengths of tinned "push-back" wire.

800 VOLTS			800 VOLTS		
Cat. No.	Mfd. Year	Price	Cat. No.	Mfd. Year	Price
1702	1/2	\$0.23	1708	1	\$0.40
1703	1/2	.30	1707	2	.70
1704	2	.30	1708	4	1.05
1705	4	.60			

WE ARE A WHOLESALE HOUSE AND CANNOT ACCEPT ORDERS FOR LESS THAN \$3.00.

If C. O. D. shipment is desired, please remit 20% remittance, which must accompany all orders.

If full cash accompanies order, deduct 2% discount. Send money order—certified check—U. S. stamps.

Radio Trading Co.
25A West Broadway
New York, N. Y.

ORDER FROM THIS PAGE. You will find special prices from time to time in this magazine. Get our big FREE catalog for the greatest Radio Bargains.

Should you wish goods shipped by parcel post, be sure to include sufficient extra remittance for same. Any excess will be refunded.

I will train you at home

to fill a **BIG PAY** Radio Job!



Here's Proof



\$100 a week

"My earnings in Radio are many times greater than I ever expected they would be when I enrolled. They seldom fall under \$100 a week. If your course cost four or five times more I would still consider it a good investment."

E. E. WINBORNE
1267 W. 48th St.,
Norfolk, Va.



Jumped from \$35 to \$100 a week

"Before I entered Radio I was making \$35 a week. Last week I earned \$110 servicing and selling Radios. I owe my success to N. R. I. You started me off on the right foot."

J. A. VAUGHN
3107 S. Grand Blvd.,
St. Louis, Mo.



\$500 extra in 6 months

"In looking over my records I find I made \$500 from January to May in my spare time. My best week brought me \$107. I have only one regret regarding your course—I should have taken it long ago."

HOYT MOORE
R. R. 3, Box 919,
Indianapolis, Ind.,

If you are earning a penny less than \$60 a week, send for my book of information on the opportunities in Radio. It is free. Clip the coupon NOW. Why be satisfied with \$25, \$30 or \$40 a week for longer than the short time it takes to get ready for Radio?

Radio's growth opening hundreds of \$50, \$75, \$100 a week jobs every year

In about ten years Radio has grown from a \$2,000,000 to a \$1,000,000,000 industry. Over 300,000 jobs have been created. Hundreds more are being opened every year by its continued growth. Many men and young men with the right training—the kind of training I give you—are stepping into Radio at two and three times their former salaries.

You have many jobs to choose from

Broadcasting stations use engineers, operators, station managers and pay \$1,200 to \$5,000 a year. Manufacturers continually need testers, inspectors, foremen, engineers, service men, buyers, for jobs paying up to \$7,500 a year. Shipping companies use hundreds of Radio operators, give them world-wide travel with board and lodging free and a salary of \$80 to \$150 a month. Dealers and jobbers employ service men, salesmen, buyers, managers, and pay \$30 to \$100 a week. There are many other opportunities too. My book tells you about them.

So many opportunities many N. R. I. men make \$200 to \$1,000 in spare time while learning

The day you enroll with me I'll show you how to do 28 jobs, common in most every neighborhood, for spare time money. Throughout your course I send you information on servicing popular makes of sets; I give you the plans and ideas that are making \$200 to \$1,000 for hundreds of N. R. I. students in their spare time while studying. My course is famous as the course that pays for itself.

Talking Movies, Television, Aircraft Radio included

Special training in Talking Movies, Television and home Television experiments, Radio's use in Aviation, Servicing and Merchandising Sets, Broadcasting, Commercial and Ship Stations are included. I am so sure that I can train you satisfactorily that I will agree in writing to refund every penny of your tuition if you are not satisfied with my Lessons and Instruction Service upon completing.

64-page book of information FREE

Get your copy today. It tells you where Radio's good jobs are, what they pay, tells you about my course, what others who have taken it are doing and making. Find out what Radio offers you, without the slightest obligation. **ACT NOW!**

J. E. SMITH, President
National Radio Institute Dept., 1NB3
Washington, D. C.

Our Own Home
Pioneer and World's Largest Home-Study Radio training organization devoted entirely to training men and young men for good jobs in the Radio industry. Our growth has paralleled Radio's growth. We occupy three hundred times as much floor space now as we did when organized in 1914.



Special Free Offer



In addition to my big free book "Rich Rewards in Radio," I'll send you my valuable manual "28 Tested Methods for Making Extra Money." Never before available except to students. Now, for a limited time, it is free to readers of this magazine. How to make a good baffie for cone speakers, how to reduce hum in externally fed dynamic speakers, how to operate 25 cycle apparatus on 60 cycle current, how to operate 110 v. A.C. receivers on D.C., how to shield sets from local interference are five of the subjects covered. There are 23 others. Get this valuable book by mailing the coupon now.

Act Quickly

I will give you my new 8 OUTFITS of RADIO PARTS for practical Home Experiments

You can build over 100 circuits with these outfits. You build and experiment with the circuits used in Crosley, Atwater-Kent, Excelsior, Majestic, Zenith, and other popular sets. You learn how these sets work, how to make them work. This makes learning at home easy, fascinating, practical.

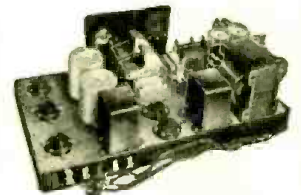

I am doubling and tripling the salaries of many in one year and less. Find out about this quick way to

BIGGER PAY



FILL OUT AND MAIL THIS COUPON TODAY



J. E. SMITH, President
National Radio Institute, Dept. 1NB3
Washington, D. C.

Dear Mr. Smith: I want to take advantage of your special free offer. Send me your two books, "Rich Rewards in Radio" and "28 Tested Methods for making extra money." I understand this request does not obligate me and that no salesman will call.

Name.....
Address.....
City..... State.....

Lifetime Employment Service to all Graduates

NOW You Can Do It!



**LIST
PRICE
\$25.00**

less microphone

Microphone as illustrated.
\$10 additional

AT LAST it has become possible for every Short Wave enthusiast to actually record his messages be they code or phone.

How often have you boasted that you have received a far distant phone station, 12,000 miles away, so loud that it "rattled the gaskets of your loud speaker." But frequently your friends were highly skeptical.

Now with the PACENT RECORDOVOX, recording of any foreign program becomes child's play. And, of course, the RECORDOVOX is supreme as well for home recording, because it faithfully records and keeps for posterity the voices of the entire family.

The special blank records cost only a few cents and can be secured anywhere.

Electrically and mechanically, the PACENT RECORDOVOX is as fine an instrument as you could find even in the professional recording laboratories.

Every possible angle has been taken into consideration in the design of the RECORDOVOX. Supplied with 3 adjustable weights, it can be used with motors that lack sufficient torque to operate the turntable when the head is fully weighted. Like the well-known PHONOVOX, the RECORDOVOX, as the result of careful design, possesses excellent frequency characteristics.

Designed for pre-grooved type of records only. List Price \$25.00. Microphone \$10.00 list extra.

*Write for information on special types and models
to meet your specifications*

Manufacturers

PACENT ELECTRIC CO., INC., 158 W. 16TH ST., NEW YORK, N. Y.
Pioneers in Radio and Electric Reproduction for Over 20 Years. Licensee for Canada: White Radio, Ltd., Hamilton, Ont.



Electric Phonograph Motor, Catalog No. 140

Meets every requirement of radio-phonograph use. Has sufficient torque to cut even 10" records.

List Price \$25.00

PACENT

RECAPTURE
the THRILL of
EARLY RADIO
RECEPTION

Hear the
Short-Wave Stations
of the World: direct
With the NEW PILOT

SUPER-WASP

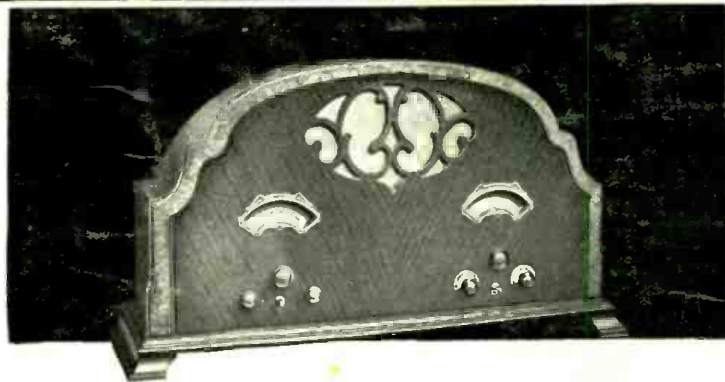

This 4-tube Short-Wave Converter transforms any modern radio receiver into a short-wave set instantly. Complete with newest type tubes, including rectifier.

\$39.50

Day or night, Pilot's marvelous SUPER-WASP brings in all kinds of new and startling things—airplane-to-ground conversations, transoceanic telephone calls, foreign broadcasting stations and, most exciting of all, police headquarters in a dozen cities talking to their radio-equipped "emergency cruisers." This 11-tube Super-heterodyne has separate controls for the broadcast band, with special high quality, high selectivity circuit. Including newest type tubes and built-in dynamic speaker. **\$99.50**



Pilot Radio & Tube Corporation
 Lawrence, Mass.

Please send me complete information about:

- The new SUPER-WASP
- The 4-tube Converter
- I enclose 50c for one year's subscription to Radio Design beginning with the current issue.

Name City State